



THE UK'S LEADING TOWING AND TOURING COMPANY

Trailer Lighting & Towing Catalogue



Welcome....

...to our comprehensive 'Trailer Lighting and Towing' catalogue. There are over 120 pages of new products, more product information, latest product images and drawings.

Towing Section

We have 30 pages filled with our latest towing electrics and hardware product, including brand new products in both ranges. We have added to our range of towballs, ball and pin hitches and a new towing jaw MP87, starting from page 30. We have also expanded our range of towing electrics to include 24v plugs, sockets and extension cables, these can be found on page 16.

Don't forget to look out for this symbol  for high quality European sourced products that are ideal for the professional fitter.

You Manufacture the Trailer, We Will Light It!

From page 37 read about how we can assemble trailer lighting harnesses in our own production facilities. We can offer bespoke solutions using

Terms & Conditions

Ordering

For all UK & Export orders contact our sales team by phone, email or fax.

Tel: +44 (0)121 270 4301

Email: sales@maypoleltd.co.uk

Fax: +44 (0)121 423 3020

UK Delivery Charges

Orders to the UK over £250 are carriage free. Orders under this amount will incur the following charges:

- 2-3 working days £8.95
- Next day £11.95 (*excluding Northern Ireland, Channel Islands & Highlands. Must be ordered before 12pm & 5 items or less*).
- Standard Royal Mail postage £4.00

For orders to the Channel Islands, the minimum order value is £500, please call for a carriage quotation.

Northern Ireland & Ireland Delivery Charges

Orders over £300 / €350 are carriage free. Orders to Ireland under £300 / €350 will incur a carriage charge of £18.95.

Export Deliveries

All prices quoted are ex-works, quotations for delivery are available upon request.

Payment Terms

Maypole Ltd are suppliers to the trade only. Orders can only be placed with us when a trade account has been opened, the value of the first order must be over £250.

SuperSeal or quick-connect connectors, AJ.BA or Radex connectors. Our technical team can give you the advice you need for the best harness solution for your trailer.

For nearly 50 years we have been manufacturing a wide range of trailer lighting boards. From page 95 we list our most popular boards, but don't forget we can make a board bespoke to your needs.

Lighting

We offer a wide selection of LED and bulb lamps, including top brands Radex, Britax, AJ.BA and Trucklite. We have expanded our range of LED lamps to respond to the demand in the market.

Our range of beacons and work lamps have increased and we have introduced new light bars, from page 116. From page 118 we have added LED interior lamps suitable for vans, welfare units and caravans.

The Maypole Team

Payments for goods is due no later than 30 days after the delivery date or date of deemed delivery. Maypole reserve the right to close the account if the minimum annual spend of £1000 P.A has not been achieved. Title of goods remains with Maypole Ltd until paid for in full.

Returns

While we constantly strive to deliver quality items, faulty goods with manufacturing defects can be returned to Maypole by contacting our returns team. Customers wishing to stock cleanse and return goods for other reasons must contact the sales team for authorisation first and then return at their own expense. A 20% handling charge will be deducted. Returns will only be accepted when a Maypole returns note has been completed stating reasons for the return.

Delivery shortages, invoice queries and damaged products MUST be reported within 3 working days of date of delivery.

Maypole reserve the right to change prices and charges without prior notice.

Full terms and conditions can be found on the inside of the back cover of this catalogue.

Full Marketing support is available for images, text and technical information. Please email marketing@maypoleltd.co.uk.

Contents

	Towing Electrics Cable, Cable Accessories, Extension Leads & Junction Boxes	4 - 9
	Plugs & Sockets Conversion Adaptors, 12 & 24V Plugs & Sockets	10 - 21
	Towbar Wiring Towbar Wiring Kits, Socket Mounting Plates, Relays, Towbar Testers	22 - 32
	Towing Hardware Towballs, Ball & Pin Hitches & Towing Hardware	33 - 39
	Trailer Lighting Harness Trailer Lighting Solutions, SuperSeal Harness, Radex & AJ.BA Harnesses & Lamps	40 - 60
	LED Vehicle Lamps Markers, Outline Markers, Combination, Reverse, Fog & Numberplate Lamps	61 - 79
	Bulb Vehicle Lamps Markers, Outline Markers, Combination, Reverse, Fog & Numberplate Lamps	80 - 96
	Truck-Lite	97 - 101
	Trailer Lighting Boards Trailer Lighting Pods, LED, LED Varivolt, Standard, Cycle Carrier Boards	102 - 109
	Reflectors	110- 112
	Beacons & Work Lamps Beacons, Work Lamps, Strobes & Light Bars	113 - 126
	Interior Lamps LED & Bulb	127 - 130

Product descriptions, images and text may change without prior notice.

Cable

Automotive and Trailer Cable

SINGLE CORE CABLE

- Suitable for 12v and 24v
- PVC insulated, gives good resistance to abrasion
- Ideal for automotive, marine and allied industries
- 50m roll



Colour	1 x 1.0mm ²	1 x 2.0mm ²
	8 amp	17 amp
Black	MP3222B	
Black		MP3224B
Red		MP3224R

AUTOMOTIVE STARTER SINGLE CABLE

- Single insulated battery / starter cable
- PVC insulated
- 10m roll



Colour	1 x 25mm ²
	170 amp
Black	MP3365B
Red	MP3365R

TWIN CABLE FLAT

- Suitable for 12/24v circuits
- PVC insulated
- Core colours; red and black



Roll	2 x 0.65mm ²	2 x 1.0mm ²	2 x 2.0mm ²	2 x 2.5mm ²
	5 amp	8 amp	17 amp	25 amp
30m Roll	MP316	MP313	MP314	
100m Roll		MP310	MP311	MP3151

TWIN CORE SPEAKER CABLE

- PVC insulated
- Twin cable for wiring speaker systems in vehicles or at home
- 30m roll



Size	2 x 0.38mm ²
	2 amp
	Black/White
Black/White	MP3121

Cable

7 CORE BLACK CABLE

- PVC insulated
- Inner core colours: Yellow, Blue, White, Green, Brown, Red and Black
- Please note the single core measurement is White
- Ideal for 12N applications
- Suitable for automotive and allied industries



Roll	6x0.4mm ² +1x0.65mm ²	7x0.50mm ²	7x0.65mm ²	6x0.5mm ² +1x0.65mm ²	6x0.65mm ² +1x1.0mm ²	6 x 1mm ² + 1 x 2mm ²
	5 amp	4 amp	5 amp	5 amp	5 amp	8 amp
30m Roll			MP326			
100m Roll	MP323	MP324	MP325	MP318	MP327	MP328

5 CORE GREY AUXILIARY CABLE

- Ideal for 12S Type applications
- PVC insulated
- Inner core colours: Yellow - 1.5mm²
White, Green, Red and Black - 2.5mm²



Outer Colour	1 x 1.5mm ² + 4 x 2.5mm ²
	21 amp
Grey	MP3295

7 CORE GREY AUXILIARY CABLE

- Ideal for 12S Type applications
- PVC insulated
- Inner core colours: White - 2.5mm²
Yellow, Blue, Green, Brown, Red and Black - 1.5mm²

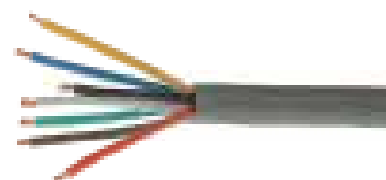

Roll	6 x 1.5mm ² + 1 x 2.5mm ²
	21 amp
30m Roll	MP331
100m Roll	MP329

8 CORE CABLE

- Ideal for 8-13 pin trailer applications with reverse lights where auxiliary battery charging is not required
- Inner core colours: Yellow, Blue, White, Green, Brown, Red, Black and Pink
- Please note the single core measurement is White
- PVC insulated
- 100m roll



Outer Colour	7 x 0.65mm ² + 1 x 1.5mm ²	7 x 0.50mm ² + 1 x 1.0mm ²
	8 amp	15 amp
Black	MP319	MP3195

Cable, Cable Connectors & Accessories

12 CORE CABLE

- Ideal for 13 pin towing electrics
- Inner core colours:
 Yellow, Blue, Green, Brown, Red, Black, Brown, Dark Red - 0.65mm²
 White - 1.50mm²
 Orange, Black & White, Red & White, Grey - 2.50mm²
- PVC insulated
- 50m roll



Outer Colour	7 x 0.65mm ² + 1 x 1.5mm ² + 4 x 2.5mm ²
	5 amp + 12 amp + 21 amp
Black	MP305

SNAP CONNECTORS



	Suitable for Cable	Display Pack	Bulk Pack
3M Scotchlock™ connector	0.75-1.5mm ²	MP398 (Per 6)	MP98B (Per 500)
Blue snap connector	0.75-1.5mm ²		MP93B (Per 1000)
Red snap connector	0.5-1.0mm ²		MP193B (Per 1000)

BLADE FUSES



	Bulk Pack	Pack Qty
15 amp	MP3015B	50
25 amp	MP3025B	50

INLINE FUSE HOLDER

- Inline fuse holder with screw terminals supplied with 1 continental fuse

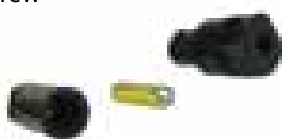

	Bulk Pack	Pack Qty
(0.65mm ² - 2.0mm ²) 5 amp	MP378B	20

BLADE FUSE HOLDER



	Bulk Pack	Pack Qty
(0.65mm ² - 2.0mm ²) 20 amp	MP384B	100

INLINE BLADE FUSE HOLDER

- Individual fuse holder suitable for ATO/ATC blade fuses. The cable connections are made via 2 x 6.3mm blade terminals. Continuous rating of 21 amps



Bulk Pack	Pack Qty
MP33701B	100

BLADE & MINI BLADE FUSE TAP

- Designed to provide an additional fused feed in a blade fuse box. 10 amps



Bulk Pack	Type	Pack Qty
MP33702B	ATO/ATC Blade	2
MP33703B	ATO/ATC Mini	2

HEAT SHRINK TERMINALS

- Creates a water resistant crimped join between cables when heated



	Bulk Pack	Pack Qty
0.5mm ² - 1.5mm ² Red	MP392B	100
0.5mm ² - 1.5mm ² Blue	MP393B	100

13 Pin Leads

13 Pin (8 Pin) Leads

We offer a wide range of extension leads from 13 Pin, 8 Pin and 7 Pin. All leads supply lighting functionality to trailers. If you don't find what you need, please contact the sales team with your specification. All assemblies are ISO compliant.

8 PIN STRAIGHT CONNECTING LEADS - PLUG TO PLUG

- 2 x 8 Pin plugs with 8 core cable
- Complies with ISO11446

Length	Code
1.5m	MP5890
2m	MP5897
2.5m	MP5898
3m	MP5892



8 PIN CURLY CONNECTING LEADS - PLUG TO PLUG

- 2 x 8 Pin plugs with 8 core curly cable
- Complies with ISO 11446

Working Length	Code
1.5m	MP5893
2.5m	MP5891
3m	MP5894



7 TO 8 PIN CONVERSION LEADS - PLUG TO PLUG

- 7 Pin plug to 8 Pin (13 Pin type) plug with 7 core cable
- Other sizes available by request

Length	Type	Code
2m	Straight	MP5907
3m	Straight	MP5902
2.5m	Curly	MP5901



8 PIN STRAIGHT EXTENSION LEADS (PLUG TO SOCKET)

- 8 Pin plug & 13 Pin flying socket with 8 core cable
- Complies with ISO 11446
- Trailer lighting functions only

Length	Code
3m	MP58587
6m	MP58095



8 PIN CURLY EXTENSION LEAD (PLUG TO SOCKET)

- 8 Pin plug & 8 Pin flying socket with 8 core curly cable
- Complies with ISO 11446
- Trailer lighting functions only

Working Length	Code
2.5m	MP5896



7 Pin Leads

7 Pin Leads

7 PIN STRAIGHT CONNECTING LEADS (PLUG TO PLUG)

- 2 x 7 Pin plugs with 7 core cable
- Complies with ISO 1724

Length	Code
1.5m	MP5880
2m	MP5887
2.5m	MP5888
3m	MP5882
3.5m	MP5883



7 PIN CURLY CONNECTING LEADS (PLUG TO PLUG)

- 2 x 7 Pin plugs with 7 core curly cable
- Complies with ISO 1724

Working Length	Code
1.5m	MP588
2.5m	MP5881
3m	MP5884



7 PIN STRAIGHT EXTENSION LEAD (PLUG TO SOCKET)

- 7 Pin plug & 7 Pin flying socket with 7 core straight cable
- Complies with ISO 1724
- Display packed in a re-useable zip bag

Length	Code
3m	MP587
6m	MP95



7 PIN N TYPE CURLY EXTENSION LEAD (PLUG TO SOCKET)

- 7 Pin plug and 7 Pin flying socket with 7 core curly cable
- Complies with ISO 1724

Working Length	Code
1.5m	MP5885
2.5m	MP5886



7 PIN S TYPE CURLY EXTENSION LEAD (PLUG TO PLUG)

- 2 x 7 Pin plugs with 7 core curly cable
- Supplementary caravan circuits
- Complies with ISO 3732

Working Length	Code
1.5m	MP589



Connecting Leads & Junction Boxes

Connecting Lead

TRAILER FRONT HARNESSSES (PLUG TO SPADE TERMINALS)

- 7 Pin and 13 Pin options with insulated spade terminals
- Suitable as replacement for Ifor Williams trailers
- Pre-wired front cable assembly, connects into the front junction box on horsebox and livestock trailers
- Curly cable is flexible and durable
- 4m flexible connecting lead with 2m tail



	Code
7 Pin	MP5909
8 Pin (13 Pin Type Plug)	MP5908

Junction Boxes

8 WAY JUNCTION BOX



- 8 way junction box mounted in a waterproof rubber base (Britax 3540.00)
- Screw terminals
- 15 amp rating



Display Pack	Bulk Pack
MP299	MP299B

ECONOMY 10 WAY JUNCTION BOX

- Economy 10 way junction box with screw down lid
- Screw terminals



Display Pack	Bulk Pack
MP2991	MP2991B

10 WAY JUNCTION BOX



- 10 way junction box for 12v & 24v applications (Britax E05.00)
- Spade terminals
- As fitted by leading trailer manufacturers



Display Pack	Bulk Pack
MP298	MP298B

10 WAY JUNCTION BOX



- 10 way junction box for 12v & 24v applications
- Spade terminals
- Complete with fixings and selection of cable entry and blanking grommets



Display Pack	Bulk Pack
-	MP2985B

Conversion Adaptors

12V Conversion Adaptors & Leads

With the change from the traditional 12N and 12S system to the 13 Pin system, the 12V connections on many towing and towed vehicles don't match. This is simply resolved by the use of a converter. This can take the form of a wired assembly or a conversion adaptor. All our 12N connectors conform to ISO 1724, our 12S connectors conform to ISO 3732 and our 13 Pin connectors conform to ISO11446.

- No need for expensive rewiring
- Easy to fit, use and store

To Convert a 12N Socket into a 8 Pin Trailer Socket

ADAPTOR 7 PIN VEHICLE TO 13 PIN TRAILER

- For the connection of a trailer equipped with a 13 Pin plug to a towing vehicle equipped with a 7 Pin 12N socket
- Provides a connection for 12N road lighting functions (excl. reverse)



Model Type	Pins	Bulk Pack	Bulk Pack Qty	Display Pack
Plastic Mini Adaptor Block	Brass	MP6005B	10	MP6005

JAEGER ADAPTOR 7 PIN CAR/VEHICLE TO 13 PIN CARAVAN/TRAILER

- Sourced from the EU
- Allows connection of a 13 pin trailer to a 7 pin equipped vehicle
- Light functions only
- Provides basic lighting functions, but not reverse (12N only)
- With weatherproof spring-loaded cap



Model Type	Pins	Bulk Pack	Display Pack
Plastic Mini Adaptor Block with Cap	*Nickel Plated	MP6002B	-

PROFESSIONAL ADAPTOR 7 PIN CAR/VEHICLE TO 13 PIN CARAVAN/TRAILER

- Sourced from the EU
- Allows connection of an 8/13 Pin trailer to a 7 Pin 12N vehicle
- Provides basic lighting functions only



Model Type	Pins	Bulk Pack	Display Pack
Plastic Mini Adaptor Block	*Nickel Plated	MP600B	MP600

* Nickel plated pins can provide better electrical connection and superior corrosion resistance than standard brass pins

Conversion Adaptors

To Convert a 12N & 12S Socket into a 13 Pin Socket

ADAPTOR 7 PIN 12N & 12S VEHICLE TO 13 PIN TRAILER

- Conversion lead with 2x7 Pin plugs (12N & 12S) and a 13 Pin socket
- Provides a connection for full road lighting and caravan power supplies
- 30cm cable



Model Type	Plug Pins	Socket Pins	Cables Used	Overall Length	Bulk Pack	Display Pack
Wired Adaptor Assembly	Brass	Nickel Plated	MP325 & MP3295	450mm	-	MP602

To Convert a 13 Pin Socket into a 12N 7 Pin Socket

ADAPTOR 13 PIN VEHICLE TO 7 PIN TRAILER

- For the connection of a trailer equipped with a 7 Pin 12N plug to a towing vehicle equipped with a 13 Pin socket
- Provides a connection for road lighting functions (excl. reverse)
- With weatherproof spring-loaded cap



Model Type	Pins	Bulk Pack	Bulk Pack Qty	Display Pack
Plastic Mini Adaptor Block with Cap	Brass	MP6015B	10	MP6015

PROFESSIONAL ADAPTOR 13 PIN CAR/VEHICLE TO 7 PIN CARAVAN/TRAILER

- Sourced from the EU
- Allows connection of a 7 Pin trailer to a 13 Pin equipped vehicle
- Provides basic lighting functions only
- With weatherproof spring-loaded cap



Model Type	Pins	Bulk Pack	Display Pack
Plastic Mini Adaptor Block with Cap	Nickel Plated	MP601B	MP601

To Convert a 13 Pin Socket into a 12N & 12S 7 Pin Sockets

ADAPTOR 13 PIN VEHICLE TO 7 PIN 12N & 12S TRAILER

- Conversion lead with 13 Pin plug and 2x7 Pin sockets (12N & 12S)
- Provides a connection for full road lighting and caravan power supplies
- 30cm cable



Model Type	Plug Pins	Socket Pins	Cables Used	Overall Length	Bulk Pack	Display Pack
Wired Adaptor Assembly	*Nickel Plated	Brass	MP325 & MP3295	450mm	-	MP603

Conversion Adaptors & Plugs & Sockets

PROFESSIONAL ADAPTOR 13 PIN PLUG TO 2 X 7 PIN SOCKETS



- Universal adaptor is ideal for connecting trailers and caravans with 12N & 12S 7 Pin connectors
- Features a bayonet coupling with lever that locks the 13 Pin socket to the vehicle
- Complies with ISO 11446 (13P) ISO 1724 (12N) and ISO 3732 (12S)
- Patented, compact design
- Sourced from the EU
- Reduces damage potential by not having trailing leads
- Retail box with instructions



Model Type	Plug Pins	Socket Pins	Overall Length	Bulk Pack	Display Pack
Plastic Compact Adaptor Block with Cap	Nickel Plated	Nickel Plated	90mm		MP6035

13 & 8 Pin 12V Connectors

13 & 8 pin European style plugs and sockets are increasingly replacing the traditional 12V Normal (N) and Supplementary (S) 7 pin system. This change is due to type approval Regulation 48 stipulating that all braked trailers and caravans, as well as all trailers over 6m in length, must be fitted with reverse lights.

13 pin connectors are widely used in caravan applications with auxiliary power and charging circuits. These circuits have been removed from our 8 pin connectors, which are therefore more cost effective for trailer applications.

As a single connector now incorporates all the functions that previously required two, space is saved and installation is simpler. 13 & 8 pin connectors also feature a twist and lock system that is more secure than the 7 pin system and its integral rubber seals resist water ingress more effectively, resulting in a longer lifespan.

All our 13 & 8 pin plugs and sockets comply with ISO 11446. Please visit page 133 for the wiring scheme.

13 Pin Plugs

12V 13 PIN PLASTIC PLUG

- Complies with ISO 11446



Number of Pins	Pin Style	Cable Entry Diameter (mm)	Bulk Pack	Bulk Pack Qty	Display Pack
13	*Nickel Plated with screw terminals		MP128B	10	MP128

* Nickel plated pins can provide better electrical connection and superior corrosion resistance than standard brass pins

Plugs & Sockets

12V 13 PIN PLASTIC PLUG WITH CAP

- Complies with ISO 11446
- Single cable entry gasket for cable sizes 8 to 15mm
- The plug is also water resistant and has a cable clamp for strain relief
- Supplied with green alignment cap MP1280B



Number of Pins	Pin Style	Cable Entry Diameter (mm)	Bulk Pack	Display Pack
13	*Nickel Plated with screw terminals		MP128MB	-

12V 13 PIN TWIN CABLE CONVERSION PLUG

- For conversions of caravans fitted with 12N & S wiring
- Instructions included



Number of Pins	Pin Style	Cable Entry Diameter (mm)	Bulk Pack	Bulk Pack Qty	Display Pack
13	*Nickel Plated with screw terminals		MP124B	10	MP124

12V 8 PIN PLASTIC PLUG (13 PIN TYPE PLUG)

- Complies with ISO 11446
- Suitable for trailers
- Can receive a single 8 core cable
- Single hole 9mm grommet
- Bulk pack qty 10



Number of Pins	Pin Style	Cable Entry Diameter (mm)	Bulk Pack	Bulk Pack Qty	Display Pack
8	*Nickel Plated with screw terminals		MP1288B	10	-

8/13 PIN ALIGNMENT CAP

- Suitable for use with all Maypole 8 and 13 Pin plugs
- Can be used to re-align the plug prior to connection
- Water tight seal keeps plug pins dry when the caravan is in storage or parked
- Also suitable for use as a plug keeper
- Bulk pack qty 10



Display Pack	Bulk Pack
MP1280	MP1280B

Plugs & Sockets

13 Pin Sockets

13 PIN PLASTIC SOCKET

- Complies with ISO 11446
- Supplied with socket seal and MP99FB



Body Style	Pins	Rear Gasket Included	Bulk Pack	Bulk Pack Qty	Display Pack
Plastic	*Nickel Plated with screw terminals	MP99FB	MP1293B	10	MP1293

PROFESSIONAL 12V 13 PIN PLASTIC SOCKET

- Complies with ISO 11446
- Supplied with socket seal
- Sourced from the EU



Body Style	Pins	Rear Gasket Included	Bulk Pack	Bulk Pack Qty	Display Pack
Plastic	*Nickel Plated with screw terminals	MP99FB	MP129B	10	MP129

12V 13 PIN PLASTIC SOCKET

- Complies with ISO 11446
- For conversion of towing vehicles fitted with 12N & S wiring



Body Style	Pins	Rear Gasket Included	Bulk Pack	Bulk Pack Qty	Display Pack
Plastic	*Nickel Plated with screw terminals	MP99TFB	MP129TFB	10	-

12V 13 PIN PLASTIC SOCKET WITH FOG CUT OUT

- Complies with ISO 11446
- With mechanical fog cut-off switch



Body Style	Pins	Rear Gasket Included	Bulk Pack	Bulk Pack Qty	Display Pack
Plastic	*Nickel Plated with screw terminals	MP99FB	MP1295B	10	-

Plugs & Sockets

Extension Sockets

12V 13 PIN FLYING SOCKET

- Complies with ISO 11446
- Complete with wiring instructions
- Ideal for making extension cables
- Can receive 12 or 8 core cable



Number of Pins	Pin Style	Cable Entry Diameter (mm)	Bulk Pack	Bulk Pack Qty	Display Pack
13 Pin socket with rear trumpet base	*Nickel Plated with screw terminals		MP125B	10	-

8 PIN EXTENSION LEAD SOCKET

- Ideal for making extension and conversion leads or repair to existing cables
- Durable design with integrated hook



Number of Pins	Pin Style	Cable Entry Diameters (mm)	Bulk Pack	Display Pack
8 Pin flying socket	Brass with screw terminals		MP1318B	MP1318

7 Pin 12V Connectors

The 12V Normal (N) and Supplementary (S) 7 pin connection system has been used in the UK for many years. Whilst being gradually superseded by the 13 pin system, this traditional system still remains widely used.

The 12N system connects all lighting functions, with the exception of reverse, which is part of the 12S system. The 12S system also connects a caravan's charging circuits.

All our 12N connectors conform to ISO 1724 and our 12S connectors conform to ISO 3732. Please visit page 133 for the wiring scheme.

12N Plugs

12N TYPE 7 PIN PLASTIC PLUG

- Designed to conform to ISO 1724
- Brass pins



Body Style	Pin Style	Cable Entry Diameters (mm)	Bulk Pack	Bulk Pack Qty	Display Pack
Plastic Clip-close	*Brass Pins with screw terminals		MP21B	10	MP21

* Nickel plated pins can provide better electrical connection and superior corrosion resistance than standard brass pins

Plugs & Sockets

PROFESSIONAL 12N 7 PIN PLASTIC PLUGS

- Manufactured in Europe
- Designed to conform to ISO 1724



Body Style	Pin Style	Cable Entry Diameters (mm)	Bulk Pack	Bulk Pack Qty	Display Pack
Plastic Clip-close	Brass with screw terminals		MP21MB	10	-
Plastic Clip-close	*Nickel Plated with screw terminals		MP21NB	10	MP21N

12N TYPE 7 PIN ALUMINIUM PLUG

- Robust aluminium body
- Designed to conform to ISO 1724



Body Style	Pin Style	Cable Entry Diameters (mm)	Bulk Pack	Bulk Pack Qty	Display Pack
Aluminium Screw-close	Brass Plated with screw terminal		MP24B	10	MP24

12N TYPE 7 PIN ALUMINIUM PLUG

- Robust aluminium body
- Designed to conform to ISO 1724
- Manufactured in Europe



Body Style	Pin Style	Cable Entry Diameters (mm)	Bulk Pack	Bulk Pack Qty	Display Pack
Aluminium Screw-close	*Nickel Plated with screw terminals		MP24NB	10	-

Plugs & Sockets

12S Plugs

12S TYPE 7 PIN PLASTIC PLUG

- Designed to conform to ISO 3732
- Ideal for caravans



Body Style	Pin Style	Cable Entry Diameters (mm)	Bulk Pack	Bulk Pack Qty	Display Pack
Plastic Screw-close	Brass Plated with screw terminals	8-10	MP29B	10	MP29B

12N Sockets

12N TYPE 7 PIN PLASTIC SOCKET

- Designed to conform to ISO 1724



Body Style	Pins	Requires Rear Gasket	Bulk Pack	Bulk Pack Qty	Display Pack
Plastic	Brass with screw terminals	MP99B	MP23B	10	MP23

PROFESSIONAL 12N 7 PIN PLASTIC SOCKETS

- Manufactured in Europe
- Designed to conform to ISO 1724
- MP26B features mechanical fog cut-off switch



Body Style	Pins	Requires Rear Gasket	Bulk Pack	Bulk Qty Pack	Display Pack
Plastic	Brass with screw terminals	MP99B	MP23MB	10	-
Plastic	*Nickel Plated with screw terminals	MP99B	MP23NB	10	-
Plastic	Brass with screw terminals	MP99B	MP26B	-	-

Plugs & Sockets

12N TYPE 7 PIN ALUMINIUM SOCKET

- Robust aluminium body
- Designed to conform to ISO 1724



Body Style	Pins	Requires Rear Gasket	Bulk Pack	Bulk Qty Pack	Display Pack
Aluminium	Brass with screw terminals	MP99FB	MP25B	10	MP25
Aluminium	*Nickel Plated with screw terminals	MP99B	MP25NB	10	-

12S Socket

12S TYPE 7 PIN PLASTIC SOCKET

- Designed to conform to ISO 3732
- Ideal for caravans
- Brass pins



Body Style	Pins	Requires Rear Gasket	Bulk Pack	Bulk Qty Pack	Display Pack
Plastic	Brass with screw terminals	MP68B	MP31B	10	MP31

12N Extension Socket

12N TYPE 7 PIN PLASTIC FLYING SOCKET

- Designed to conform to ISO 1724
- Ideal for making extensions



Body Style	Pin Style	Cable Entry Diameters (mm)	Bulk Pack	Bulk Pack Qty	Display Pack
Plastic Screw-close	Brass Plated with screw terminals		MP131B	10	MP131

12S Extension Socket

12S TYPE 7 PIN PLASTIC FLYING SOCKET

- Designed to conform to ISO 11446
- Ideal for making extensions



Body Style	Pin Style	Cable Entry Diameters (mm)	Bulk Pack	Bulk Pack Qty	Display Pack
Plastic Screw-close	Brass Plated with screw terminals		MP132B	10	-

Plugs & Sockets

24N Plug

24N 7 PIN PLASTIC PLUG

■ Conforms to ISO 1185



Body Style	Pin Style	Cable Entry Diameters (mm)	Bulk Pack	Display Pack
Plastic	*Nickel Plated with screw terminals	11.5	MP1223B	-

24N 7 PIN ALUMINIUM PLUG

■ Conforms to ISO 1185

■ Robust aluminium alloy construction



Body Style	Pin Style	Cable Entry Diameters (mm)	Bulk Pack	Display Pack
Aluminium	*Nickel Plated with screw terminals	11.5	MP122B	-

24S Plug

24S 7 PIN PLASTIC PLUG

■ Complies with ISO 3731



Body Style	Pin Style	Cable Entry Diameters (mm)	Bulk Pack	Display Pack
Plastic	*Nickel Plated with screw terminals	13.5	MP1225B	-

24N Socket

24N 7 PIN PLASTIC SOCKET

■ Conforms to ISO 1185



Body Style	Pin Style	Cable Entry Diameters (mm)	Bulk Pack	Display Pack
Plastic	*Nickel Plated with screw terminals	11.5	MP1263B	-

Plugs & Sockets

24N 7 PIN ALUMINIUM SOCKET

■ Conforms to ISO 1185



Body Style	Pin Style	Cable Entry Diameters (mm)	Bulk Pack	Display Pack
Aluminium	*Nickel Plated with screw terminals	11.5	MP126B	-

24S Socket

24S 7 PIN PLASTIC SOCKET

■ Conforms to ISO 3731



Body Style	Pin Style	Cable Entry Diameters (mm)	Bulk Pack	Display Pack
Plastic	*Nickel Plated with screw terminals	13.5	MP1265B	-

EBS Plug & Socket

7 PIN EBS PLASTIC PLUG

■ Complies with ISO 7638



Body Style	Pin Style	Cable Entry Diameters (mm)	Bulk Pack	Display Pack
Plastic	*Nickel Plated with screw terminals	15.5	MP1271B	-

7 PIN EBS PLASTIC SOCKET

■ Conforms to ISO 7638



Body Style	Pin Style	Cable Entry Diameters (mm)	Bulk Pack	Display Pack
Plastic	*Nickel Plated with screw terminals	15.5	MP1275B	-

24V Connecting Leads

24V Spiral Connecting Leads

4M ABS/EBS 7 PIN PLUG TO PLUG SPIRAL INTERCONNECTION CABLE

- ISO 7638
- Intended for 24V ABS and EBS connections

Bulk Pack
MP5844



3.5M 15 PIN SOCKET TO 24N & 24S PLUG SPIRAL INTERCONNECTION CABLE

- 15 Pin socket ISO 12098
- 24N plug ISO 1185
- 24S plug ISO 3731

Bulk Pack
MP5847



3.5M 24N PLUG TO 24N PLUG SPIRAL INTERCONNECTION CABLE

- ISO 1185
- Best suited to LED lighting applications

Bulk Pack
MP5863



3.5M 24S PLUG TO 24S PLUG SPIRAL INTERCONNECTION CABLE

- ISO 3731
- Suitable for low load charging and small auxiliary supplies

Bulk Pack
MP5865



3.5M 24N PLUG TO 24N PLUG HEAVY DUTY SPIRAL INTERCONNECTION CABLE

- ISO 1185
- Ideal for more demanding lighting applications

Bulk Pack
MP5864



3.5M 24S PLUG TO 24S PLUG HEAVY DUTY SPIRAL INTERCONNECTION CABLE

- ISO 3731
- Perfect for high current auxiliary loads and larger capacity charging requirements

Bulk Pack
MP5866



Socket Mounting Plates

Socket Mounting Plates

SINGLE SOCKET MOUNTING PLATE

- Suitable for 12N or 12S applications
- Corrosion resistant ED coating



Display Pack	Bulk Pack
MP88	MP88B

SINGLE SOCKET MOUNTING PLATE

- Ideal for retrofitting 7 or 13 Pin sockets
- Heavy duty 2.0mm steel
- Corrosion resistant ED coating



Bulk Pack
MP86B

DUAL MOUNTING PLATE

- Suitable for 12N or 12S applications
- Corrosion resistant ED coating



Bulk Pack
MP188B

DUAL SOCKET MOUNTING PLATE

- Suitable for 12N or 12S applications
- Corrosion resistant ED coating



Display Pack	Bulk Pack
MP92	MP92B

SWAN NECK MOUNTING PLATE

- Suitable for 7/13 Pin applications



Bulk Pack
MP807B

QUICK FIT ADAPTOR PLATE

- Ideal for retrofitting 7 or 13 Pin sockets
- Suitable for S Type conversion
- 2.0mm thickness



Display Pack	Bulk Pack
MP8071	MP8071B

RIGHT ANGLE SOCKET ADAPTOR PLATES

- MP8075B is suitable for retrofitting 7 or 13 Pin sockets
- Robust stainless steel material is heavy duty and ideal for marine use

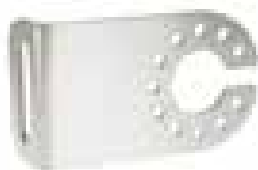

MP8075B



MP80755B

Bulk Pack (Slot)	Bulk Pack (Without Slot)
MP8075B	MP80755B

TOWSTEP SOCKET MOUNTING PLATE

- Slot allows for 7/13 Pin sockets to be retrofitted
- Suitable for MP346



Bulk Pack
MP3465B

Towbar Wiring

13 Pin Towbar Wiring With Sheathed Cable

Assembled in the UK. Sheathed cable offers more flexibility especially when used on swan neck towbars. It is easier to strip and work with. We offer various lengths from 1.5m and mounting plate options. The professional fitters versions use European quality socket MP129B.

PROFESSIONAL 13 PIN SOCKET ASSEMBLY

- Pre-wired socket with 12 core sheathed cable and flexible gasket plus 3 fixing bolts

Cable Length	Display Pack	Bulk Pack
1.5m	MP8080	MP8080B
2m		MP8080B2M



PROFESSIONAL 13 PIN SOCKET ASSEMBLY WITH MOUNTING PLATE

- Pre-wired socket with 12 core sheathed cable and flexible gasket plus 3 fixing bolts

Cable Length	Bulk Pack
2m	MP8079B2M



13 Pin Towbar Wiring

PROFESSIONAL 13 PIN SOCKET ASSEMBLY

- Comes with 12 core cable, gasket and bolts
- Instructions included

Cable Length	Bulk Pack
1.5m	MP8085B
2m	MP8085B2M
2.5m	MP8085B2.5M



Towbar Wiring

PROFESSIONAL 13 PIN SOCKET ASSEMBLY WITH MOUNTING PLATE

- Comes with 12 core cable, gasket and bolts
- Instructions included



Cable Length	Bulk Pack
1.5m	MP8086B
2m	MP8086B2M



PROFESSIONAL 13 PIN (8 CORE) SOCKET ASSEMBLY

- Comes with 8 core cable, gasket and bolts
- Ideal for trailer road lighting



Cable Length	Bulk Pack
2m	MP8084B2M



13 PIN 12N & 12S SOCKET ASSEMBLY WITH TWIN HOLE GASKET

- Pre-wired 12N & 12S socket with 2 x 7 core cable and twin hole gasket
- Converts vehicles fitted with 12N/S wiring to 13 Pin



Cable Length	Bulk Pack	Bulk Pack Qty
2m	MP8077B2M	10

Towbar Wiring

7 Pin Towbar Wiring

12N PRE-WIRED SOCKET ASSEMBLY

- Comes with 7 core cable and flexible gasket plus 3 fixing bolts



Cable Length	Bulk Pack	Box Qty
1.5m	MP808B	30
2m	MP808B2M	30
5m	MP808B5M	25

12N PRE-WIRED SOCKET ASSEMBLY ON SWAN NECK MOUNTING PLATE

- Comes with 7 core cable, gasket and swan neck mounting plate



Cable Length	Bulk Pack
1.5m	MP8081B

12S PRE-WIRED SOCKET ASSEMBLY WITH MOUNTING PLATE

- Supplied with 7 core cable, flexible gasket and metal plate



Cable Length	Display Pack	Bulk Pack	Bulk Pack Qty
1.5m	MP32	MP32B	10
2m		MP32B2M	25

12N PRE-WIRED SOCKET ASSEMBLY WITH MOUNTING PLATE

- Comes with 7 core cable, flexible gasket and mounting plate



Cable Length	Display Pack	Bulk Pack	Bulk Pack Qty
1.5m	MP27	MP27B	30
2m		MP27B2M	30

12N&S PRE-WIRED SOCKET ASSEMBLY WITH MOUNTING PLATE

- Pre-wired socket assembly with 2 x 7 core cable, flexible gaskets and metal plate



Cable Length	Display Pack	Bulk Pack
1.5m	MP94	MP94B
2m		MP94B2M

12S PRE-WIRED SOCKET ASSEMBLY

- Comes with 7 core grey auxiliary cable and flexible gasket plus 3 fixing bolts



Cable Length	Bulk Pack	Bulk Pack Qty
2m	MP809B2M	20

Towbar Wiring Kits

Towbar Wiring Kits With Audible Relay

Suitable for vehicles with constant rate direction indicator flasher units

12N WIRING KIT WITH AUDIBLE RELAY



Cable Length	Display Pack	Bulk Pack
1.5m	MP383	MP383B
2m		MP383B2M

12N & SWIRING KIT WITH AUDIBLE RELAY



Cable Length	Display Pack	Bulk Pack
1.5m	MP380	MP380B

Towbar Wiring Kits With 7 Way By-Pass Relay

Suitable for vehicles where direct connection of towing electrics may affect bulb failure monitoring, multiplex wiring or other electronic systems. Powered separately from the power circuits the device virtually draws no power from the lighting circuits.

7 PIN WIRING KIT WITH BYPASS RELAY + 1.5M MP318 7 CORE TRAILER CABLE

Kit Contents

7 Pin N&S Type Socket Assembly with Mounting Plate, 12v 7 Way Bypass Relay, 3m x 2.0mm 17 Amp Twin Cable Flat, 5m x 3.0mm 27 Amp Single Core Cable, 7 x Blue Snap Connectors, 2 x 6.4mm Blue Pre-insulated Ring Terminal, 1 x 8.4mm Yellow Pre-insulated Ring Terminal, 2 x 6.4mm Yellow Pre-insulated Blade Terminal, 1 x Inline Blade Fuse Holder, 1 x 15 Amp Blade Fuse

Bulk Pack

MP3837



12S WIRING KIT WITH 30A DUAL CHARGING RELAY + 2M MP329 7 CORE TRAILER CABLE

Kit Contents

7 Pin N&S Type Socket Assembly, 30 Amp Dual Charge Relay, 3m x 2.0mm 17 Amp Twin Cable Flat, 5m x 3.0mm 27 Amp Single Core Cable, 7 x Blue Snap Connectors, 2 x 6.4mm Blue Pre-insulated Ring Terminal, 1 x 8.4mm Yellow Pre-insulated Ring Terminal, 2 x 6.4mm Yellow Pre-insulated Blade Terminal, 1 x Inline Blade Fuse Holder, 1 x 15 Amp Blade Fuse

Bulk Pack

MP3811B



13 PIN WIRING KIT WITH 30A DUAL CHARGING RELAY + 2M 12 CORE BUNDLED CABLE

Kit Contents

30amp self switching dual charge relay, 12V 7 way bypass relay, 5m 2mm red core cable, 5m 3mm black core cable, 5m 2mm black trailer cable, 0.5m 0.75mm white core cable, 9 x blue snap connectors, 4 x yellow pre-insulated blade terminal, 4 x blue pre-insulated ring terminal, 2 x in-line blade fuse holder, 15amp blade fuse, 25amp blade fuse, yellow pre-insulated ring terminal

Bulk Pack

MP3814B



Towbar Wiring Accessories

Towbar Wiring Accessories

FLEXIBLE SOCKET SEAL

- Made from flexible PU
- Minimum order quantity 50

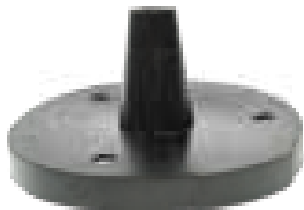

	Bulk Pack
N Type	MP99B
S Type	MP68B

SOCKET FIXING

- M5 x 35mm set screws with nuts



Display Pack	Bulk Pack
MP246 (Per 3)	MP245 (Per 100)

PVC SOCKET COVER

- 7 Pin and 13 Pin socket cover
- Helps to keep dirt and water out of socket
- Reduces corrosion



Display Pack	Bulk Pack
MP242	MP242B

FLAT SIDE SOCKET SEAL

- Ideal for 13 and 7 Pin electrics
- Made from flexible PU
- MP99FB minimum order quantity 50
- MP99TFB minimum order quantity 10



	Bulk Pack
Single Hole	MP99FB
Twin Hole	MP99TFB

N TYPE SOCKET SEAL

- With 3 fixing nuts & bolts M5 x 35mm



Display Pack
MP247

PVC PLUG & SOCKET COVER



	Display Pack	Bulk Pack
12N Plug Cover		MP137B
PVC plug & socket cover	MP243	

Relays

Audible / 'Tell-Tale' Relay

Audible relays buzz in time with the vehicle's indicators when connected. It is a legal requirement to have either a visual or audible monitor fitted so the driver is aware that the indicators are working on a trailer or caravan.

12V PROFESSIONAL AUDIBLE BUZZER

- Fitted at the rear of the vehicle the relay gives an audible signal that is in sequence with the towed vehicle's indicators / flashers
- Easy to conceal within the vehicle
- Excellent sound clarity; loud and high output
- Easy to read standard colour codes
- Instructions included



Display Pack	Bulk Pack
MP3870	MP3870B

Bypass Relays

Bypass relays are used to switch trailer and caravan lights on and off. The relay is connected to the lighting circuit and only draws a small current meaning it cannot be detected by bulb failure sensors in most vehicles. All bypass relays can be powered using either the battery or the fuse box. A fused 12v power supply required for installations.

12V AUDIBLE SENSOR WITH DOUBLE BYPASS & TELL-TALE

- Double bypass relay suitable for switching the towed vehicle's indicator / flasher circuits
- Also features an audible warning that buzzes in time with the indicator / flashers and tell-tale output
- Fly leads for connection to vehicle lighting circuits and screw terminals for output
- Made in the UK



Bulk Pack
MP3875B

12V 7 WAY BYPASS RELAY

A 7 way bypass relay is connected directly to the vehicle's lighting circuits to control the lights on a trailer and caravan. The relays do not put any extra load onto the vehicle's lighting system. The relays also feature a built in audible buzzer that monitors the trailer and caravan indicators.

- Works on most vehicle types and with most bulb & LED lamp combinations
- Differentiates circuits on dual voltage tail/brake and tail/fog systems
- Monitors indicators/flashers via the internal buzzer, which mutes under hazard warning conditions
- Ancillary flasher/indicator monitor output to panel lamp or additional buzzer
- MP3877B2M features 2m long sensor leads for all circuits
- Made in the UK

Display Pack	Bulk Pack
MP3877	MP3877B
	MP3877B2M



Relays

7 WAY BYPASS RELAY - 24V TO 12V

- Designed to bypass 24v vehicles and give a 12v trailer output, only with a fused 12v power supply
- Monitors indicators/flashers via the internal buzzer
- Ancillary flasher/indicator monitor output to panel lamp or additional buzzer



Bulk Pack

MP3879B

Electronic Bypass Relays

- Exclusive to Maypole ■ Compatible with LED lamps on a trailer ■ Only for 12v vehicles
- High quality relays made in Europe ■ Easier to replace if current relay is faulty

7 WAY ELECTRONIC BYPASS RELAY

- Fully electronic bypass, 1mA low current draw
- 7 way plug-in vehicle signal lead
- Indicator tell-tale output via 2 way plug to power external LED or buzzer and reset in the event of automatic cut out individual circuit overload
- 7 x screw terminal outputs
- Screw terminals for +12v and 0v inputs
- Accessories available



Display Pack

MP389

Bulk Pack

MP389B

7 WAY ELECTRONIC BYPASS RELAY WITH SEQUENTIAL FOG SWITCHING

- Fully electronic bypass, 1mA low current draw
- 8 way plug-in vehicle signal input lead
- Optional output for plug-in external buzzer or LED
- Optional output for plug in dual colour signal LED for trailer present and trailer fog light switching
- Automatic overload protection for each individual circuit
- Automatic detection of trailer connected (provides the following additional features subject to trailer lighting circuit conditions)
- Screw type output terminals for socket wiring
- Screw terminals for +12v and 0v inputs
- Sequential trailer fog lamp switching, allowing the towing vehicles fog lamp to be turned off while the trailer fog lamp is operating
- Audible reminder of trailer fog lamp operating
- Optional output for dual colour signal LED to indicate; trailer present and trailer fog light operating
- Switched 0v supply for parking distance control, allowing the reverse sensors of most vehicles to be disabled when a trailer is connected



Bulk Pack

MP390B

5M PLUG-IN AUDIBLE REPEATER

- Audible buzzer suitable for MP389B & MP390B relay
- 2 way plug with easy fit to connect to the relay
- 5m cable length



Bulk Pack

MP3892B

Relays

5M PLUG-IN LED REPEATER

- LED display suitable for MP389B & MP390B relay
- 2 way plug with easy fit to connect to the relay
- 5m cable length

Bulk Pack
MP3894B



PLUG-IN 8 WAY VEHICLE SIGNAL LEAD

- 8 way signal leads plug into a socket on the circuit board for MP389B & MP390B
- Easy to fit, easy to test circuits, easy to replace relay if required
- Provides an earth feed (2 amp) when trailer is not connected to supply parking sensor module on the car

Bulk Pack
MP3896B



Charging Relays

Charging relays are suitable for 12S electrics and will charge a caravan leisure battery and/or power the fridge, while the vehicle is running. It also protects the vehicle battery from drain when the engine is turned off.

20 AMP DUAL CHARGE RELAY

- Combination style ignition switched relay for leisure batteries
- Made in the UK
- Instructions included

Display Pack	Bulk Pack
MP288	MP288B



20 AMP SELF SWITCHING DUAL CHARGE RELAY

- Combination caravan relay with automatic voltage monitoring and switches the power supply from car to caravan
- No separate signal wire necessary
- Able to switch 20 amp continuously when available from car's alternator/battery
- Over temperature protection
- Line voltage drop compensation
- Made in the UK

Display Pack	Bulk Pack
MP2881	MP2881B



30 AMP SELF SWITCHING DUAL CHARGE RELAY

- Combination caravan relay with automatic voltage monitoring and switches the power supply from car to caravan
- No separate signal wire necessary
- Able to switch 30 amp continuously when available from car's alternator/battery
- Over temperature protection
- Line voltage drop compensation
- Made in the UK

Display Pack	Bulk Pack
MP2883	MP2883B



Smart Load Devices

Smart Load Devices

SMART LOAD DEVICE FOR 12V LED INDICATORS

- Suitable for 12v LED indicators 1.2-5.0 watt
- When the trailer LED indicators are working correctly, the relay provides a load to activate audible sensor or tell-tale circuits
- Two required per trailer
- Instructions included



Bulk Pack
MP388B

SMART LOAD DEVICE FOR 12/24V LED INDICATORS

- Suitable for 12/24v LED indicators 1.2-5.0 watt
- When the trailer LED indicators are working correctly, the relay simulates a load to activate audible sensor or tell-tale circuits
- Instructions included



Cable Length	Bulk Pack
4 x 2.5m	MP3885B
4 x 0.5m	MP3886B

12V 6 OHM 50W ALUMINIUM CASE LOAD RESISTOR

- In-line load resistor with aluminium heat-sink casing for trailer lighting circuits
- Intended for use in LED lighting installations to provide additional load to a single lighting circuit enabling it to be correctly recognized by the towing vehicle
- Voltage 12V
- Resistance 6Ω
- Max power consumption 50W
- Resin sealed for improved water resistance



Display Pack	Bulk Pack
MP3824	MP3824B

Relay Kit

CARAVAN DUAL CHARGE RELAY KIT (IGNITION SWITCHED)

- MP288B 20 amp dual charging relay
- 5m of 20 amp green power cable
- 5m of 5 amp blue sensor cable
- 0.2m of 5m white earth cable
- Blade fuse, fuse holder and ring terminal



Display Pack	Bulk Pack
MP292	MP292B

Towbar Testers & Miscellaneous

Towbar Testers

Perfect for checking all electrical circuits are working correctly after installation and before towing.

TOWBAR SOCKET TESTERS

- Suitable for 12v vehicles
- Note - circuits 8, 9 & 10 may not be present in all 13 Pin towbar applications
- 3.5m cable
- Lead allows testing from drivers seat

Type	Bulk Pack
13 Pin	MP1805B
7 Pin	MP180B

MP1805B



MP180B



13 PIN CAR AND TRAILER TESTER

- For testing ISO 11446/13 pin lighting & 12V power supply circuits
- LED indicators clearly show any faults
- Suitable for testing LED & filament bulb trailer lighting
- Requires 1 x 9V PP3 battery (not included)

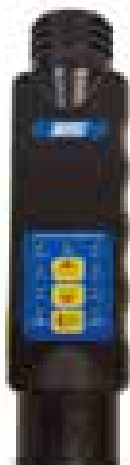

Bulk Pack
MP1802B

12N 7 PIN CAR AND TRAILER TESTER

- For testing ISO1724 /12N 7pin circuits
- LED indicators show any faults on the towbar or trailer lighting circuits
- Requires 1 x 9V PP3 battery (not included) for testing trailer lighting

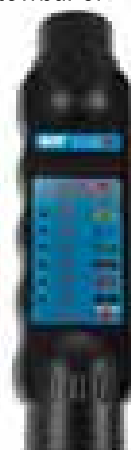

Bulk Pack
MP1804B

Miscellaneous

CABLE AND 5 MP93B BLUE SNAP CONNECTORS

- Used for wiring N Type towing electric sockets
- 1.5m MP325 7 core cable (7x0.65mm²) 5 amps



Bulk Pack
MP300

12V SINGLE POLE PLUG AND SOCKET

- Manufactured in Europe
- Plug comes with spade terminals
- Provides power inlet/outlet for auxiliary systems

	Bulk Pack
Plug	MP8471B
Socket	MP8472B



Towballs

Towballs

Regulation 55 has been introduced to replace EC94/20 towbar regulation. Regulation 55 is fundamentally similar to EC94/20, but with additional test and administration requirements.

EU APPROVED 50MM TOWBALL - GOLD

- Great value
- D Value = 17Kn S Value = 200Kg
- Standard 90mm fixing centres
- 2 x M16 mounting bolt fixing holes
- Approved to Reg 55
- Box quantity 10
- Pallet quantity 500

Bulk Pack
MP79

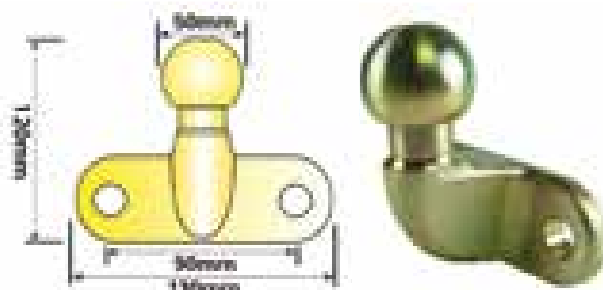

EU APPROVED HEAVY DUTY 50MM TOWBALL - SILVER

- D Value = 17.2Kn S Value = 350Kg
- Standard 90mm fixing centres
- 2 x M16 mounting bolt fixing holes
- Approved to Reg 55
- Box quantity 10
- Pallet quantity 500

Display Pack	Bulk Pack
MP500	MP500B

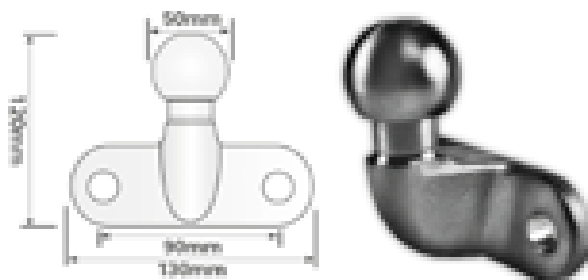

EU APPROVED HEAVY DUTY 50MM TOWBALL - BLACK

- D Value = 17.2Kn S Value = 350Kg
- Standard 90mm fixing centres
- 2 x M16 mounting bolt fixing holes
- Approved to Reg 55
- Box quantity 10
- Pallet quantity 500

Bulk Pack
MP5003B

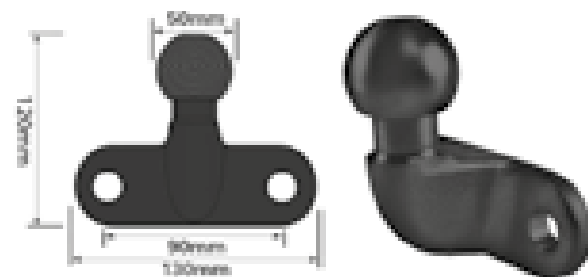

EU APPROVED HIGH REACH TOWBALL - BLACK

- Provides clearance for caravan couplings with integral stabilizer (e.g. ALKO)
- D Value = 17.2Kn S Value = 350Kg
- Standard 90mm fixing centres
- 2 x M16 mounting bolt fixing holes
- Approved to Reg 55
- Box quantity 10
- Pallet quantity 500

Bulk Pack
MP5005B



Ball & Pin Hitches

EU Approved Ball & Pin Hitches

50MM BALL AND PIN HITCH - SILVER

- Commonly fitted to 4x4s, pick-ups and commercial vehicles to allow hitch or towing eye trailers to be towed
- 90mm fixing centres
- Approved to Reg 55
- 2 x M16 mounting bolt fixing holes
- D Value = 20Kn S Value = 350Kg
- Box quantity 5
- Pallet quantity 150

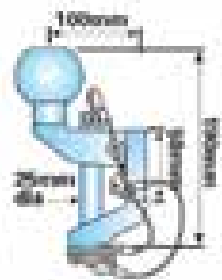
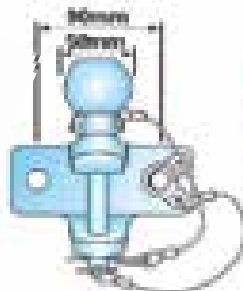

	Bulk Pack
Ball & Pin	MP82
Replacement Pin & Chain	MP494

50MM BALL AND PIN HITCH - BLACK

- Commonly fitted to commercial vehicles to allow hitch or towing eye trailers to be towed
- Approved to Reg 55
- 90mm fixing centres
- 2 x M16 mounting bolt fixing holes
- D Value = 20Kn S Value = 350Kg
- Box quantity 5
- Pallet quantity 150

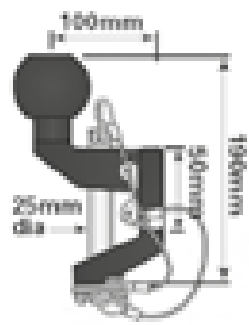
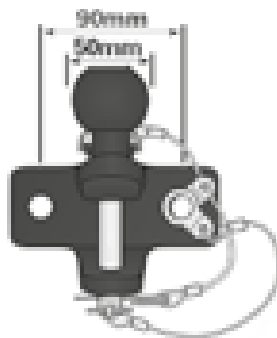

	Bulk Pack
	MP87
Replacement Pin & Chain	MP49484

Towing Jaw

TOWING JAW - BLACK

- Suitable for towing trailers fitted with a towing eye
- Can be used with a towing step fitted
- Approved to Reg 55
- D Value = 20Kn S Value = 350Kg
- Box quantity 5
- Pallet quantity 150

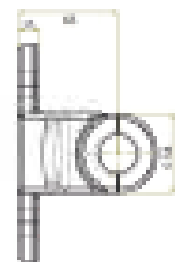
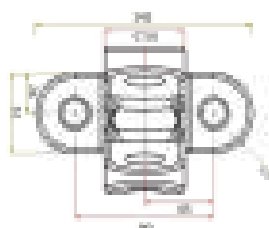

	Bulk Pack
	MP4862
Replacement Pin & Chain	MP4864

Ball & Pin Hitches

50MM AGRICULTURAL BALL PIN - SHORT SERIES

- Zinc plated, complete with nut and washer
- Threaded
- Not approved for highway use

L	W		Bulk Pack
70mm	19mm	Max load 500Kg	MP48119
70mm	22mm	Max load 1250Kg	MP48122
70mm	25.4mm	Max load 2000Kg	MP48125



50MM AGRICULTURAL BALL PIN - LONG SERIES

- Zinc plated with nut and washer, complete with safety chain and locking pins
- Threaded
- Suitable for agricultural use
- Not approved for highway use

L	W		Bulk Pack
190mm	22mm	Max load 1250Kg	MP44322
190mm	25mm	Max load 2000Kg	MP44325

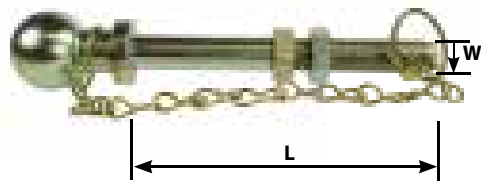

Ball & Pin Hitches

50MM COMBINED BALL AND PIN

- Black finish
- Non EU approved
- Max gross trailer weight 1500Kg
- D Value = 9.81Kn
- Agricultural and non-highway use only

Bulk Pack
MP481

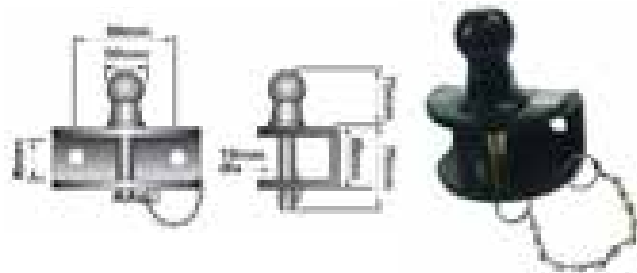

50MM HIGH REACH COMBINED BALL AND PIN

- Black finish
- Non EU approved
- Max gross trailer weight 3000Kg
- D Value = 14.7Kn
- Agricultural and non-highway use only

Bulk Pack
MP484



Agricultural Hitch Pins

HITCH PINS

- Zinc plated complete with linch pins
- Suitable for agricultural use
- Ideal for when a vehicle is fitted with a towing eye hook

Pin Diameter (W)	Working Length (L)	Bulk Pack
15.9mm	165mm	MP44341B
19mm	103mm	MP44342B
19mm	165mm	MP44343B
22mm	165mm	MP44344B
25mm	165mm	MP44345B
31.75mm	165mm	MP44346B

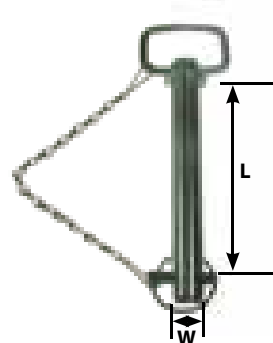

Towing Hardware

Towball Bolts

HIGH TENSILE (8.8) ZINC PLATED NUTS & BOLTS

- Made of high tensile 8.8 grade DIN931 steel
- Complete with shakeproof washers
- Fasteners are bright zinc plated

Thread Size x Length	Display Pack (Pack 2)
M16 x 45mm	MP249
M16 x 55mm	MP240
M16 x 65mm	MP248
M16 x 75mm	MP241
M16 x 90mm	MP250



TRADE PACK OF M16 BOLTS

- Made of high tensile 8.8 grade DIN931 steel

M16 Bolt Thread Size x Length (Bolts Only)	Pack Qty	Bulk Pack
M16 x 45mm	50	MP249TP
M16 x 55mm	50	MP240TP
M16 x 65mm	25	MP248TP
M16 x 75mm	25	MP241TP
M16 x 90mm	25	MP250TP



TRADE PACK OF M16 NUTS

- Pack qty 100

M16 Full Nuts (Nuts Only)	Bulk Pack
16mm nuts	MP285TP



TRADE PACK OF M16 SHAKEPROOF WASHERS

- Pack qty 100

16mm Shakeproof Washers (Washers Only)	Bulk Pack
16mm shakeproof washers	MP286TP



TOWBALL DROP PLATES

- Zinc plated
- Easy to fit and install on flange towbar



MP232



MP233

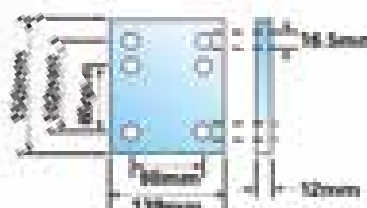

	Drop	Bulk Pack
4 hole drop plate	52mm (2")	MP230
4 hole drop plate	77mm (3")	MP231
4 hole drop plate	102mm (4")	MP232
6 hole drop plate	65-102mm (2.5"/4")	MP233

Towball Hardware

TOWBALL SPACER BLOCKS

- Made from aluminium



	Display Pack	Bulk Pack
12mm (0.5")	MP235	MP235B
25mm (1")	MP236	MP236B
38mm (1.5")	MP234	MP234B

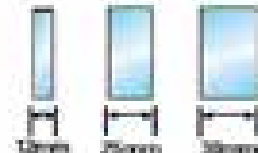
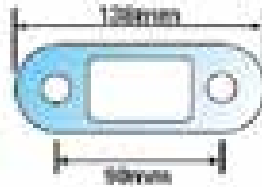

Towsteps

Maypole's open tread towsteps are suitable for vans, pickups and 4x4 vehicles fitted with a towbar.

- Protects vehicle trim and body work
- Provides safe and easy rear vehicle access
- Heavy duty steel construction
- Towbar mounted
- Accepts all standard towballs, towing jaws and ball and pin couplings

DOUBLE SIDED TOWSTEP - GOLD

- Complete with socket mounting plate and bolts
- L 71cm x W 16cm x H 5.5cm
- Fully zinc plated for corrosion resistance
- Display packed

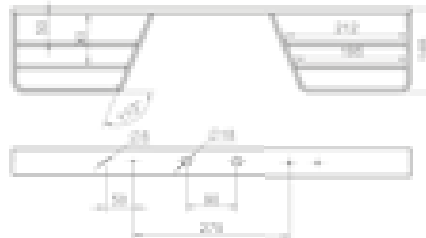

Display Pack	Pack Qty
MP346	4

HEAVY DUTY DOUBLE SIDED TOWSTEP - BLACK

- Heavy duty steel construction
- L 80cm x W 16.5cm x H 6cm
- Profiled treads provide extra grip
- Towball mounting space complies with Reg 55 requirements
- Corrosion resistant ED coating
- Box quantity 3

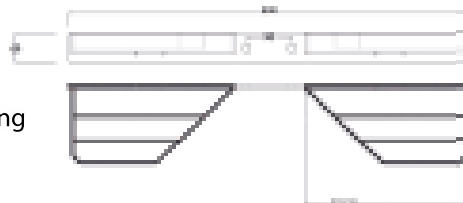

Bulk Pack	Pack Qty
MP3462	3

Bumper Protectors

Bumper Protectors

Protects bumpers from damage when coupling a trailer or caravan

BUMPER PROTECTOR IN BLACK

- Suitable for flange style towbars
- 2.0mm thick steel
- Corrosion resistant ED coating

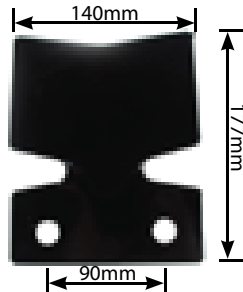

Display Pack	Bulk Pack
MP464	MP464B

SINGLE SOCKET IN BLACK

- Can be retro-fitted without disconnecting the socket wiring
- Ideal for 13 and 7 Pin



Display Pack	Bulk Pack
MP4432	MP4432B

BUMPER PROTECTOR IN BLACK

- Ideal for 7 Pin 12 N&S Type

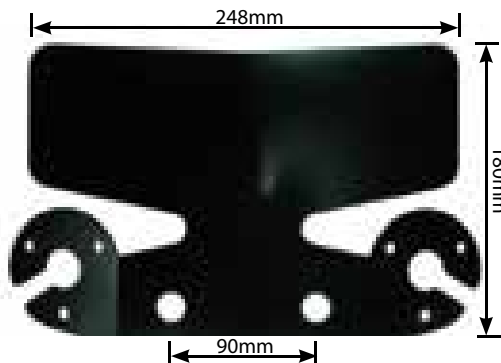

Display Pack	Bulk Pack
MP4431	MP4431B

BUMPER PROTECTOR IN STAINLESS STEEL

- Suitable for flange style towbars
- Stainless steel is strong and corrosion resistant

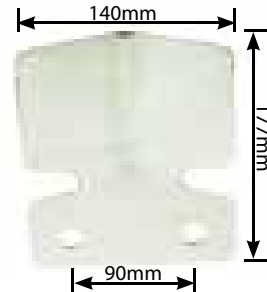

Display Pack	Bulk Pack
MP4645	MP4645B

SINGLE SOCKET IN STAINLESS STEEL

- Can be retro-fitted without disconnecting the socket wiring
- Ideal for 13 and 7 Pin
- Stainless steel is strong and corrosion resistant

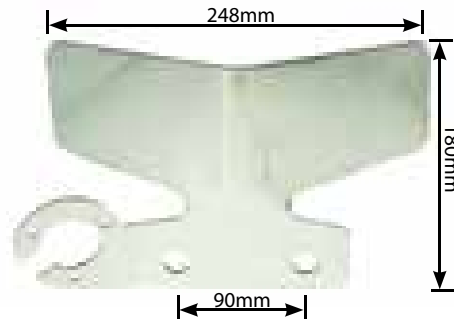

Display Pack	Bulk Pack
MP4437	MP4437B

BUMPER PROTECTOR IN STAINLESS STEEL

- Ideal for 7 Pin 12 N&S Type
- Stainless steel is strong and corrosion resistant

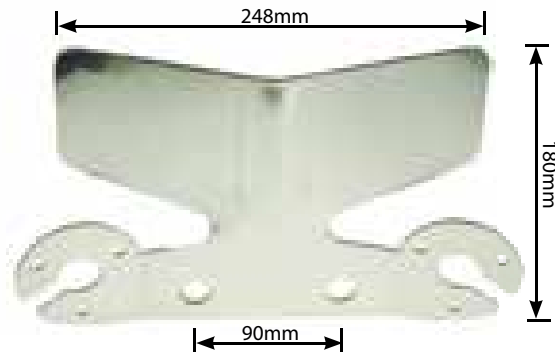

Display Pack	Bulk Pack
MP4435	MP4435B

Towball Covers

Towball Covers

BLACK PVC TOWBALL COVER

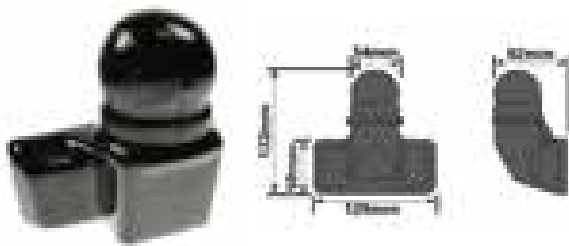

Display Pack	Bulk Pack (10 Only)
MP39	MP39B

BLACK PVC TOWBALL COVER WITH REFLECTOR

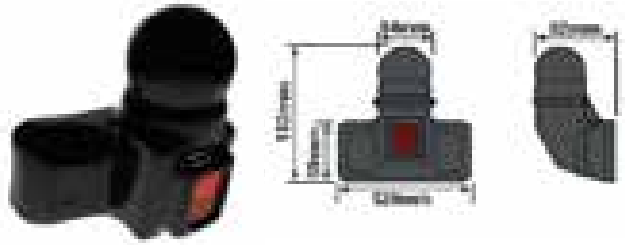

Display Pack	Bulk Pack (10 Only)
MP139	MP139B

LONG AND HIGH REACH BLACK PVC

■ Suitable for MP5005B ALKO style towballs

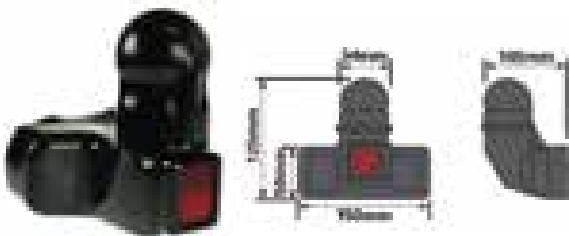

Display Pack	Bulk Pack (10 Only)
MP5009	MP5009B

PVC GOLF BALL STYLE TOWBALL COVER

■ To fit 50mm towball

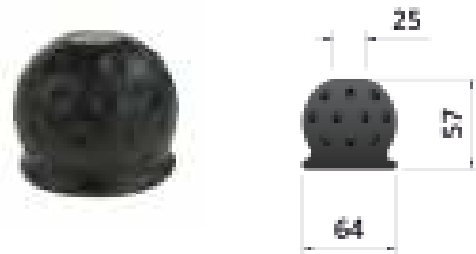

Display Pack	Bulk Pack (10 Only)
MP2445	MP2445B

TOWBALL COVER WITH RETENTION RING

■ Flexible rubber type

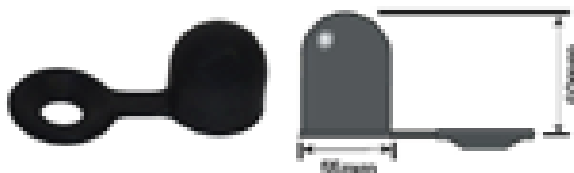

Display Pack	Bulk Pack
MP38	MP38B

ALUMINIUM TOWBALL COVER

■ To fit 50mm towball

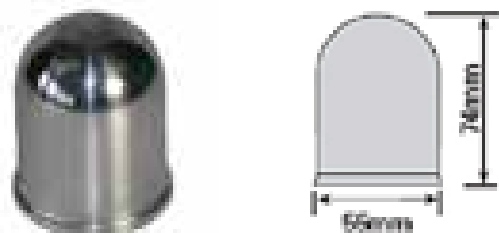

Display Pack	Bulk Pack
MP239	MP239B

CHROMED TOWBALL COVER

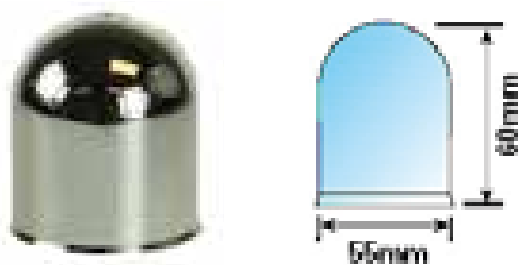

Display Pack	Bulk Pack (10 Only)
MP130	MP130B

BLACK PLASTIC TOWBALL COVER



Display Pack	Bulk Pack (50 Only)
MP244	MP244B

You manufacture the trailer, we will light it

Maypole Ltd has a long history of providing trailer lighting solutions, ranging from bespoke trailer board production, extensive lamp ranges from major manufacturers to a large and expanding range of LED lamp options.

We also manufacture harness solutions in-house. Connectivity options include Radex, AJBA, Aspöck, Deutsch and SuperSeal.

Benefits of choosing Maypole

- Manufactured in Birmingham UK
- Bespoke or standard options
- Lamp approval documentation available
- Widest range of harness options
- Competitive pricing
- Widest selection of LED & bulb lamps
- Quality European branded lamp options
- Design and after sales support
- Type Approval advice and support
- Drawings and schematics supplied to aid your Type Approval process
- IP67 rated connectors
- Multiple cable options

Maypole's In-house Services

- Dedicated production area
- Technical Sales Support. We will visit and work with you for a solution that meets your needs
- Automatic crimpers installed
- Computerised cable cutter
- We also assemble towing electrics and extension leads
- Stock holding on regular orders, keeping your production running
- MOQ often as low as 10

Trailer Lighting Solutions Made Easy



Manufactured at



Contact our technical or sales team on tel: +44 (0)121 270 4301 or email: sales@maypoleltd.co.uk

Maypole supply trailer lighting solutions to many of the UK's leading trailer builders in many market sectors. Here are few of the applications we supply lighting

harnesses to. If you think we could help you with your trailer requirements, contact our sales team on 0121 270 4301.

Agricultural - Robust with harness protection for 'farm' environment



Catering - Harness with power take offs



Shredder - Compact and professional

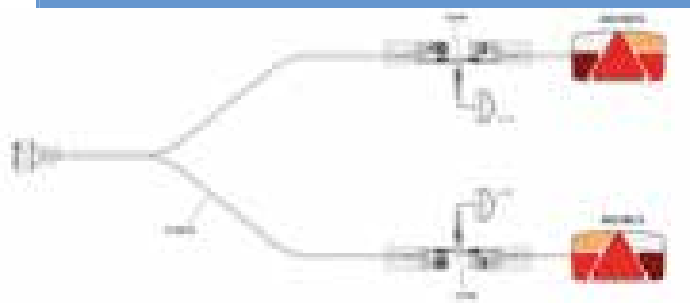

Flat Bed - Featuring MP8605 LED full function lamps



Trailer Lighting Applications

Boat Trailer - Harness system with removable trailer board to allow boat launch

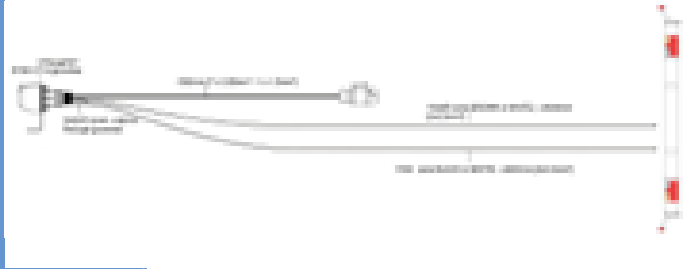

Welfare Unit - Harness system with removable trailer board to stop vandalism

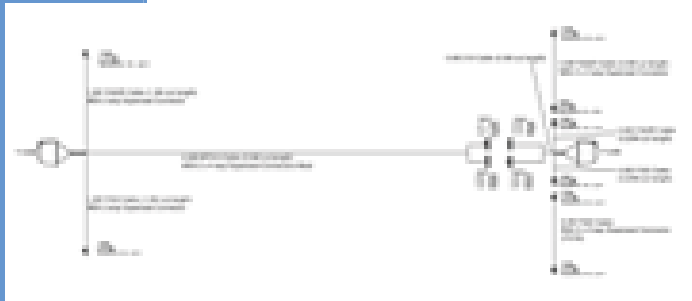

Cable Drum Trailer - Bespoke harness for unique trailer shape

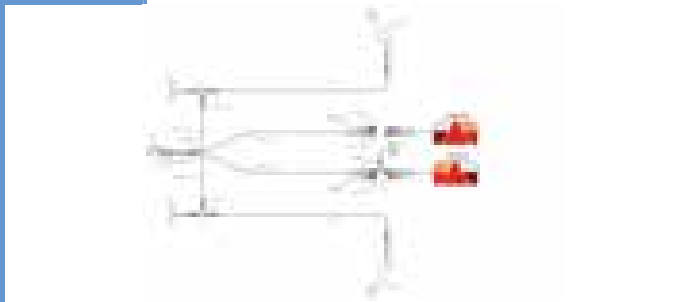

Car Transporter - Multi-link harness to run multiple lamps

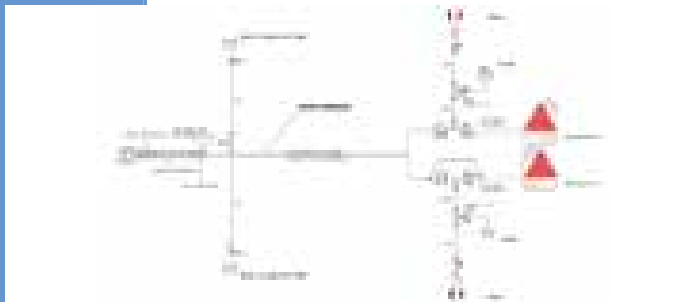

Maypole offers two types of 'click and play' connection systems, both offering flexible and easy to fit solutions for any trailer application.

SuperSeal Connector System
SuperSeal connectors are a common choice among lamp and vehicle manufacturers. This system provides waterproof quick connections. Other benefits include;

- Sturdy and reliable contacts

- Double contact spring for high contact force
- Silicon rubber shaped seals
- IP67 rating
- Standard or bespoke options
- Allows for quick rectification of lamps if damaged. No tooling needed
- Heat shrink applied for extra protection and professional finish
- Cost effective

Example of a SuperSeal Connector System on a Flat Bed Trailer

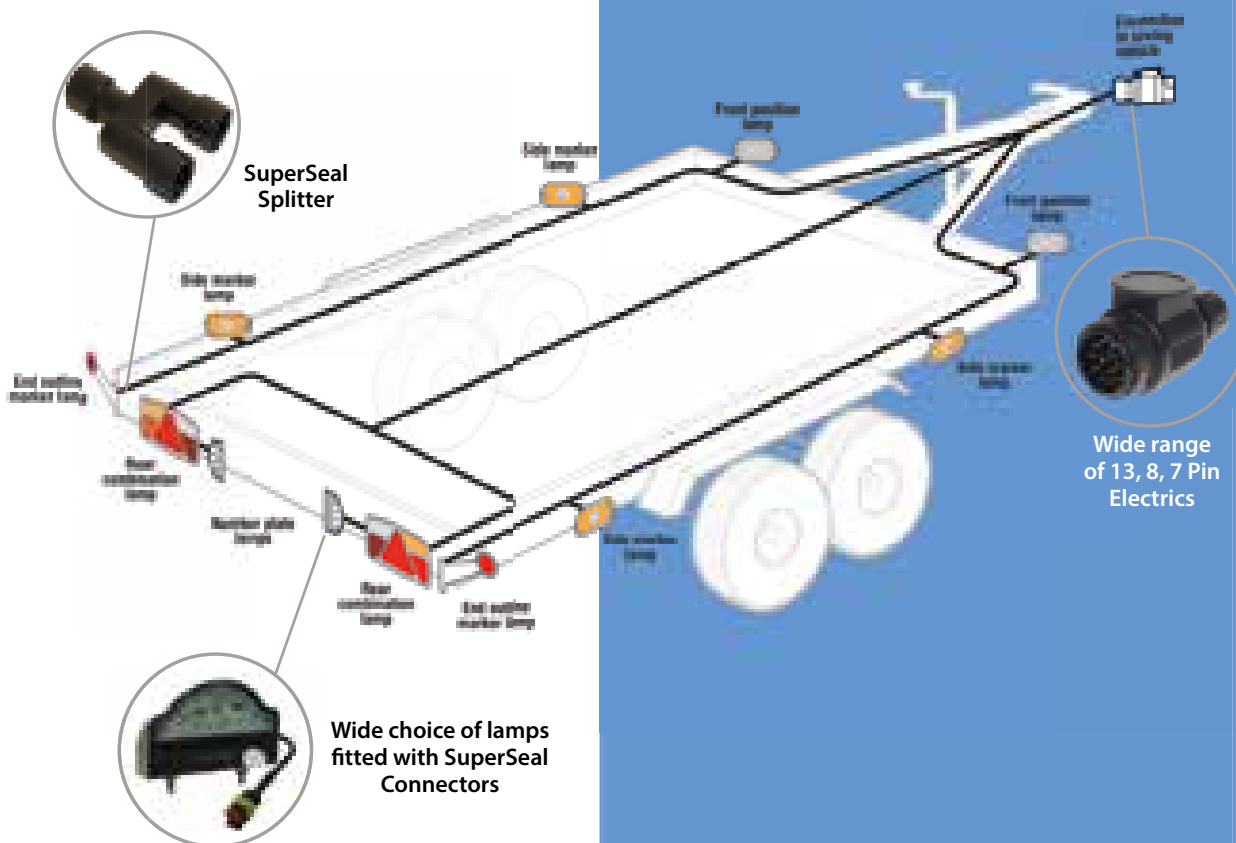

Heat Shrink

- Heat shrink or fit 'Boot' covers



Connectors

- Y piece connector unique to Maypole
- Click and connect for multiple lamp applications



Lamps

- Any LED lamp you need can be fitted, the choice is yours.

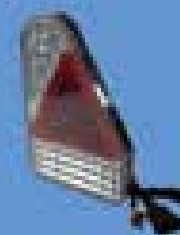

Double-Click Connector System

Working alongside a SuperSeal connector system, we offer a flat twin cable that connects front, rear, side and outline marker lamps using waterproof double click cable connectors. The system can also be used to power number plate lamps. Other benefits include;

- Already common in the market place

Example of a Hybrid Double-Click & SuperSeal Connector System on a Welfare Unit

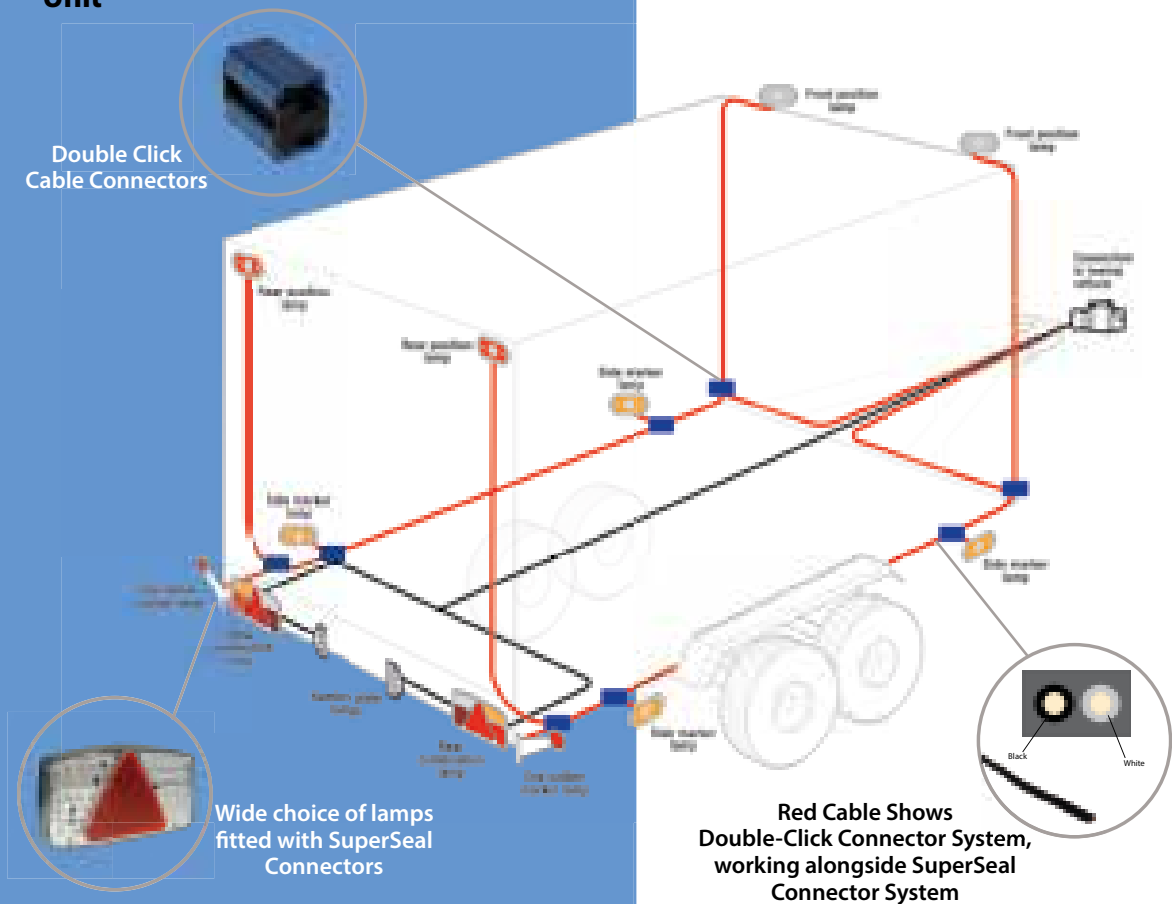

- Connects anywhere on the cable to power up marker lamps
- No electrical knowledge required, simple and easy to fit
- IP68 rating
- Incredibly flexible and allows additional lamps to be added
- Compatible with the Aspöck equivalent system
- Full technical support

Heat Shrink End Caps



Double-Click Connector

- Easy to fit
- Compatible with Aspöck flat 2x0.75mm² cable



LED Marker Lamps

- Supplied with cable and waterproof end cap



Radex Options



Range of harness spares and fittings for Radex lamps

The quick fit system is fitted with rear mounted sockets for quick and easy connection to the seven core cable and plug. Sockets are also provided for plug-in power take off cables to side and front marker lamps.

- Traditional and established range
- 5 Pin, 9 Pin or hard wired options
- Harness manufactured at Maypole using genuine Radex components

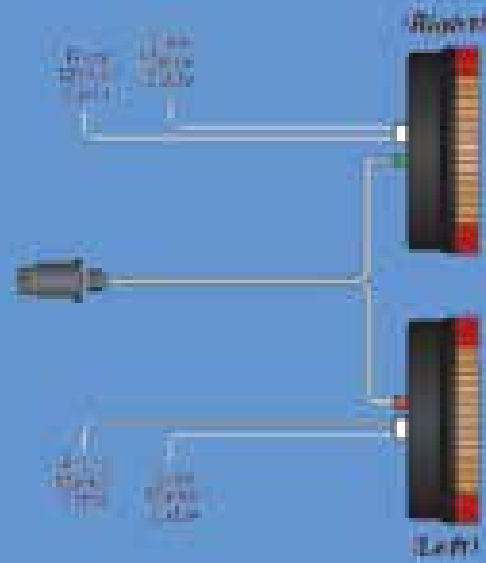

Trailer Lighting Options

13 Pin Harness

MP753PG

- Green Plug Kit (6 Pin)



MP753PR

- Red Plug Kit (6 Pin)



MP804PW

- White Plug Kit



MP7531

- Spare Pins (6 Pin)



7 Pin Harness

MP804PG

- Green Plug Kit (5 Pin)



MP804PR

- Red Plug Kit (5 Pin)

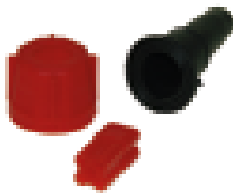

MP804PW

- White Plug Kit



MP8041

- Spare Pins (5 & 2 Pin marker system)



For more details please see Radex lamp options on page 55

AJBA Options



Range of AJ.BA harness spares

AJBA harnesses are manufactured in-house using genuine AJBA components

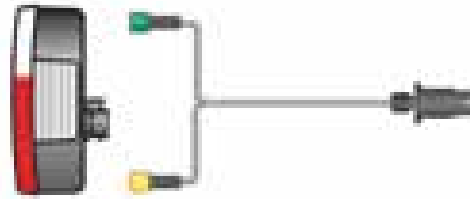

13 Pin Harness

MP748PY

- 6 Pin Yellow Connector



MP748PG

- 6 Pin Green Connector



7 Pin Harness

MP8306B

- 5 Pin Yellow Plug



MP8307B

- 5 Pin Green Plug



For more details please see AJ.BA lamp options on page 61

Deutsch DT Series

Maypole also offer Deutsch DT series connectors for special harness builds. An environmentally sealed connector specifically for cable to cable applications. Designed to operate in a range of environmental

conditions without degradation in performance. The DT connector has proven reliability and performance at a competitive price.



The main harness can now be manufactured by Maypole to your requirements. Please

enquire if you have alternate requirements.

Trailer Lighting Options

Trailer Harness Solutions

Extension and Link Harnesses

A wide range of plug to socket and plug to plug leads. These are used to power number plates and marker lamps. By utilising a 'Y' piece connector, you can click and easily connect up the trailer or higher up, like on a box trailer.

EXTENSION HARNESS

- Features a 2 way SuperSeal plug and 2 way socket
- Made with twin core cable for running markers and number plate lamps

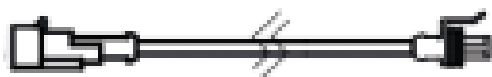

Cable Length	Code
1m	MP75601
2m	MP75602
3m	MP75603



LINK HARNESS

- Features a 2 way SuperSeal plug at each end
- Allows easy connection to lamps with a SuperSeal outlet



Cable Length	Code
1m	MP75701
2m	MP75702
3m	MP75703



'Y' PIECE CONNECTOR

- Suitable for SuperSeal 2 way plugs
- Allows quick and easy wiring for additional marker and number plate lamps
- Unique to Maypole. Manufactured from our design and with our own tooling
- Available in 10s only

Code
MP7524B



SUPERSEAL CONNECTORS

- Ideal for rectification work



2 Way SuperSeal Kit	Code	Kit Contents
Male	MP7002	10 x 2 way male housing, 20 x grommets & 20 x female terminal pins
Female	MP8002	10 x 2 way female housing, 20 x grommets & 20 x male terminal pins

Trailer Harness Solutions

SuperSeal Lamps

We supply a wide range of LED and bulb lamps with SuperSeal Connectors. Below is our recommended range of lamps, but please ask our technical team about other lamps in our range that could have the SuperSeal connector added.

RECOMMENDED LAMPS

Code	Description
MP7473BSS	Clear Front Marker & Reflector with SuperSeal 1x2 Way Socket
MP8171BSP	12/24v Amber LED Side Marker with SuperSeal 1x2 Way Plug
MP8172BSP	12/24v Clear LED Front Marker with SuperSeal 1x2 Way Plug
MP8575BSP	10-30v Amber LED Side Marker & Reflex with SuperSeal 1x2 Way Plug
MP8576BSS	10-30v LED Clear Front Marker & Reflector with SuperSeal 1x2 Way Socket
MP7726BS	10-30v LED Straight Red/White/Amber Rubber Stalk Marker with SuperSeal 1x2 Way Plug
MP8702BS	10-30v LED Red/White Outline Marker With Reflector with SuperSeal 1x2 Way Socket
MP8702BSP	10-30v LED Red/White Outline Marker With Reflector with SuperSeal 1x2 Way Plug
MP8761BSS	12/24v Red/White Low Outline Marker with SuperSeal 1x2 Way Socket
MP8603BLS	L/H LED 10-30v 7 Function Combination Lamp with SuperSeal 1x4 Way Socket & 1x2 Way Plug
MP8603BRS	R/H LED 10-30v 7 Function Combination Lamp with SuperSeal 1x4 Way Socket & 1x2 Way Plug
MP8605BLS	L/H LED 10-30v 7 Function Combination Lamp with SuperSeal 1x4 Way Socket, 1x2 Way Socket & 1x2 Way Plug
MP8605BRS	R/H LED 10-30v 7 Function Combination Lamp with SuperSeal 1x4 Way Socket, 1x2 Way Socket & 1x2 Way Plug
MP9634BSS	Rear LED Fog Light with SuperSeal 1x2 Way Socket
MP8227BSP	LED 10-30v Number Plate with SuperSeal 1x2 Way Plug

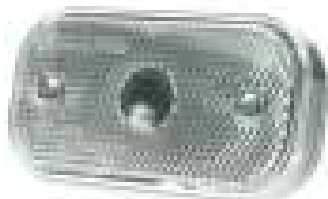

MP7473BSS



MP8171BSP



MP8172BSP



MP7726BS



MP8702BSP



MP8603BLS



MP8605BLS



MP9634BSS



MP8227BSP

Trailer Harness Solutions

Aspöck Compatible Lighting Harnesses

5PIN 4M LIGHTING HARNESS

- 12N vehicle connection
- 5 pin Aspöck compatible plugs to supply left & right combination lamps
- 4m overall length

Bulk Pack
MP72604



5PIN 5M LIGHTING HARNESS

- 13 Pin vehicle connection
- 5 pin Aspöck compatible plugs to supply left & right combination lamps
- 5m overall length

Bulk Pack
MP72905



5 / 8 PIN LIGHTING HARNESSES

- MP72405 has a 12N vehicle connection. MP72706, MP72708 & MP72808 has 13 Pin connection
- 5 pin Aspöck compatible plugs to supply left & right combination lamps
- MP72808 has 8 pin Aspöck compatible plugs
- 0.75mm square DC cable is fed from the rear of the harness to both the left and right hand lamp connections to the quick-connect range of Aspöck marker lamps.



MP72706



MP72708



MP72808

Overall Length	DC Cable Length	Bulk Pack
6m	4.5m	MP72706
8m	6m	MP72708
8m	6m	MP72808

Trailer Harness Solutions

Double-Click Connector Accessories

100M BLACK RECTANGLE CABLE 2 X 0.75MM²

- 2 x 0.75mm² flat cable
- Compatible with Aspöck harness range
- Suitable for use with MP3216B double-click cable connectors
- Use MP3219B heat shrink end caps to seal cable ends
- Available in 100m drum

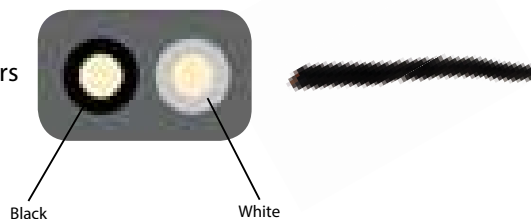

Bulk Pack
MP321

HEAT SHRINK END CAPS FOR MP321 CABLE

- Easy to fit
- Creates a waterproof cable seal



Trade Pack	Bulk Pack (100s Only)
MP3219 (Per 20)	MP3219B

DOUBLE-CLICK CABLE CONNECTOR

- Waterproof
- Easy to fit, no electrical training required
- Compatible with Aspöck flat 2 x 0.75mm² cable
- Suitable for use with MP321 cable



Trade Pack	Bulk Pack (10s Only)
MP3216 (PER 10)	MP3216B

Trailer Retrofit Kits

LED lighting harness kits to retrofit older trailers.

LED CONVERSION KIT - SUITABLE FOR 8' X 6' (O1) TRAILERS

- Kit includes;
- MP75106 6m harness with 7 pin plug
- 2 x 12V LED square combination lamps
- 12V LED fog lamp
- Set of triangle reflectors
- Set of clear and amber self-adhesive reflectors



Bulk Pack
MP77406

LED CONVERSION KITS - SUITABLE FOR UP TO 16' TRAILERS

- Kit includes;
- MP75506 8m harness with 13 pin plug
- Choice of 2 x 12/24V LED 6 function combination lamps
- 2 x 12V LED number plate lamps
- 2 x clear front self-adhesive reflectors
- 4 x amber side self-adhesive reflectors



Lamps	Bulk Pack
Kit with MP8603BL/BR	MP77408
Kit with MP8605BL/BR	MP77407

MP77408

Radex 13 Pin Harness and Lighting Systems

Twin Fog and Reverse

RADEX 5+4 OR 6+4 WITH QUICK FIT POWER OUTLET CONNECTOR

- 4 Pin quick fit harness for running up to two marker lamps from a single rear combination lamp
- Manufactured at Maypole using genuine Radex components
- Wide range of lamp options
- For marker lamps with spade terminal connection



Lamps not included

Cable Length	Code
2 x 4m	MP80404

MAIN HARNESS - 13 PIN PLUG / 6 PIN CONNECTORS

- Main 13 Pin (8 Pin Plug) harness
- Manufactured at Maypole using genuine Radex components
- Radex 6 Pin lamp quick connectors
- Suitable for all Radex 6+4 Pin quick fit connector lamps



Cable Length	Code
6m	MP76706

RADEX VERTICAL COMBINATION LAMPS (6 PIN) - (6900)

- Modern chrome effect design
- Ready to fit
- Vertical orientation
- Full 7 function lamps giving twin fog and twin reverse functionality
- Power take off for remote number plate and/or marker lamps
- Bulbs included

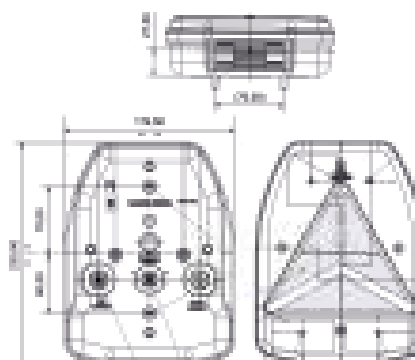

Bulk Pack	Stop	Tail	Indicator	Reflector	No. Plate	Reverse	Fog	Voltage	Connection	Mount
MP7690BL	✓	✓	✓	✓		✓	✓	12V	6+4 Pin	Studs
MP7690BR	✓	✓	✓	✓		✓	✓	12V	6+4 Pin	Studs
MP7691B	Spare Lens for MP7690BL/BR									

Radex 13 Pin Harness and Lighting Systems

Right Hand Fog and Left Hand Reverse

MAIN HARNESS - 13 PIN PLUG / 5 PIN CONNECTORS

- 13 Pin plug
- Manufactured at Maypole using genuine Radex components
- 2 x 5 Pin Radex quick fit lamp connectors
- Wide range of lamp options
- Suitable for all Radex 5+4 quick fit connector lamps



Cable Length	Code
6m	MP76806

RADEX VERTICAL COMBINATION LAMP 5+4 PIN QUICK FIT SYSTEM

- Ready to fit
- Bulbs included

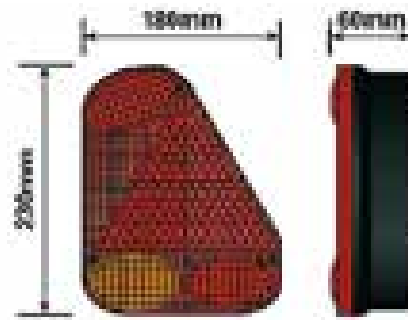

Bulk Pack	Stop	Tail	Indicator	Reflector	No. Plate	Reverse	Fog	Voltage	Connection	Mount
MP7709BR	✓	✓	✓	✓			✓	12V	5+4 Pin	Studs
MP77019BL	✓	✓	✓	✓		✓		12V	5+4 Pin	Studs
MP771BR	Spare Lens for MP7709BR									
MP7710BL	Spare Lens for MP77019BL									

Twin Fog

MARKER HARNESS - 7 PIN PLUG / 5 PIN CONNECTORS

- 7 Pin plug
- 2 x 5 Pin Radex lamp connectors
- Suitable for use with all Radex 5+4 Pin quick fit connector lamps

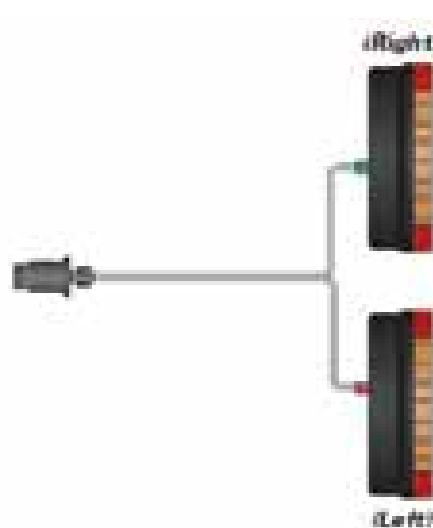

Cable Length	Code
4m	MP80304
6m	MP80306
8m	MP80308

Lamps not included

Radex 7 Pin Harness and Lighting Systems

RADEX 5+4 OR 6+4 WITH QUICK FIT POWER OUTLET CONNECTOR



- 4 Pin quick fit harness for running up to two marker lamps from a single rear combination lamp
- Manufactured at Maypole using genuine Radex components
- Wide range of lamp options
- For marker lamps with spade terminal connection



Lamps not included

Cable Length	Code
2 x 4m	MP80404

RADEX HORIZONTAL COMBINATION LAMPS 5 PIN QUICK FIT SYSTEM - (2800)



- Features internal anti-vibration plate to prevent bulbs shaking loose
- Marker lamp facilities
- Bulbs included



Bulk Pack	Stop	Tail	Indicator	Reflector	No. Plate	Reverse	Fog	Voltage	Connection	Mount
MP7509BL	✓	✓	✓	✓	✓		✓	12V	5+4 Pin	Studs
MP7509BR	✓	✓	✓	✓	✓		✓	12V	5+4 Pin	Studs
MP751BL	Spare Lens for MP7509BL									
MP751BR	Spare Lens for MP7509BR									

RADEX VERTICAL COMBINATION LAMPS 5 PIN QUICK FIT SYSTEM - (2900)



- Bulbs included
- 5+4 Pin marker lamp facility
- 5 Pin no marker lamp facility



Bulk Pack	Stop	Tail	Indicator	Reflector	No. Plate	Reverse	Fog	Voltage	Connection	Mount
MP7709BL	✓	✓	✓	✓			✓	12V	5+4 Pin	Studs
MP7709BR	✓	✓	✓	✓			✓	12V	5+4 Pin	Studs
MP771BL	Spare Lens for MP7709BL									
MP771BR	Spare Lens for MP7709BR									

Radex 7 Pin Harness and Lighting Systems

RADEX HORIZONTAL COMBINATION LAMPS 5 PIN QUICK FIT SYSTEM - (5900)



- Bulbs included
- 5+4 Pin marker lamp facility

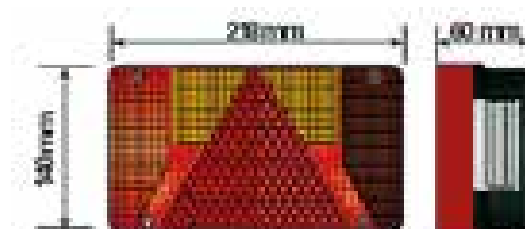

Bulk Pack	Stop	Tail	Indicator	Reflector	No. Plate	Reverse	Fog	Voltage	Connection	Mount
MP801BL	✓	✓	✓	✓	✓		✓	12V	5+4 Pin	Studs
MP801BR	✓	✓	✓	✓	✓		✓	12V	5+4 Pin	Studs
MP802BL	Spare Lens for MP801BL									
MP802BR	Spare Lens for MP801BR									

RADEX HORIZONTAL COMBINATION LAMPS 5 PIN QUICK FIT SYSTEM - (6800)



- Bulbs included
- 5+4 Pin marker lamp facility (not MP8055BL/BR)

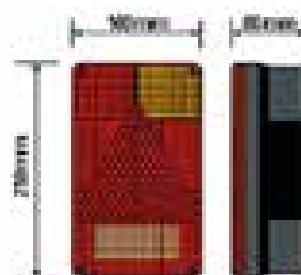
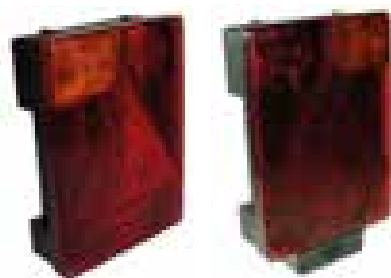

Bulk Pack	Stop	Tail	Indicator	Reflector	No. Plate	Reverse	Fog	Voltage	Connection	Mount
MP8059BL	✓	✓	✓	✓			✓	12V	5+4 Pin	Studs
MP8059BR	✓	✓	✓	✓			✓	12V	5+4 Pin	Studs
MP8059BRN	✓	✓	✓	✓	✓		✓	12V	5+4 Pin	Studs
MP8055BL	✓	✓	✓	✓			✓	12V	5 Pin	Studs
MP8055BR	✓	✓	✓	✓			✓	12V	5 Pin	Studs
MP806BL	Spare Lens for MP8059BL/8055BL									
MP806BR	Spare Lens for MP8059BR/8059BRN/8055BL									

Radex 13 Pin Water Dive Waterproof Lamps

Twin Fog and Reverse

RADEX WATER DIVE COMBINATION LAMP (2800)

- IP68 rated
- Waterproof and dustproof
- Includes waterproof connectors
- 12 or 24v capacity
- Ideal for boat trailers

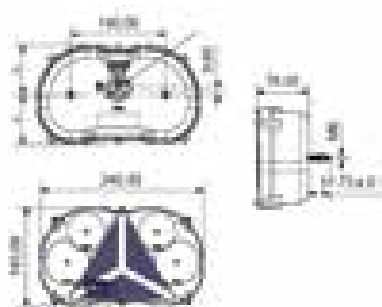

Bulk Pack	Stop	Tail	Indicator	Reflector	No. Plate	Reverse	Fog	Voltage	Connection	Mount
MP7586BL	✓	✓	✓	✓		✓	✓	12V or 24V	Radex water dive	Studs
MP7586BR	✓	✓	✓	✓		✓	✓	12V or 24V	IP68 quick connector	Studs

Radex Spares

5 PIN CONNECTORS

- Contents include centre, outer and gasket (1 each)
- Pack of 10

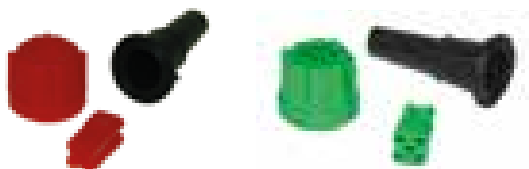

Code	
MP804PR	Red Plug Kit
MP804PG	Green Plug Kit

SPARE PINS

- Spare pins for quick fit plug
- MP8041 is in 50s only
- MP7531 is in 200s only

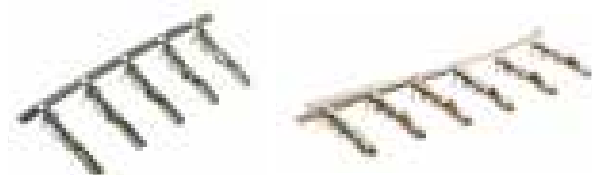

Code (Each)	
MP8041	Suitable for 5 Pin & 2 Pin marker system
MP7531	Suitable for 6 Pin system

6 PIN CONNECTORS

- Contents include centre, outer and gasket (1 each)
- Pack of 10



Code	
MP753PR	Red Plug Kit
MP753PG	Green Plug Kit

SIDE MARKER CONNECTORS

- Contents include 2 x centre, outer and double gasket
- Pack of 10



Code	
MP804PW	White Plug Kit

Harnesses

Radex Harnesses Matrix Guide

HARNESSES TO SUIT RADEX LAMPS



■ Use the table below to match a Radex lamp with the correct harness

		MP7690BL/BR	MP7709BL	MP7709BR	MP77019BL	MP7509BL	MP7509BR	MP801BL/BR	MP8059BL/BRN	MP8055BL/BR	MP7586BL/BR
MAIN HARNESS - 7 PIN TWIN FOG											
MP80304	7 PIN 4M HARNESS L/H + R/H FOG		✓	✓		✓	✓	✓	✓	✓	✓
MP80306	7 PIN 6M HARNESS L/H + R/H FOG		✓	✓		✓	✓	✓	✓	✓	✓
MP80308	7 PIN 8M HARNESS L/H + R/H FOG		✓	✓		✓	✓	✓	✓	✓	✓
MAIN HARNESS - L/H REV + R/H FOG											
MP76806	13 PIN 6M HARNESS L/H REV + R/H FOG			✓	✓		✓				
MAIN HARNESS - TWIN FOG + REV											
MP76706	13 PIN 6M HARNESS TWIN FOG + REV	✓									
SIDE MARKER AND NUMBER PLATE ACCESSORIES											
MP80404	4M POWER TAKE OFF HARNESS	✓	✓	✓	✓	✓	✓	✓	✓		



MP80304



MP76806



MP76706



MP80404

AJBA 13 Pin Harness and Lighting Systems

Twin Fog and Reverse

MARKER HARNESS - 13 PIN PLUG / 2 X 6 PIN CONNECTORS

- 13 Pin plug
- 2 x 6 Pin AJBA lamp connectors
- Manufactured at Maypole using genuine AJBA connectors

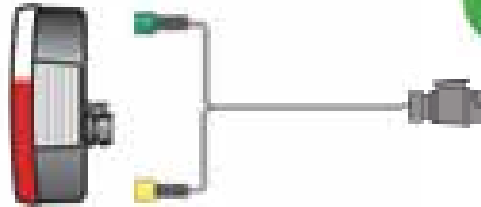

Cable Length	Code
6m	MP74806
8m	MP74808

AJ.BA HORIZONTAL COMB. LAMP 6 PIN CONNECTORS (FP.48)

- Full 7 functions
- Short body version

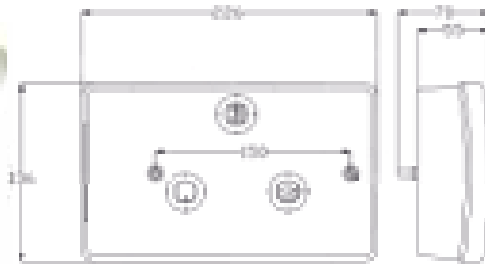
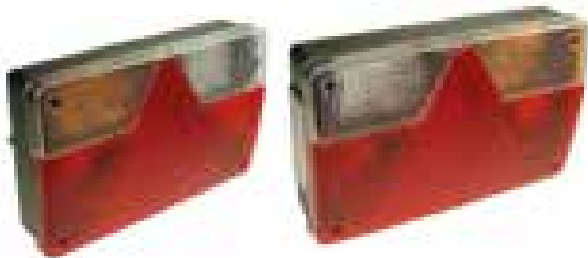

Bulk Pack	Stop	Tail	Indicator	Reflector	No. Plate	Reverse	Fog	Voltage	Connection	Mount
MP8304BL	✓	✓	✓	✓	✓	✓	✓	12V	6 Pin	Studs
MP8304BR	✓	✓	✓	✓	✓	✓	✓	12V	6 Pin	Studs
MP83035BL	Spare Lens for MP8304BL									
MP83035BR	Spare Lens for MP8304BR									

AJ.BA HORIZONTAL COMB. LAMP 6 PIN CONNECTORS (FP.88)

- Full 7 functions
- Long body version

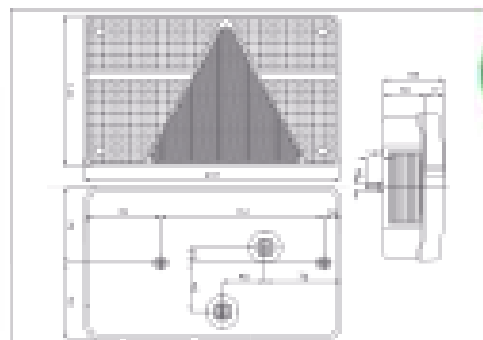
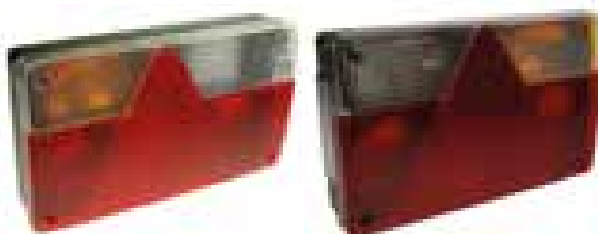

Bulk Pack	Stop	Tail	Indicator	Reflector	No. Plate	Reverse	Fog	Voltage	Connection	Mount
MP7491BL	✓	✓	✓	✓	✓	✓	✓	12V	6 Pin	Studs
MP7491BR	✓	✓	✓	✓	✓	✓	✓	12V	6 Pin	Studs
MP7497BL	Spare Lens for MP7491BL									
MP7497BR	Spare Lens for MP7491BR									

AJBA 13 Pin Harness and Lighting Systems

Right Hand Fog and Left Hand Reverse Systems

MAIN HARNESS



- 13 Pin plug
- 2 x 5 Pin connectors
- Manufactured at Maypole using genuine AJBA connectors



Cable Length	Code
6m	MP89406

AJ.BA HORIZONTAL COMBINATION LAMP 5 PIN CONNECTOR (RL.96)



- Bulbs included



Bulk Pack	Stop	Tail	Indicator	Reflector	No. Plate	Reverse	Fog	Voltage	Connection	Mount
MP8943BL	✓	✓	✓	✓	✓	✓		12V	5 Pin	Studs
MP8943BR	✓	✓	✓	✓	✓		✓	12V	5 Pin	Studs
MP8948B	Spare Lens for MP8943BL									
MP8949B	Spare Lens for MP8943BR									

Twin / Single Fog

MAIN HARNESS - 7 PIN PLUG / 2 X 5 PIN CONNECTORS



- 7 Pin plug
- 2 x 5 Pin connectors
- Manufactured at Maypole using genuine AJBA connectors



Cable Length	Code
4m	MP83104
6m	MP83106

AJBA 7 Pin Harness and Lighting Systems

AJ.BA HORIZONTAL COMB. LAMP 5 PIN CONNECTOR (RL.96)



■ Bulbs included

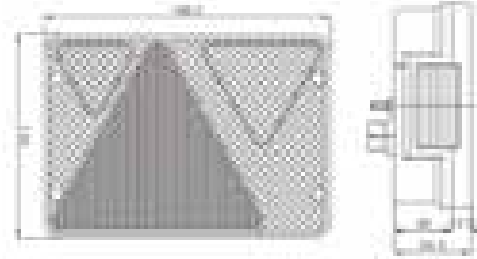

Bulk Pack	Stop	Tail	Indicator	Reflector	No. Plate	Reverse	Fog	Voltage	Connection	Mount
MP8943BR	✓	✓	✓	✓	✓		✓	12V	5 Pin	Studs
MP89430BL	✓	✓	✓	✓	✓		✓	12V	5 Pin	Studs
MP8942BL	✓	✓	✓	✓	✓			12V	5 Pin	Studs
MP8947B	Spare Lens for MP8942BL & MP89430BL									
MP8949B	Spare Lens for MP8943BR									

AJ.BA 240MM (LONG) HORIZONTAL COMBINATION 4/5 PIN CONNECTOR (FP.96)



■ Bulbs included

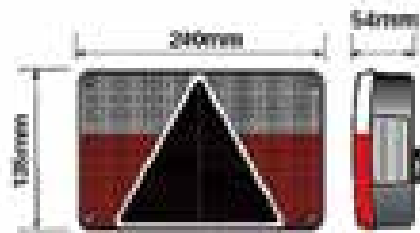

Bulk Pack	Stop	Tail	Indicator	Reflector	No. Plate	Reverse	Fog	Voltage	Connection	Mount
MP831BL	✓	✓	✓	✓	✓			12V	4 Pin	Studs
MP831BR	✓	✓	✓	✓	✓		✓	12V	5 Pin	Studs
MP8315BL	Spare Lens for MP831BL									
MP8315BR	Spare Lens for MP831BR									

AJ.BA 220MM (SHORT) HORIZONTAL COMBINATION 5 PIN CONNECTOR (FP.56)



■ Bulbs included

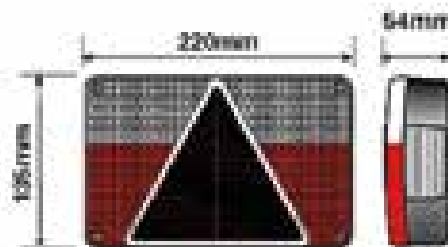

Bulk Pack	Stop	Tail	Indicator	Reflector	No. Plate	Reverse	Fog	Voltage	Connection	Mount
MP830BL	✓	✓	✓	✓	✓			12V	5 Pin	Studs
MP830BR	✓	✓	✓	✓	✓		✓	12V	5 Pin	Studs
MP8305B	Spare Lens for MP8943BL									

Harnesses

AJ.BA Spares

5 PIN CONNECTORS



- Inner, outer and gasket (1 each)
- Pack of 10



Code	
MP8307B	Green Plug
MP8306B	Yellow Plug

6 PIN CONNECTORS



- Centre, outer and gasket (1 each)
- Pack of 10



Code	
MP748PG	Green Plug
MP748PY	Yellow Plug

AJ.BA Harnesses Matrix Guide

HARNESSES TO SUIT AJ.BA LAMPS



- Use the table below to match a AJ.BA lamp with the correct harness

	MP8304BL/BR	MP7491BL/BR	MP8943BL	MP8943BR	MP89430BL	MP8942BL	MP831BL/BR	MP830BL/BR
--	-------------	-------------	----------	----------	-----------	----------	------------	------------

MAIN HARNESS - TWIN FOG

MP83104	7 PIN 4M HARNESS R/H FOG				✓	✓	✓	✓
MP83106	7 PIN 6M HARNESS R/H FOG				✓	✓	✓	✓
MP83108	7 PIN 8M HARNESS R/H FOG				✓	✓	✓	✓

MAIN HARNESS - L/H REV + R/H FOG

MP89406	13 PIN 6M HARNESS L/H REV + R/H FOG			✓	✓			
---------	-------------------------------------	--	--	---	---	--	--	--

MAIN HARNESS - TWIN FOG / TWIN REVERSE

MP74806	13 PIN 6M HARNESS L/H REV + R/H FOG	✓	✓					
MP74808	13 PIN 8M HARNESS L/H REV + R/H FOG	✓	✓					



MP83106



MP74806



MP89406

LED Marker Lamps

LED Marker Lamps

LED MARKER LAMP - INTEGRAL REFLECTOR

- Manufactured in Europe
- Compact design
- IP66
- MP8576BQ, MP8575BQ & MP8577BQ are pre-wired for use with the Aspöck quick connect system. They are also supplied with 1m 2 x 0.75mm² rectangular cable and waterproof end cap.

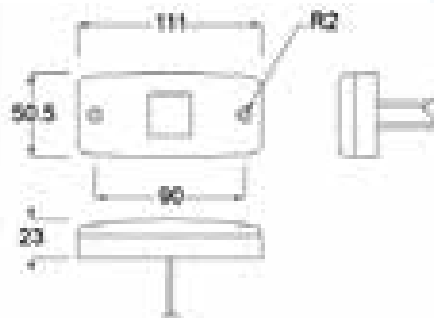

Display Pack	Bulk Pack	Position	Voltage	Connection	Orientation	Reflector	Mount
MP8576	MP8576B	Front Clear	10/30v	21cm cable	Horizontal	✓	Holes
MP8575	MP8575B	Side Amber	10/30v	21cm cable	Horizontal	✓	Holes
MP8577	MP8577B	Rear Red	10/30v	21cm cable	Horizontal	✓	Holes
-	MP8576BQ	Front Clear	10/30v	1m of square cable	Horizontal	✓	Holes
-	MP8575BQ	Side Amber	10/30v		Horizontal	✓	Holes
-	MP8577BQ	Rear Red	10/30v		Horizontal	✓	Holes

LED MARKER LAMP - SUPERSEAL SOCKET (RM50)

- Commonly used on commercial vehicles
- Integral 2 Pin SuperSeal socket for quick connection
- Clip base
- MP8164B - Horizontal pendant bracket
- IP67

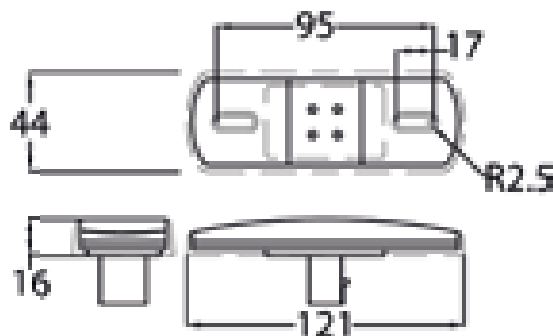

Display Pack	Bulk Pack	Position	Voltage	Connection	Orientation	Reflector	Mount
-	MP8162B	Front Clear	12/24v	Superseal	Horizontal	✓	Holes
-	MP8161B	Side Amber	12/24v	Superseal	Horizontal	✓	Holes

LED Marker Lamps

LED MARKER LAMP - SUPERSEAL SOCKET

- Slimline design
- IP67

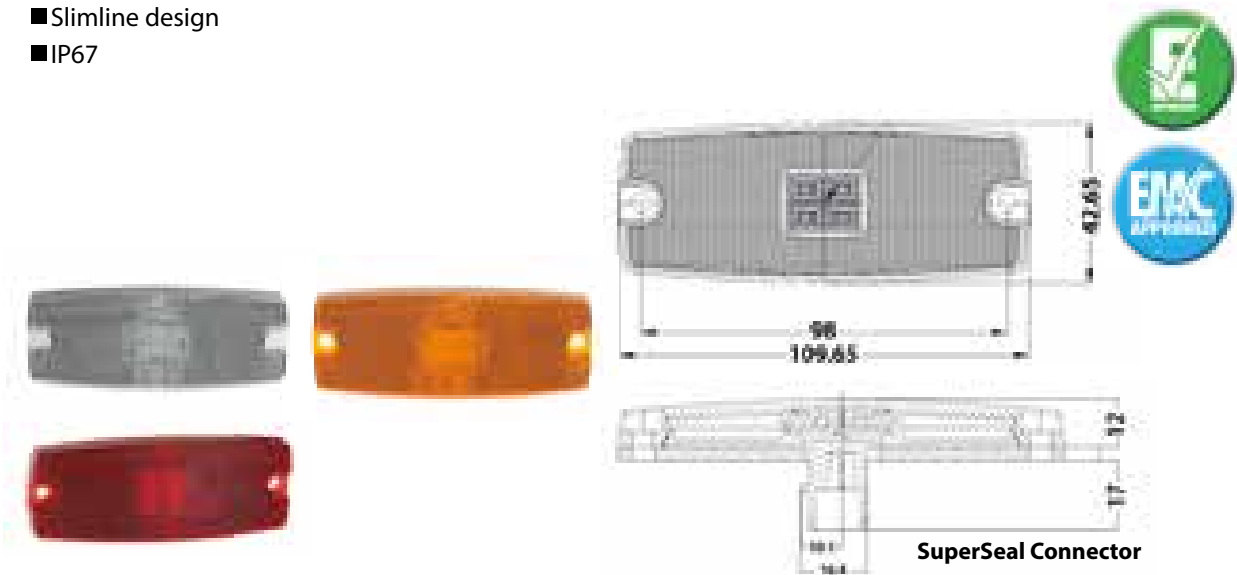

Display Pack	Bulk Pack	Position	Voltage	Connection	Orientation	Reflector	Mount
-	MP1658B	Front Clear	10/30v	Integral 2 Pin SuperSeal Socket	Horizontal	✓	Holes
-	MP1657B	Side Amber	10/30v		Horizontal	✓	Holes
-	MP1659B	Rear Red	10/30v		Horizontal	✓	Holes
-	MP1682B	Front Clear	10/30v	30cm of cable	Horizontal	✓	Holes
-	MP1681B	Side Amber	10/30v		Horizontal	✓	Holes
-	MP1683B	Rear Red	10/30v		Horizontal	✓	Holes

LED MARKER LAMP - (FM50)

- Commonly used on commercial vehicles
- Clip base
- MP8164B - Horizontal pendant bracket
- IP67

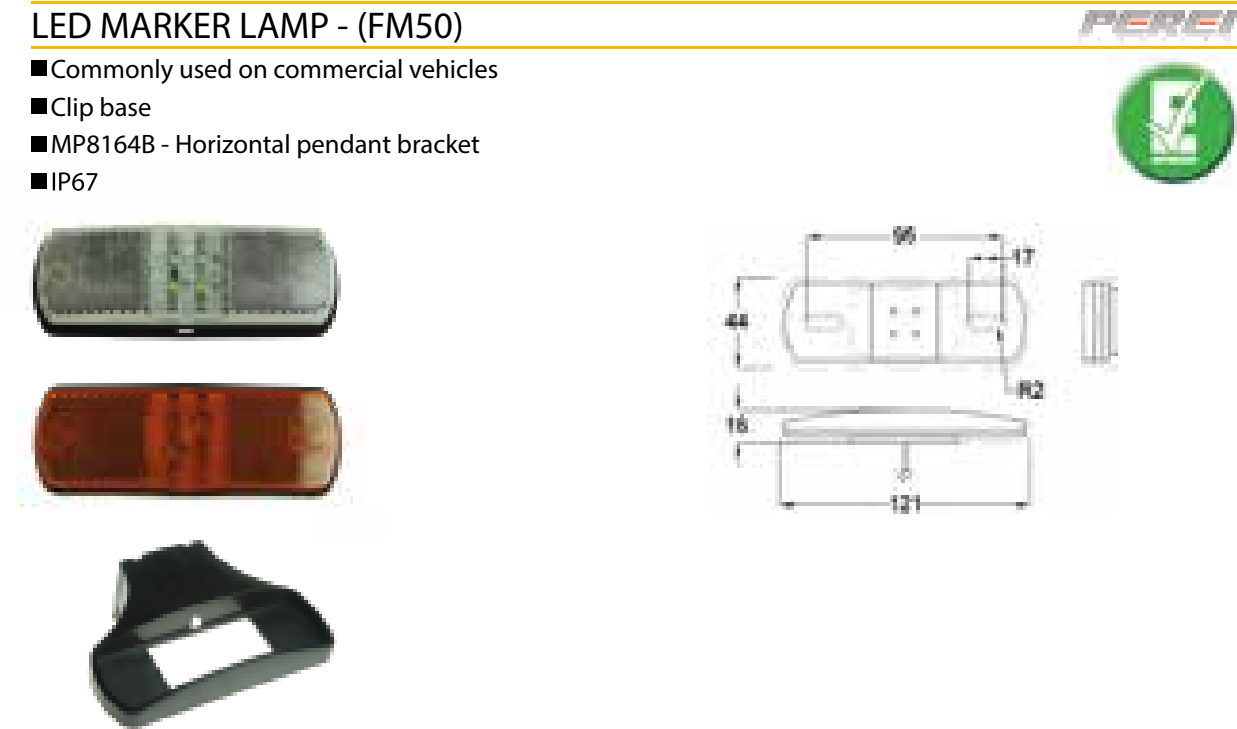

Display Pack	Bulk Pack	Position	Voltage	Connection	Orientation	Reflector	Mount
-	MP8142B	Front Clear	12/24v	50cm cable	Horizontal	✓	Holes
-	MP8141B	Side Amber	12/24v	50cm cable	Horizontal	✓	Holes

LED Marker Lamps

LED MARKER LAMP - (FM20)



- Best value range
- 1.8m length tail
- IP67
- Low profile design
- Dual orientation

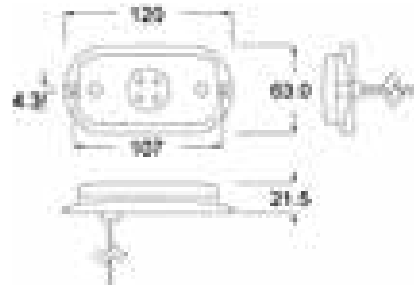

Display Pack	Bulk Pack	Position	Voltage	Connection	Orientation	Reflector	Mount
MP8172	MP8172B	Front Clear	10/30v	1.8m cable	Horiz. & Vert.	✓	Holes
MP8171	MP8171B	Side Amber	10/30v	1.8m cable	Horiz. & Vert.	✓	Holes
MP8173	MP8173B	Rear Red	10/30v	1.8m cable	Horiz. & Vert.	✓	Holes

LED MARKER LAMP - SLIMLINE



- Low profile
- Compact design
- IP66

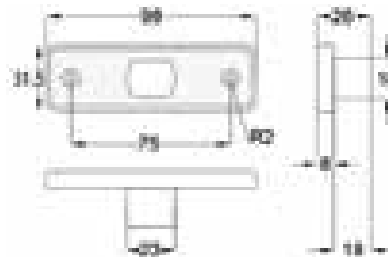
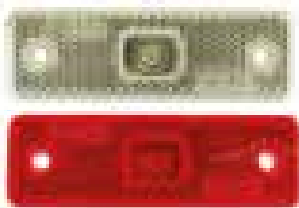

Display Pack	Bulk Pack	Position	Voltage	Connection	Orientation	Reflector	Mount
-	MP8776B	Front Clear	10/30v	23cm cable	Horizontal	✓	Holes
-	MP8775B	Side Amber	10/30v	23cm cable	Horizontal	✓	Holes
-	MP8777B	Rear Red	10/30v	23cm cable	Horizontal	✓	Holes

LED Outline Marker Lamps

RED/WHITE END OUTLINE MARKER



- Modern slimline design
- Universal assembly side mount
- IP66

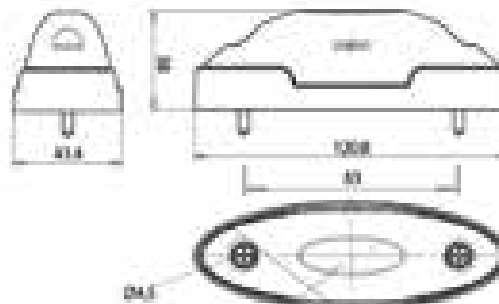

Display Pack	Bulk Pack	Voltage	Connection	Reflector	Mount
MP8981	MP8981B	10/30V	36cm cable	-	Studs

LED Outline Marker Lamps

RED/WHITE END OUTLINE MARKER - REFLECTOR

- Small, compact shape
- EPDM housing
- Ideal for welfare units
- IP68
- MP8702BQ is pre-wired for use with the Aspöck quick connect system. Supplied with 1m 2 x 0.75mm² rectangular cable and waterproof end cap.

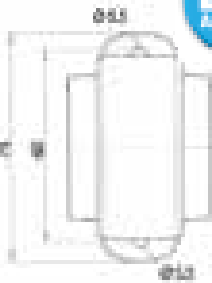

Display Pack	Bulk Pack	Voltage	Connection	Reflector	Mount
MP8702	MP8702B	10/30V	35cm cable	✓	Holes
-	MP8702BQ	10/30V	1m of square cable	✓	Holes

RED/WHITE END OUTLINE MARKER

- Rubber housing
- IP66

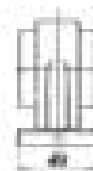
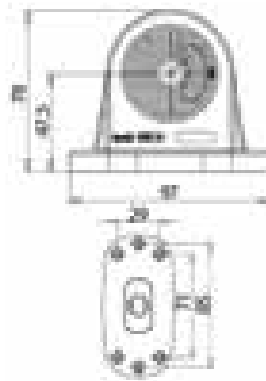

Display Pack	Bulk Pack	Voltage	Connection	Reflector	Mount
MP8709	MP8709B	10/30V	33cm cable	✓	Holes

RED OUTLINE MARKER LAMP - STAR DESIGN

- Rubber housing
- Modern 'star' design
- IP66

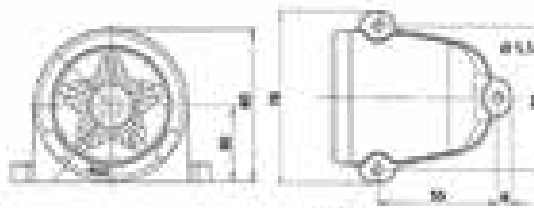

Display Pack	Bulk Pack	Voltage	Connection	Reflector	Mount
-	MP8712B	10/30V	29cm cable	-	Holes

LED Outline Marker Lamps

RED/WHITE END OUTLINE MARKER - STAR DESIGN

- Rubber housing
- Modern 'star' design
- IP66

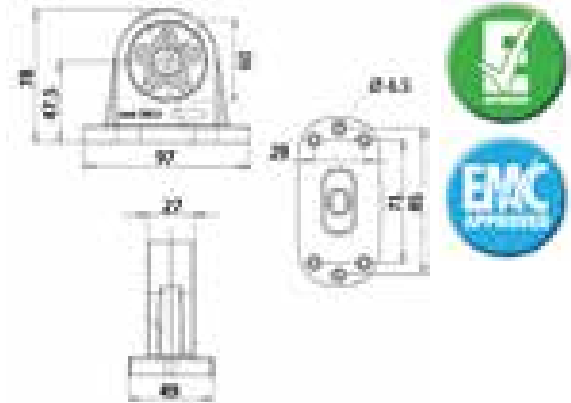

Display Pack	Bulk Pack	Voltage	Connection	Reflector	Mount
MP8715	MP8715B	10/30V	33cm cable	-	Holes

LED Clear Outline Marker Lamps

CLEAR OUTLINE FRONT POSITION MARKER LAMP

- Ideal for boat trailers
- IP68
- Front position marker with reflector and black rear lens
- EPDM housing

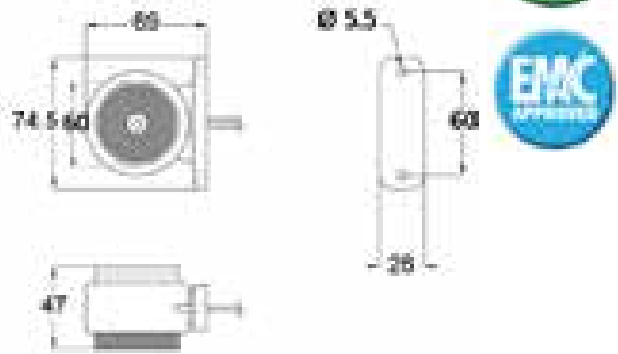

Display Pack	Bulk Pack	Voltage	Connection	Reflector	Mount
-	MP8700B	10/30V	35cm cable	✓	Holes

CLEAR OUTLINE FRONT POSITION MARKER - STAR DESIGN

- Rubber housing
- Modern 'star' design
- IP66

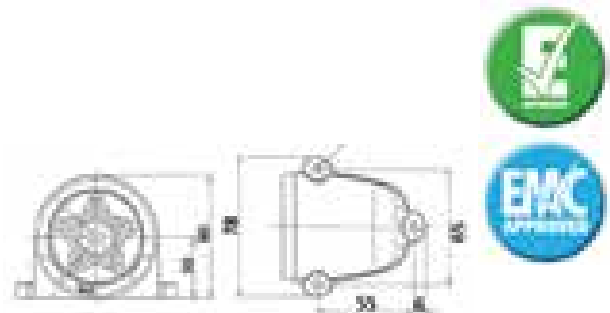

Display Pack	Bulk Pack	Voltage	Connection	Reflector	Mount
-	MP8713B	10/30V	20cm cable	-	Holes

LED Outline Marker Lamps

END OUTLINE MARKER LAMP - FLUSH MOUNT

- Rubber housing
- IP66/68
- Pre-wired for use with the Aspöck quick connect system. Supplied with 22cm 2 x 0.75mm² rectangular cable and waterproof end cap.



Bulk Pack	Colour	Voltage	Connection	Reflector	Mount
MP8757B	White	12/24V	22cm of square cable	-	Flush
MP8758B	Red	12/24V	22cm of square cable	-	Flush

90° RED/WHITE END OUTLINE MARKER LAMP

- Robust and flexible EPDM housing
- Suitable for longer vehicles
- IP66



Display Pack	Bulk Pack	Voltage	Connection	Reflector	Mount
MP8704L	MP8704BL	10/30V	18cm cable	✓	Holes
MP8704R	MP8704BR	10/30V	18cm cable	✓	Holes

45° RED/WHITE END OUTLINE MARKER LAMP

- Robust and flexible EPDM housing
- IP66



Display Pack	Bulk Pack	Voltage	Connection	Reflector	Mount
MP8706L	MP8706BL	10/30V	21cm cable	✓	Holes
MP8706R	MP8706BR	10/30V	21cm cable	✓	Holes

LED Outline Marker Lamps

90° RED/WHITE/AMBER OUTLINE MARKER LAMP

- Integral amber side marker
- Flexible and robust EPDM housing
- Innovative design
- MP8708BLQ & MP8708BRQ are pre-wired for use with the Aspöck quick connect system. Supplied with 1m 2 x 0.75mm² rectangular cable and waterproof end cap.
- IP68

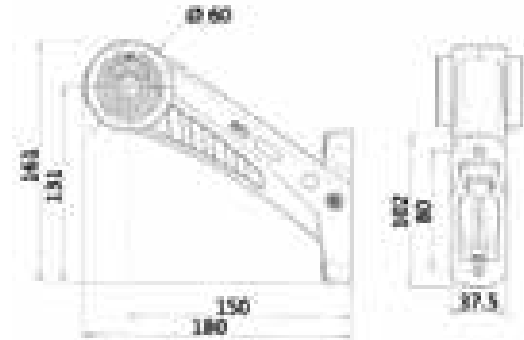

Display Pack	Bulk Pack	Voltage	Connection	Reflector	Mount
-	MP8708BL	10/30V	20cm cable	✓	Holes
-	MP8708BR	10/30V	20cm cable	✓	Holes
-	MP8708BLQ	10/30V	1m of square cable	✓	Holes
-	MP8708BRQ	10/30V	1m of square cable	✓	Holes

45° RED/WHITE/AMBER SHORT OUTLINE MARKER LAMP - STAR DESIGN

- EPDM housing
- IP66
- Modern 'star' design

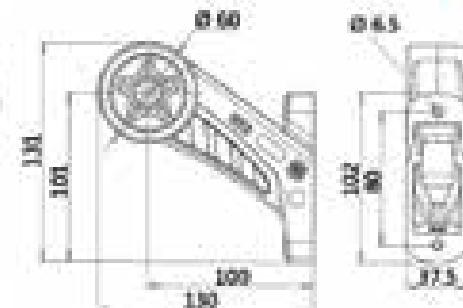
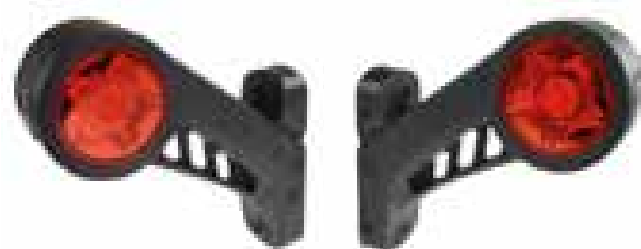

Display Pack	Bulk Pack	Voltage	Connection	Reflector	Mount
MP8710L	MP8710BL	10/30V	27cm cable	-	Holes
MP8710R	MP8710BR	10/30V	27cm cable	-	Holes

LED Outline Marker Lamps

45° RED/WHITE/AMBER LONG OUTLINE MARKER LAMP - STAR DESIGN

- EPDM housing
- IP66
- Modern 'star' design

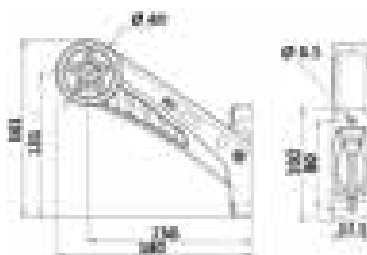

Display Pack	Bulk Pack	Voltage	Connection	Reflector	Mount
-	MP8711BL	10/30V	22cm cable	-	Holes
-	MP8711BR	10/30V	22cm cable	-	Holes

45° RED/WHITE SHORT OUTLINE MARKER LAMP - STAR DESIGN

- Rubber housing
- IP66
- Modern 'star' design

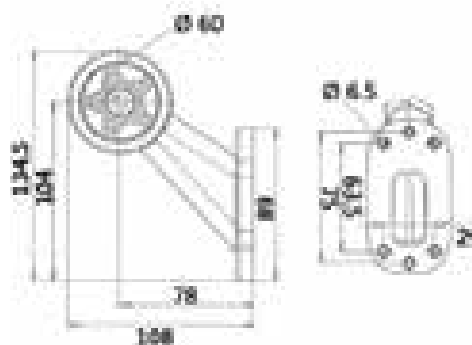

Display Pack	Bulk Pack	Voltage	Connection	Reflector	Mount
-	MP8714BL	10/30V	29cm cable	-	Holes
-	MP8714BR	10/30V	29cm cable	-	Holes

45° RED/WHITE LONG OUTLINE MARKER LAMP - STAR DESIGN

- Rubber housing
- IP66
- Modern 'star' design

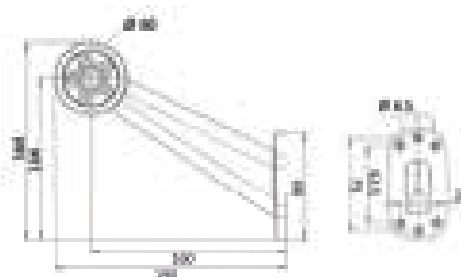

Display Pack	Bulk Pack	Voltage	Connection	Reflector	Mount
-	MP8718BL	10/30V	21cm cable	-	Holes
-	MP8718BR	10/30V	21cm cable	-	Holes

LED Outline Marker Lamps

90° RED/WHITE SHORT OUTLINE MARKER LAMP - STAR DESIGN



- Rubber housing
- IP66
- Modern 'star' design

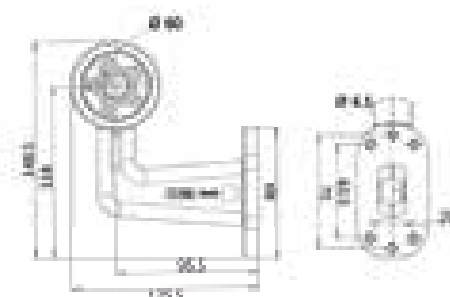

Display Pack	Bulk Pack	Voltage	Connection	Reflector	Mount
-	MP8720BL	10/30V	23cm cable	-	Holes
-	MP8720BR	10/30V	23cm cable	-	Holes

90° RED/WHITE LONG OUTLINE MARKER LAMP



- Rubber housing
- IP66
- Modern 'star' design

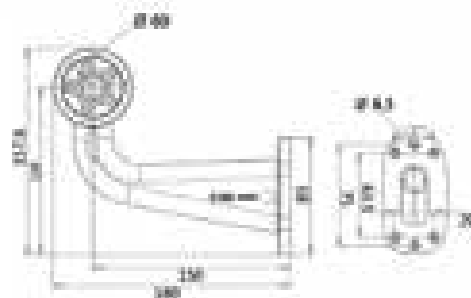

Display Pack	Bulk Pack	Voltage	Connection	Reflector	Mount
-	MP8716BL	10/30V	18cm cable	-	Holes
-	MP8716BR	10/30V	18cm cable	-	Holes

RED/WHITE/AMBER OUTLINE MARKER LAMP

- Rubber housing
- IP67
- Can be used with MP8827BL/BR



Display Pack	Bulk Pack	Voltage	Connection	Reflector	Mount
-	MP8991BLS	10/30V	21cm cable/Super Seal plug	-	2xM8 Studs
-	MP8991BRS	10/30V	21cm cable/Super Seal plug	-	2xM8 Studs

LED Combination Lamps

LED Combination Lamps

SQUARE COMBINATION LAMP - BUDGET



- Used on Maypole LED trailer boards
- Modern design
- IP67

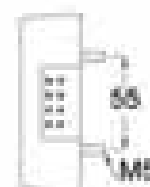
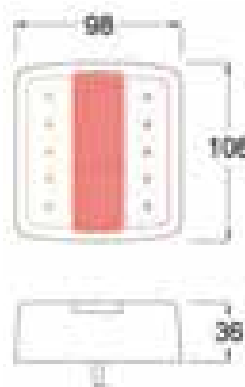

Display Pack	Bulk Pack	Stop	Tail	Indicator	Reflector	No. Plate	Reverse	Fog	Voltage	Connection	Mount
MP8893	MP8893B	✓	✓	✓	✓	✓			12V	15cm cable	Studs
-	MP8899B	✓	✓	✓	✓	✓			12V	95cm cable	Studs
MP8903	MP8903B	✓	✓	✓	✓	✓			12/24V	15cm cable	Studs
-	MP8909B	✓	✓	✓	✓	✓			12/24V	95cm cable	Studs

SQUARE COMBINATION LAMP - NUMBER PLATE OPTIONS

- Great value rear combination lamp
- IP67

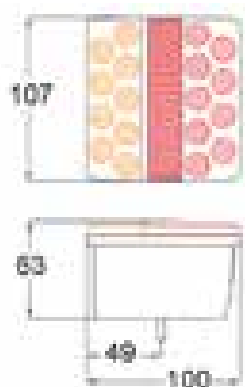

Display Pack	Bulk Pack	Stop	Tail	Indicator	Reflector	No. Plate	Reverse	Fog	Voltage	Connection	Mount
-	MP8581BR	✓	✓	✓	✓				12V	91cm cable	Studs
-	MP8585BL	✓	✓	✓	✓	✓			12V	91cm cable	Studs
-	MP8585BR	✓	✓	✓	✓	✓			12V	30cm cable	Studs

Maypole have an excellent range of LED combination lamps, suitable for a wide variety of trailer applications.



- Exclusive to Maypole
- Two 6 function LED combination lamps
- Slim line
- Modern chrome design

MP8603BL & MP8603BR

- Rectangular horizontal LED combination lamps
- 6 functions - stop/tail/indicator/reverse/fog/reflector
- 12/24v
- 54cm cable
- Integrated triangle reflector

MP8605BL & MP8605BR

- Triangular vertical LED combination lamps
- Direct LED replacement for Aspöck Earpoint 3 bulb lamps
- 6 functions - stop/tail/indicator/reverse/fog/reflector
- 12/24v
- 54cm cable
- Power take-off cable for marker and number plate lamps
- Can be installed 'wings-in' and 'wings-out'
- Integrated triangle reflector



LED Combination Lamps

SQUARE COMBINATION LAMP - SLIM LINE

- Great value rear combination lamp
- Compact design
- Low profile
- IP67

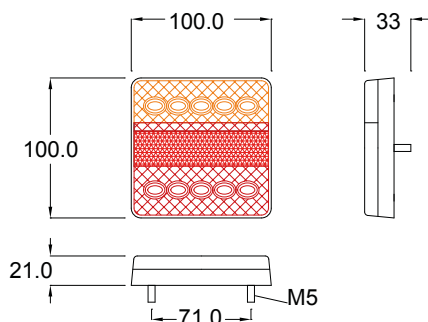

Display Pack	Bulk Pack	Stop	Tail	Indicator	Reflector	No. Plate	Reverse	Fog	Voltage	Connection	Mount
MP862	MP862B	✓	✓	✓	✓				12V	12.5cm cable	Studs

RECTANGULAR COMBINATION LAMP

- Varivolt combination lamp
- Fitted to MP255 range of LED varivolt trailer boards
- Innovative design

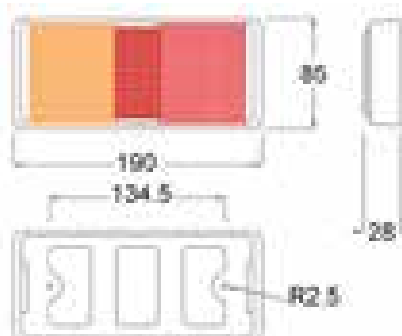
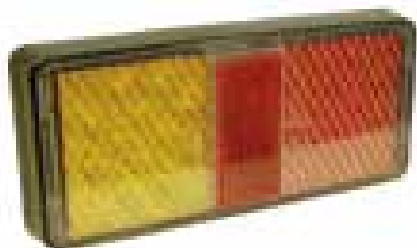

Display Pack	Bulk Pack	Stop	Tail	Indicator	Reflector	No. Plate	Reverse	Fog	Voltage	Connection	Mount
MP861	MP861B	✓	✓	✓	✓				10/30V	30cm cable	Holes

LARGE RECTANGULAR COMBINATION LAMP - EPDM BASE

- Heavy duty
- Robust design
- Ideal for agricultural trailers
- Flexible EPDM base reduces vibration
- IP67

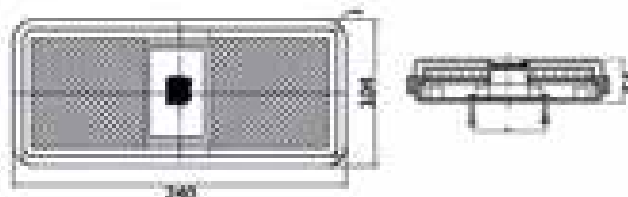

Display Pack	Bulk Pack	Stop	Tail	Indicator	Reflector	No. Plate	Reverse	Fog	Voltage	Connection	Mount
-	MP9640B	✓	✓	✓	✓				10-30V	40cm cable	Bolts

LED Combination Lamps

DOUBLE MODULE LAMP



- Suitable replacement for Ifor Williams trailers
- Robust design
- Horizontal or vertical mount
- IP67

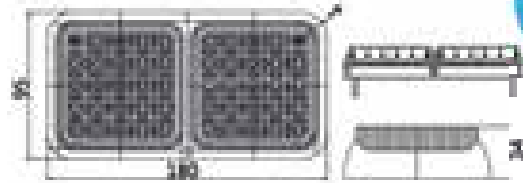
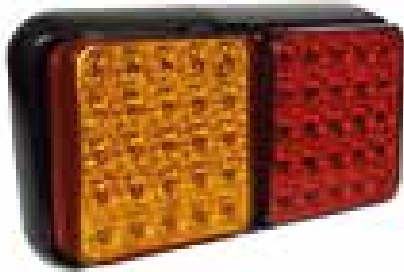

Display Pack	Bulk Pack	Stop	Tail	Indicator	Reflector	No. Plate	Reverse	Fog	Voltage	Connection	Mount
-	MP9637B	✓	✓	✓					10-30V	40cm cable	Studs

TRIPLE MODULE LAMP WITH REVERSE



- Suitable replacement for Ifor Williams trailers
- Robust design
- Modules 80 x 80
- Anti-vibration foam mount
- Horizontal and vertical mount
- IP67

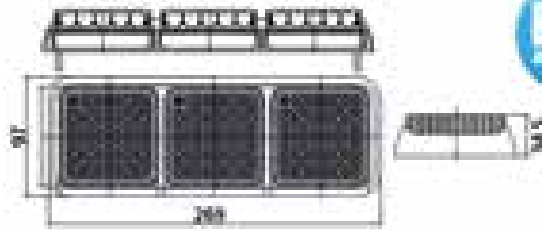

Display Pack	Bulk Pack	Stop	Tail	Indicator	Reflector	No. Plate	Reverse	Fog	Voltage	Connection	Mount
-	MP9638B	✓	✓	✓			✓		10-30V	40cm cable	Bolts

TRIPLE MODULE LAMP WITH FOG



- Suitable replacement for Ifor Williams trailers
- Robust design
- Anti-vibration foam mount
- IP67

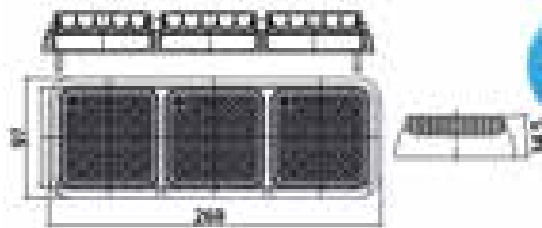
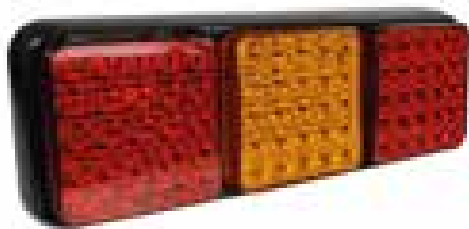

Display Pack	Bulk Pack	Stop	Tail	Indicator	Reflector	No. Plate	Reverse	Fog	Voltage	Connection	Mount
-	MP9639B	✓	✓	✓				✓	10-30V	40cm cable	Bolts

LED Combination Lamps

RECTANGULAR COMBINATION LAMP - 6 FUNCTIONS



- Exclusive to Maypole
- Integral reflector triangle
- IP67
- Modern chrome appearance
- Also used on trailer boards

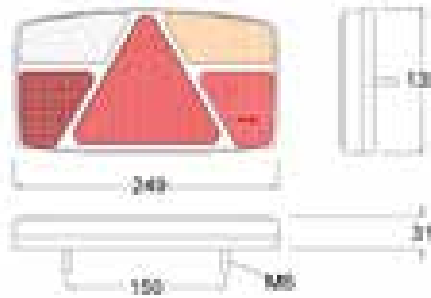
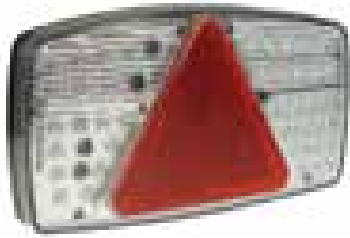

Display Pack	Bulk Pack	Stop	Tail	Indicator	Reflector	No. Plate	Reverse	Fog	Voltage	Connection	Mount
MP8603L	MP8603BL	✓	✓	✓	✓		✓	✓	10/30V	54cm cable	Studs
MP8603R	MP8603BR	✓	✓	✓	✓		✓	✓	10/30V	54cm cable	Studs

RECTANGULAR COMBINATION LAMP - 6 / 7 FUNCTIONS



- Innovative design
- IP66
- Integral reflector triangle

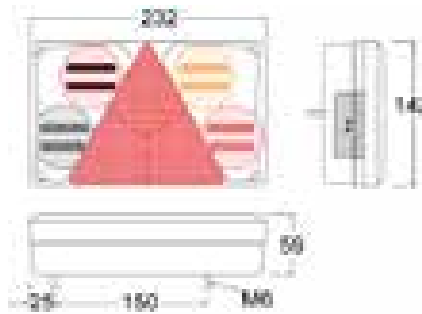

Display Pack	Bulk Pack	Stop	Tail	Indicator	Reflector	No. Plate	Reverse	Fog	Voltage	Connection	Mount
-	MP8823BL	✓	✓	✓	✓		✓	✓	10/30V	30cm cable	Studs
-	MP8823BR	✓	✓	✓	✓		✓	✓	10/30V	30cm cable	Studs
-	MP8825BL	✓	✓	✓	✓	✓	✓	✓	10/30V	34cm cable	Studs
-	MP8825BR	✓	✓	✓	✓	✓	✓	✓	10/30V	34cm cable	Studs

RECTANGULAR COMBINATION LAMP - NEON LIGHT EFFECT



- Modern 'light track' system
- IP68
- Unique shape which makes the lamp recognisable and highly visible on the road
- Fitted with a translucent lens over the tail light function to give a modern 'neon light' glow effect

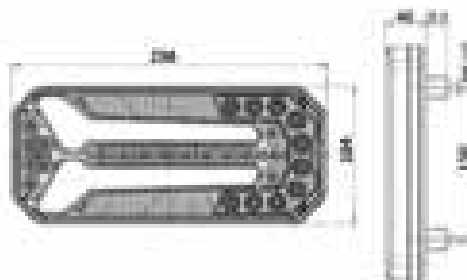

Display Pack	Bulk Pack	Stop	Tail	Indicator	Reflector	No. Plate	Reverse	Fog	Voltage	Connection	Mount
-	MP8830B	✓	✓	✓	✓		✓	✓	10/30V	200cm cable	Studs

LED Combination Lamps

RECTANGULAR COMBINATION LAMP - SLIM LINE

- Modern slim line design
- Multifunction
- IP68

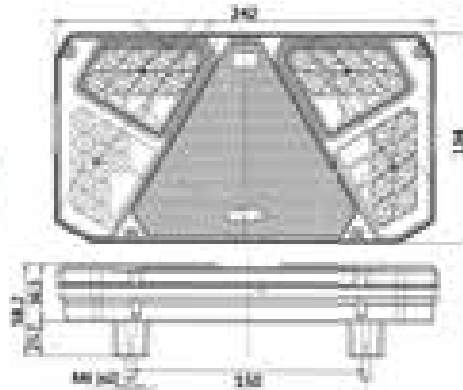

Display Pack	Bulk Pack	Stop	Tail	Indicator	Reflector	No. Plate	Reverse	Fog	Voltage	Connection	Mount
-	MP8826BL	✓	✓	✓	✓		✓	✓	10/30V	200cm cable	Studs
-	MP8826BR	✓	✓	✓	✓		✓	✓	10/30V	200cm cable	Studs
-	MP8824BL	✓	✓	✓	✓	✓	✓	✓	10/30V	200cm cable	Studs
-	MP8824BR	✓	✓	✓	✓	✓	✓	✓	10/30V	200cm cable	Studs

REAR COMMERCIAL LAMP WITH QUICK FIT SYSTEM

- Ideal for heavy (O2) commercial trailer applications or large agricultural trailers
- 2 x 2 way Super Seal outlet sockets for number plate & outline marker lamps
- Full function
- Can be used with MP8991BLS/BRS stalk marker lamps
- Modern design
- IP67

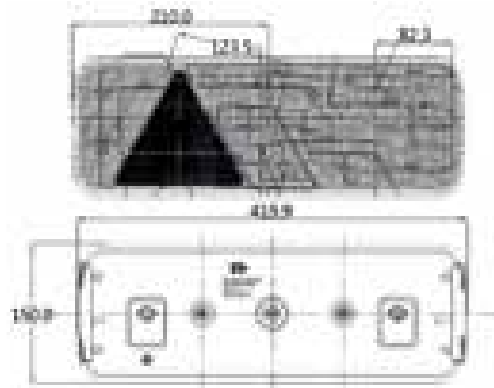
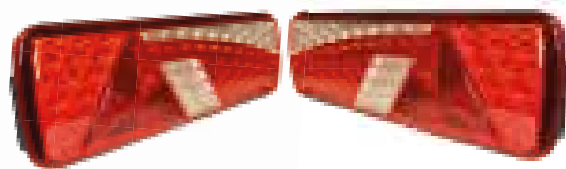

Bulk Pack	Stop	Tail	Indicator	Reflector	Reverse	Fog	Voltage	Connection	Mount
MP8827BL	✓	✓	✓	✓	✓	✓	10/30V	55cm cable/2x2 way socket	Holes
MP8827BR	✓	✓	✓	✓	✓	✓	10/30V	55cm cable/2x2 way socket	Holes

LED Combination Lamps

ROUND COMBINATION AND REVERSE LAMPS

- Robust construction
- Common truck application
- IP67
- Plastic base available for extra mounting options
- MP8674B has EMC approval

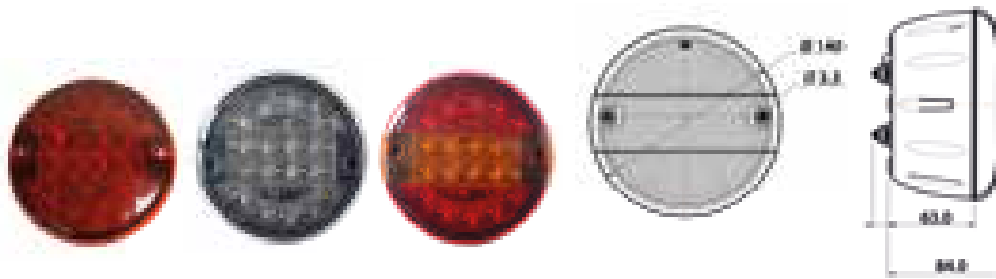

Display Pack	Bulk Pack	Stop	Tail	Indicator	Reflector	No. Plate	Reverse	Fog	Voltage	Connection	Mount	
-	MP8676B							✓	9/30V	Spade	Studs	
-	MP8677B						✓		9/30V	Spade	Studs	
MP8674	MP8674B	✓	✓	✓					9/30V	Spade	Studs	
-	MP8679B	Plastic Base										

TRIANGLE MODULAR COMBINATION LAMP - COMPACT

- Slim line design
- Innovative compact design
- IP66



Display Pack	Bulk Pack	Stop	Tail	Indicator	Reflector	No. Plate	Reverse	Fog	Voltage	Connection	Mount
-	MP8693BL	✓	✓	✓	✓		✓		10/30V	30cm cable	Studs
-	MP8695BR	✓	✓	✓	✓			✓	10/30V	30cm cable	Studs

TRIANGLE COMBINATION LAMP - SLIM LINE / CHROME

- Exclusive to Maypole
- Power take-off cable for marker and number plate lamps
- Suitable LED replacements for Aspöck Earpoint 3 bulb lamps
- IP67
- Can be installed 'wings-in' and 'wings-out'

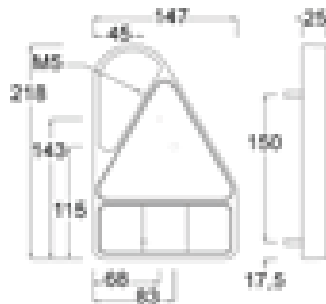
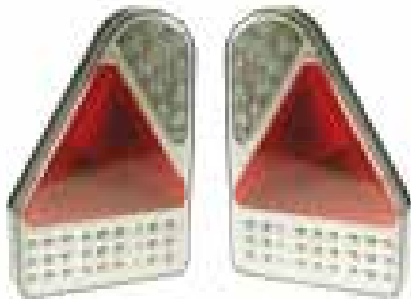

Display Pack	Bulk Pack	Stop	Tail	Indicator	Reflector	No. Plate	Reverse	Fog	Voltage	Connection	Mount
MP8605L	MP8605BL	✓	✓	✓	✓		✓	✓	10/30V	45cm cable	Studs
MP8605R	MP8605BR	✓	✓	✓	✓		✓	✓	10/30V	45cm cable	Studs

LED Combination Lamps

SLIM LINE COMBINATION LAMP - STOP, TAIL & INDICATOR

- Modern, slim line design
- Vertical and horizontal mount
- Ideal for enclosed car transporter trailers
- IP66



Display Pack	Bulk Pack	Stop	Tail	Indicator	Reflector	No. Plate	Reverse	Fog	Voltage	Connection	Mount
-	MP8843B	✓	✓	✓					10/30V	20cm cable	Holes

SLIM LINE COMBINATION LAMP - REVERSE & FOG

- Modern, slim line design
- Horizontal mount
- Special order only
- Ideal for enclosed car transporter trailers
- IP66/68



Display Pack	Bulk Pack	Stop	Tail	Indicator	Reflector	No. Plate	Reverse	Fog	Voltage	Connection	Mount
-	MP8841B						✓	✓	10/30V	20cm cable	Holes

SLIM LINE REAR LAMP - STOP

- High mounted lamp act as a third brake lamp on a trailer
- Modern, slim line design
- Horizontal mount
- Ideal for enclosed car transporter trailers
- IP66

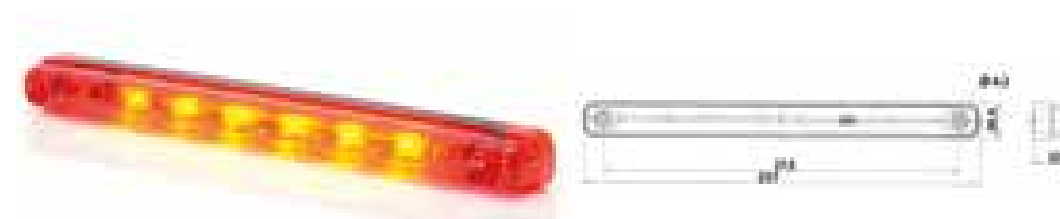

Display Pack	Bulk Pack	Stop	Tail	Indicator	Reflector	No. Plate	Reverse	Fog	Voltage	Connection	Mount
-	MP8881B	✓							10/30V	39cm cable	Holes

LED Fog & Reverse Lamps

LED Fog Lamps

BUDGET REAR FOG LAMP



- Modern, slim line design
- 4.5mm mounting holes
- Used on LED trailer board ranges
- Horizontal and vertical mount
- IP65

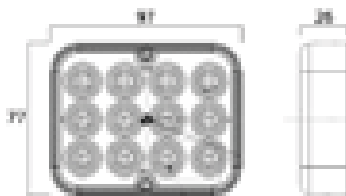
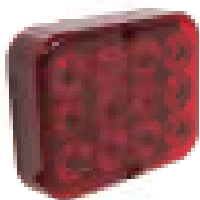

Display Pack	Bulk Pack	Voltage	Connection	Mount
MP863	MP863B	12V	500mm cable	Holes
MP8631	MP8631B	10/30V	500mm cable	Holes

FOG LAMP - SLIM LINE



- Great value fog lamp
- Slim line profile
- Modern design
- IP66

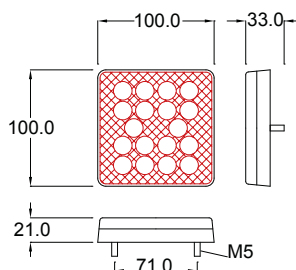

Display Pack	Bulk Pack	Voltage	Connection	Mount
MP9634	MP9634B	10/30V	30cm cable	Studs

FOG LAMP MODULE



- Robust construction
- Clip in plastic base
- IP67

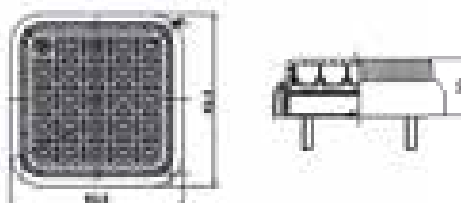

Display Pack	Bulk Pack	Voltage	Connection	Mount
-	MP9631B	10/30V	40cm cable	Studs

LED Reverse Lamp

REVERSE LAMP MODULE



- Clip in plastic base
- Robust construction
- IP67

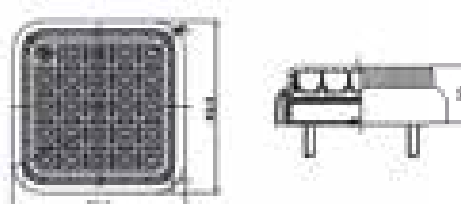

Display Pack	Bulk Pack	Voltage	Connection	Mount
-	MP9635B	10-30V	40cm cable	Studs

LED Number Plate Lamps

LED Number Plate Lamps

NUMBER PLATE LAMP - STUD MOUNT



- Low power consumption
- Supplied with mounting bolts
- Compact design
- IP67

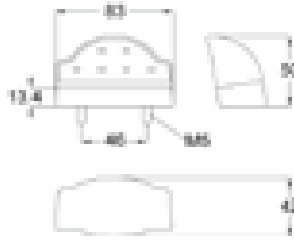

Display Pack	Bulk Pack	Voltage	Connection	Mount
MP8227	MP8227B	10-30V	32cm cable	Studs

NUMBER PLATE LAMP - CLIP ON BASE



- Compact design
- Clip on base
- Great value number plate lamp
- Design for easy fitting
- IP67

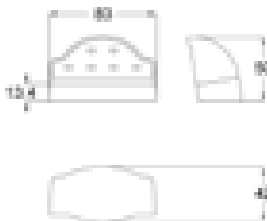

Display Pack	Bulk Pack	Voltage	Connection	Mount
MP8228	MP8228B	10-30V	30cm cable	Holes

NUMBER PLATE LAMP - HIGH PROFILE



- Robust construction
- High profile design
- IP67

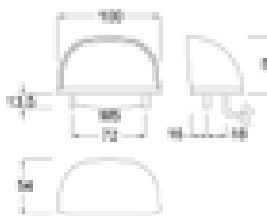

Display Pack	Bulk Pack	Voltage	Connection	Mount
-	MP8223B	10-30V	30cm cable	2 x M5 Studs

NUMBER PLATE LAMP



- Robust construction
- Universal assembly
- IP68

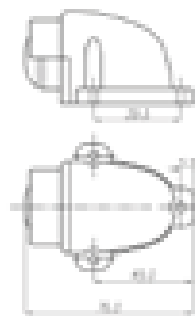

Display Pack	Bulk Pack	Voltage	Connection	Mount
-	MP8229B	10-30V	30cm cable	Studs

Bulb Marker Lamps

Bulb Marker Lamps

MARKER LAMP

- Compact design
- Made in Europe
- High profile design
- Supplied with 1x 239 bulb (MP7799)

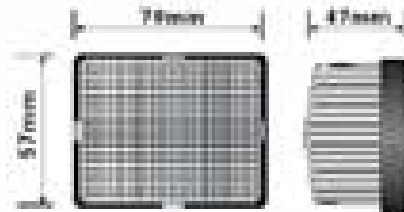

Display Pack	Bulk Pack	Position	Voltage	Connection	Orientation	Reflector	Mount
-	MP157B	Front Clear	12/24v	Spade	Horizontal	-	Holes

MARKER LAMP - (0804)

- Supplied without 1x 239 bulb (MP7799)

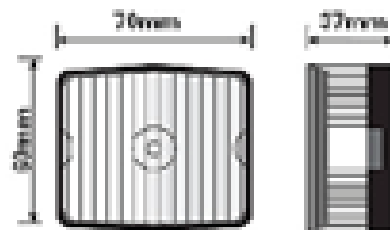

Display Pack	Bulk Pack	Position	Voltage	Connection	Orientation	Reflector	Mount
MP167	MP167B	Front Clear	12/24v	Spade	Horizontal	-	Holes

MARKER LAMP - (881/883/882)

- Compact design
- Supplied without 1x 501 bulb

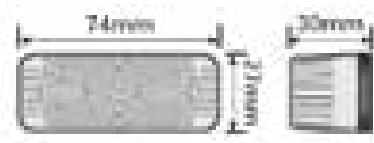
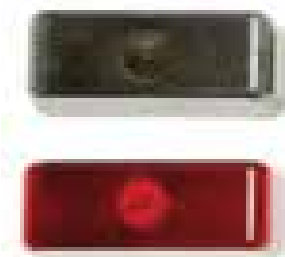

Bulk Pack	Box Qty	Position	Voltage	Connection	Orientation	Reflector	Mount
MP968B	10	Front Clear	12v	Spade	Horiz. & Vert.	✓	Holes
MP969B	10	Rear Red	12v	Spade	Horiz. & Vert.	✓	Holes

Bulb Marker Lamps

MARKER LAMP - (FA/FL/FP.09)



■ Made in Europe ■ Small profile ■ Bulb included

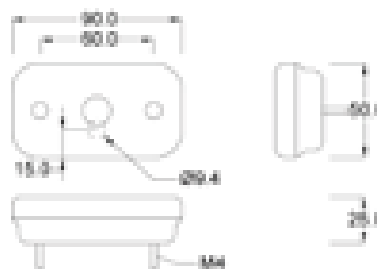

Display Pack	Bulk Pack	Position	Voltage	Connection	Orientation	Reflector	Mount
-	MP7473B	Front Clear	12v	Spade	Horizontal	✓	Holes
-	MP7472B	Side Amber	12v	Spade	Horizontal	✓	Holes

MARKER LAMP -(V903/V905/V902)



■ Made in Europe ■ Long line design ■ Bulb included

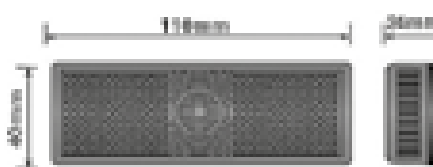
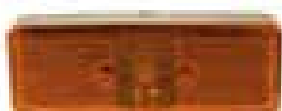
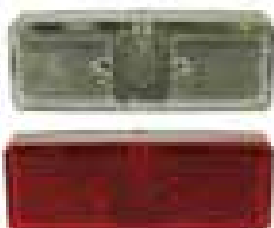

Display Pack	Bulk Pack	Position	Voltage	Connection	Orientation	Reflector	Mount
MP8185	MP8185B	Front Clear	12v	Spade	Horizontal	✓	Holes
-	MP8184B	Side Amber	12v	Spade	Horizontal	✓	Holes
-	MP8183B	Rear Red	12v	Spade	Horizontal	✓	Holes

MARKER LAMP - (0724/0705)



■ Caravan replacement ■ Slim line design ■ Bulb not included



Display Pack	Bulk Pack	Position	Voltage	Connection	Orientation	Reflector	Mount
MP169	MP169B	Front Clear	12v	Spade	Horizontal	✓	Holes

MARKER LAMP - SLIM LINE

■ Slim line design ■ Bulb included

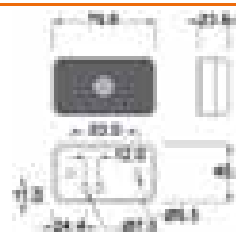
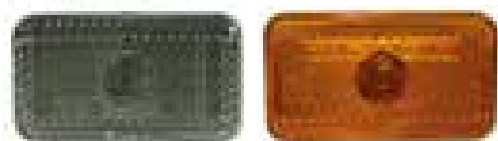

Display Pack	Bulk Pack	Position	Voltage	Connection	Orientation	Reflector	Mount
MP8735	MP8735B	Front Clear	12v	Spade	Horizontal	✓	Holes
MP8725	MP8725B	Side Amber	12v	Spade	Horizontal	✓	Holes

Bulb Marker Lamps

MARKER LAMP - (430/432)



- Rubber casing and bracket
- Bulb included



Display Pack	Bulk Pack	Position	Voltage	Connection	Orientation	Reflector	Mount
-	MP842B	Front Clear	12v	23cm cable	Horiz. & Vert.	-	Holes
-	MP876B	Side Amber	12v	23cm cable	Horiz. & Vert.	-	Holes

Bulb Outline Marker Lamps

OUTLINE MARKER LAMP - (925/601)



- Made in Europe
- Bulb included

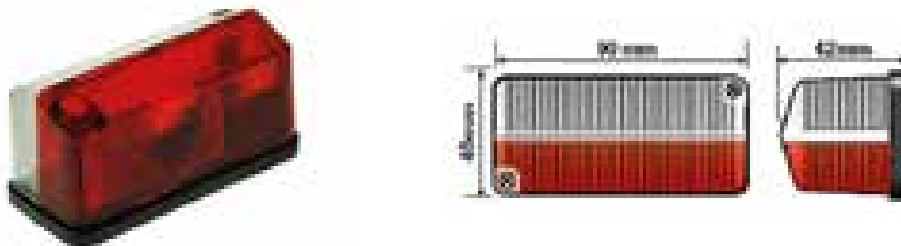

Display Pack	Bulk Pack	Position	Voltage	Connection	Orientation	Mount
MP874	MP874B	Red/White	12v	Spade	Vertical	Holes

OUTLINE MARKER LAMP - BRACKET (925/1L-6)



- Made in Europe
- Complete with bracket
- Bulb included



Display Pack	Bulk Pack	Position	Voltage	Connection	Orientation	Mount
MP8191	MP8191B	Red/White	12v	Spade	Vertical	Holes

Bulb Outline Marker Lamps

OUTLINE MARKER LAMP - COMPACT (0806)



- Compact design
- Low profile
- Bulb not included

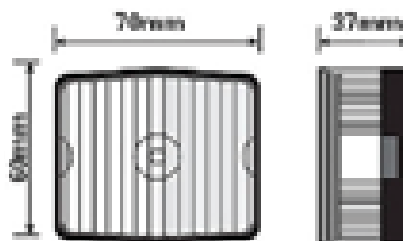

Display Pack	Bulk Pack	Position	Voltage	Connection	Orientation	Mount
MP166	MP166B	Red/White	12v	Spade	Vertical	Holes

OUTLINE MARKER LAMP - (428)



- Suitable for Ifor Williams trailers
- Rubber housing
- Bulb included
- Lens are in packs of 10

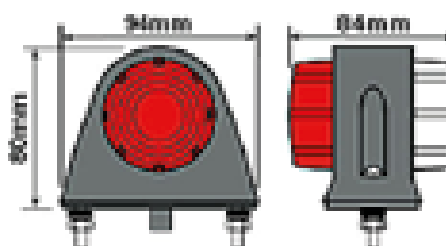

Display Pack	Bulk Pack	Position	Voltage	Connection	Orientation	Mount
MP37	MP37B	Red/White	12v	21cm cable	-	Holes
-	MP107BR	Red Lens				
-	MP107BW	White Lens				

RED/WHITE LOW OUTLINE MARKER LAMP



- IP56
- Bulb not included

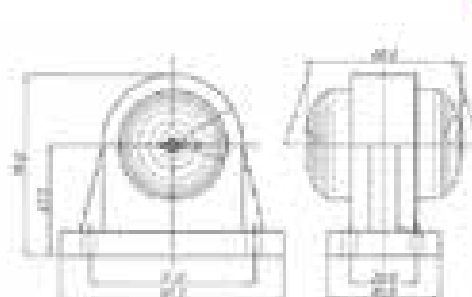

Display Pack	Bulk Pack	Voltage	Connection	Reflector	Mount
MP8761	MP8761B	12/24V	20cm cable	-	Holes

Bulb Outline Marker Lamps

45° RED/WHITE STALK MARKER LAMP

- Bulb not included
- IP56

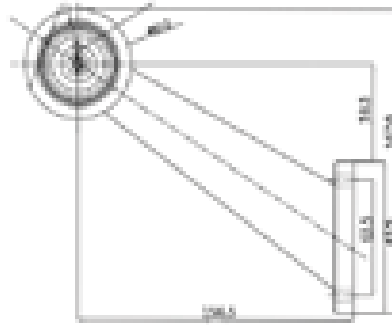

Display Pack	Bulk Pack	Voltage	Connection	Reflector	Mount
-	MP8765B	12/24V	27cm cable	-	Holes

90° RED/WHITE SHORT STALK MARKER LAMP

- Bulb not included
- IP56

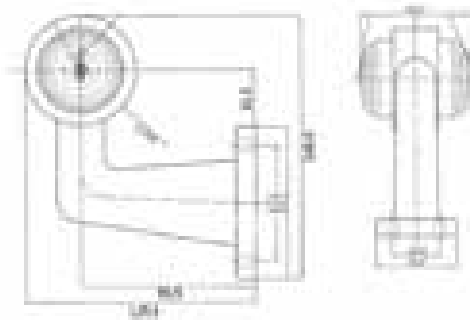

Display Pack	Bulk Pack	Voltage	Connection	Reflector	Mount
MP8764	MP8764B	12/24V	28cm cable	-	Holes

90° RED/WHITE LONG STALK MARKER LAMP

- Bulb not included
- IP56

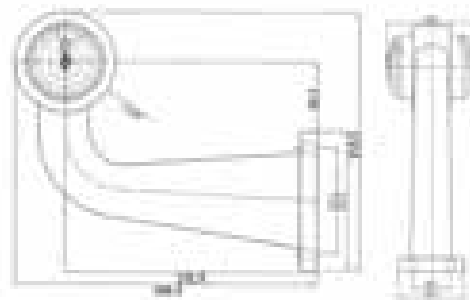

Display Pack	Bulk Pack	Voltage	Connection	Reflector	Mount
MP8763	MP8763B	12/24V	24cm cable	-	Holes

Bulb Combination Lamps

Bulb Combination Lamps

SQUARE COMBINATION LAMP



- Manufactured in the UK
- Bulbs included
- Horizontal and vertical orientation

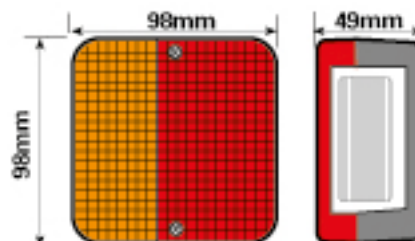

Display Pack	Bulk Pack	Stop	Tail	Indicator	Reflector	No. Plate	Reverse	Fog	Voltage	Connection	Mount	
MP3	MP3B	✓	✓	✓		✓			12V	Spade	Holes	
MP5	MP5B	Spare Lens										

SQUARE COMBINATION LAMP



- Used on Maypole trailer boards
- Bulb included
- Horizontal orientation

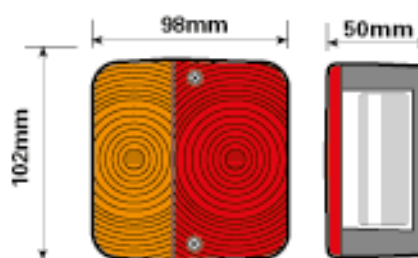

Display Pack	Bulk Pack	Stop	Tail	Indicator	Reflector	No. Plate	Reverse	Fog	Voltage	Connection	Mount	
MP17	MP17B	✓	✓	✓		✓			12V	Spade	Holes	
MP20	MP20B	Spare Lens										

SQUARE COMBINATION LAMP - (FP18.004/FP11.094)



- Suitable for Erde trailers
- MP8263B supplied with AJ.BA quickfit socket
- Horizontal orientation
- Bulbs included



Display Pack	Bulk Pack	Stop	Tail	Indicator	Reflector	No. Plate	Reverse	Fog	Voltage	Connection	Mount	
-	MP8261B	✓	✓	✓		✓			12V	Spade	Holes	
-	MP8263B	✓	✓	✓		✓			12V	Quick Fit	Holes	
-	MP8262B	Spare Lens										

Bulb Combination Lamps

SQUARE COMBINATION LAMP - (9089.00.12V/9088.00.12V)



- Horizontal and vertical orientation
- Bulbs included

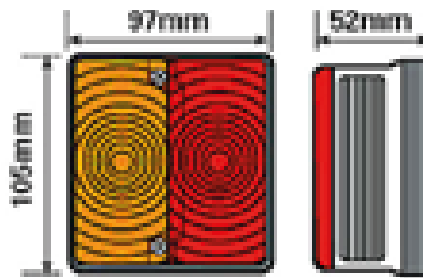
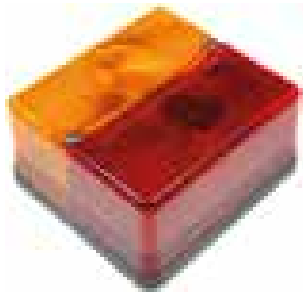

Display Pack	Bulk Pack	Stop	Tail	Indicator	Reflector	No. Plate	Reverse	Fog	Voltage	Connection	Mount
-	MP8791B	✓	✓	✓					12V	Spade	Holes
MP879	MP879B	✓	✓	✓		✓			12V	Spade	Holes
-	MP881B	Spare Lens for MP879B									

RECTANGULAR COMBINATION LAMP - (9002.50.12V)



- High profile
- Bulbs included
- Horizontal and vertical orientation

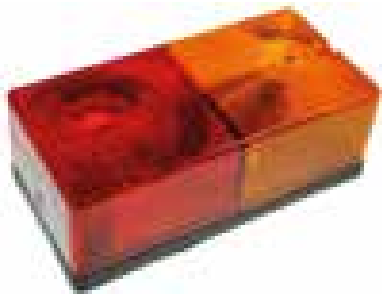

Display Pack	Bulk Pack	Stop	Tail	Indicator	Reflector	No. Plate	Reverse	Fog	Voltage	Connection	Mount
MP6	MP6B	✓	✓	✓		✓			12V	Spade	Holes

RECTANGULAR COMBINATION LAMP - BUDGET



- Plastic base
- Made in the UK
- Horizontal and vertical orientation
- Bulbs included



Display Pack	Bulk Pack	Stop	Tail	Indicator	Reflector	No. Plate	Reverse	Fog	Voltage	Connection	Mount
MP10	MP10B	✓	✓	✓		✓			12V	Spade	Holes
MP12	MP12B	Spare Lens									

Bulb Combination Lamps

RECTANGULAR COMBINATION LAMP - (9020.00.12V)



- Oval design
- Horizontal and vertical orientation
- Bulbs included

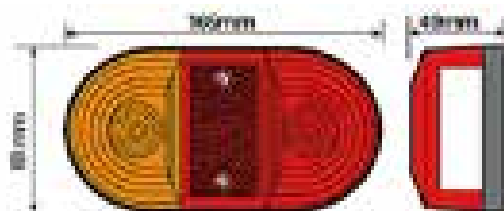

Display Pack	Bulk Pack	Stop	Tail	Indicator	Reflector	No. Plate	Reverse	Fog	Voltage	Connection	Mount	
MP36	MP36B	✓	✓	✓	✓	✓			12V	21cm cable	Holes	
-	MP34B	Spare Lens										

RECTANGULAR COMBINATION LAMP - 5 FUNCTIONS

- Made in Europe
- Bulbs included
- Horizontal orientation

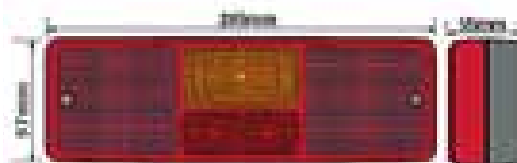

Display Pack	Bulk Pack	Stop	Tail	Indicator	Reflector	No. Plate	Reverse	Fog	Voltage	Connection	Mount
MP30L	MP30BL	✓	✓	✓	✓	✓		✓	12V	Spade	Holes
MP30R	MP30BR	✓	✓	✓	✓	✓		✓	12V	Spade	Holes

RECTANGULAR COMBINATION LAMP - (FP15.115/FP.16.105)



- Made in Europe
- Horizontal and vertical orientation
- Bulbs included



Display Pack	Bulk Pack	Stop	Tail	Indicator	Reflector	No. Plate	Reverse	Fog	Voltage	Connection	Mount	
-	MP8501B	✓	✓	✓	✓	✓		✓	12V	Spade	Holes	
-	MP8504B	✓	✓	✓	✓	✓	✓		12V	Spade	Holes	
-	MP8502B	Spare Lens for MP8501B										

Bulb Combination Lamps

RECTANGULAR COMBINATION LAMP - (5800)



- Made in Europe
- Horizontal orientation
- Bulbs included

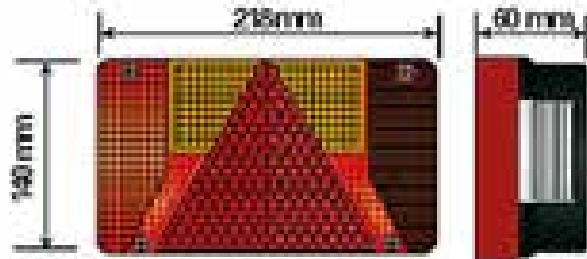

Display Pack	Bulk Pack	Stop	Tail	Indicator	Reflector	No. Plate	Reverse	Fog	Voltage	Connection	Mount	
-	MP800BL	✓	✓	✓	✓	✓		✓	12V	Spade	Holes	
-	MP800BR	✓	✓	✓	✓	✓		✓	12V	Spade	Holes	
-	MP802BL	Spare Lens for MP800BL										
-	MP802BR	Spare Lens for MP800BR										

RECTANGULAR COMBINATION LAMP - (6800)



- Made in Europe
- Bulbs included

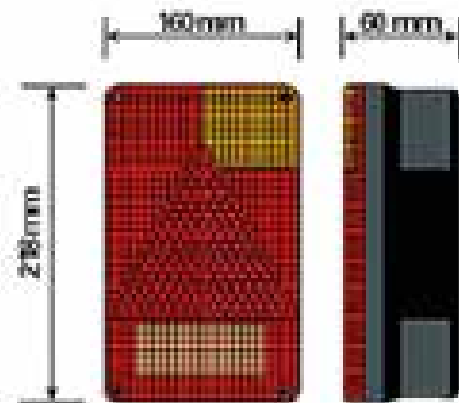

Display Pack	Bulk Pack	Stop	Tail	Indicator	Reflector	No. Plate	Reverse	Fog	Voltage	Connection	Mount	
-	MP805BL	✓	✓	✓	✓	✓		✓	12V	Spade	Holes	
-	MP805BR	✓	✓	✓	✓	✓		✓	12V	Spade	Holes	
-	MP806BL	Spare Lens for MP805BL										
-	MP806BR	Spare Lens for MP805BR										

Bulb Combination Lamps

RECTANGULAR COMBINATION LAMP - (9004.00.12V)



- As used on some Ifor Williams trailers
- Robust construction
- Bulbs included

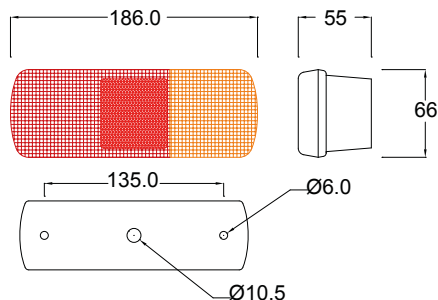

Display Pack	Bulk Pack	Stop	Tail	Indicator	Reflector	No. Plate	Reverse	Fog	Voltage	Connection	Mount
-	MP8803B	✓	✓	✓	✓				12V	Spade	Holes

RECTANGULAR COMBINATION LAMP - (RL85)



- Made in Europe
- Bulbs included

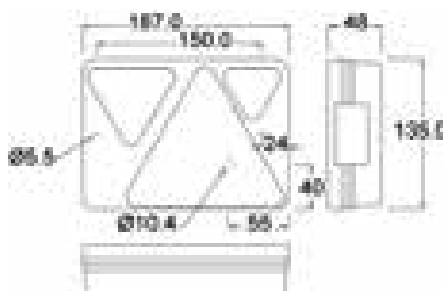

Display Pack	Bulk Pack	Stop	Tail	Indicator	Reflector	No. Plate	Reverse	Fog	Voltage	Connection	Mount
-	MP894BL	✓	✓	✓	✓	✓		✓	12V	Spade	Holes
-	MP894BR	✓	✓	✓	✓	✓		✓	12V	Spade	Holes
-	MP8940BL	✓	✓	✓	✓	✓	✓		12V	Spade	Holes

RECTANGULAR COMBINATION LAMP - (RL96)



- Made in Europe
- Used on Maypole trailers
- AJ.BA 5 Pin quick fit connector

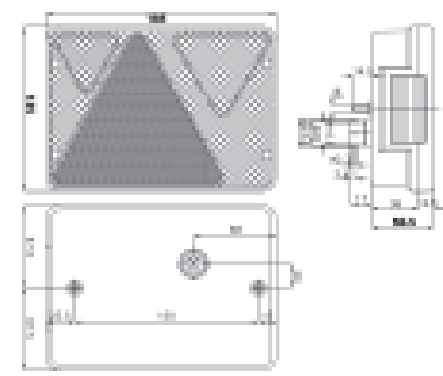

Display Pack	Bulk Pack	Stop	Tail	Indicator	Reflector	No. Plate	Reverse	Fog	Voltage	Connection	Mount	
-	MP89430BL	✓	✓	✓	✓	✓		✓	12v	5 Pin Quick	Holes	
-	MP8943BR	✓	✓	✓	✓	✓		✓	12v	Connect	Holes	
-	MP8947B	Spare Lens for MP89430BL										
-	MP8949B	Spare Lens for MP8943BR										

Bulb Combination Lamps

RECTANGULAR COMBINATION LAMP - (FP.84.117MA/FP.84.137MA) LONG

- Made in Europe
- Bulbs not included
- Horizontal orientation



Display Pack	Bulk Pack	Stop	Tail	Indicator	Reflector	No. Plate	Reverse	Fog	Voltage	Connection	Mount
-	MP749BL	✓	✓	✓	✓	✓	✓	✓	12V	Spade	Holes
-	MP749BR	✓	✓	✓	✓	✓	✓	✓	12V	Spade	Holes

RECTANGULAR COMBINATION LAMP - (FP.44.117/FP.44.137) SHORT

- Made in Europe
- Used on Maypole Type Approved trailer boards
- Bulbs not included
- Horizontal orientation



Display Pack	Bulk Pack	Stop	Tail	Indicator	Reflector	No. Plate	Reverse	Fog	Voltage	Connection	Mount	
-	MP8303BL	✓	✓	✓	✓	✓	✓	✓	12V	Spade	Holes	
-	MP8303BR	✓	✓	✓	✓	✓	✓	✓	12V	Spade	Holes	
-	MP83035BL	Spare Lens for MP8303BL										
-	MP83035BR	Spare Lens for MP8303BR										

Bulb Combination Lamps

RECTANGULAR COMBINATION LAMP - SLIM LINE



- Made in Europe
- IP56
- Bulbs not included
- Available for use on trailer boards

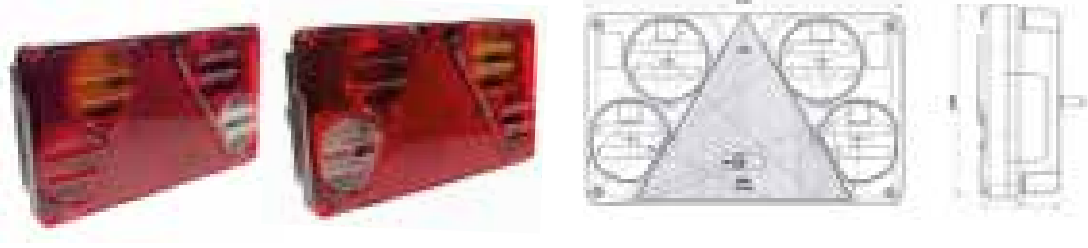

Display Pack	Bulk Pack	Stop	Tail	Indicator	Reflector	No. Plate	Reverse	Fog	Voltage	Connection	Mount	
-	MP825BL	✓	✓	✓	✓	✓	✓	✓	12/24v	Spade	Holes	
-	MP825BR	✓	✓	✓	✓	✓	✓	✓	12/24v	Spade	Holes	
-	MP8252BL	Spare Lens for MP825BL										
-	MP8252BR	Spare Lens for MP825BR										

RECTANGULAR COMBINATION LAMP - COMMERCIAL

- Plastic base
- Horizontal and vertical orientation
- Robust construction

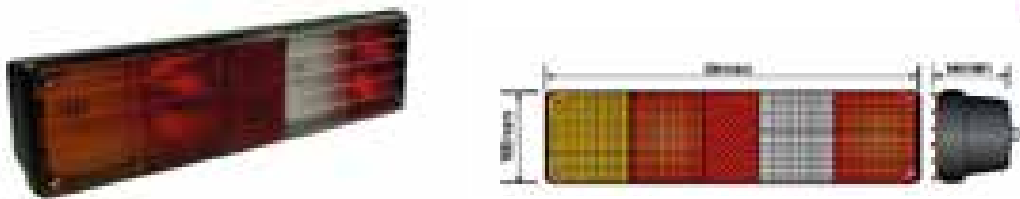

Display Pack	Bulk Pack	Stop	Tail	Indicator	Reflector	No. Plate	Reverse	Fog	Voltage	Connection	Mount
-	MP8201L	✓	✓	✓	✓		✓	✓	12V	Spade	Stud
-	MP8201R	✓	✓	✓	✓		✓	✓	12V	Spade	Stud

COMBINATION LAMP - (2900) WITH FOG



- Made in Europe
- Vertical orientation
- Bulbs included

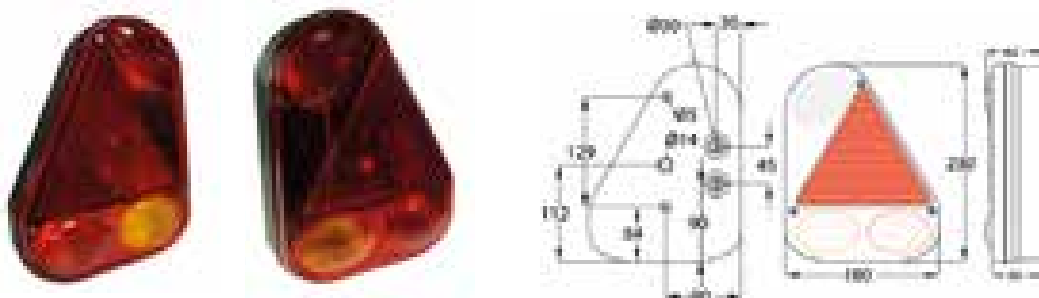

Display Pack	Bulk Pack	Stop	Tail	Indicator	Reflector	No. Plate	Reverse	Fog	Voltage	Connection	Mount	
-	MP770BL	✓	✓	✓	✓			✓	12V	Spade	Holes	
-	MP770BR	✓	✓	✓	✓			✓	12V	Spade	Holes	
-	MP771BL	Spare Lens for MP770BL										
-	MP771BR	Spare Lens for MP770BR										

Bulb Combination Lamps

COMBINATION LAMP - (2900) WITH REVERSE



- Made in Europe
- Vertical orientation
- Bulbs included

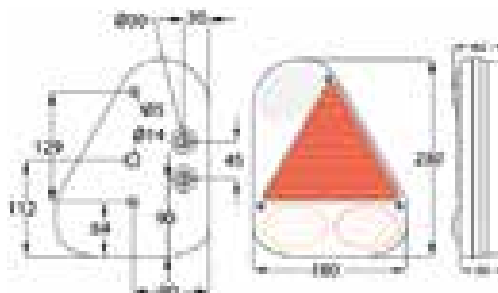

Display Pack	Bulk Pack	Stop	Tail	Indicator	Reflector	No. Plate	Reverse	Fog	Voltage	Connection	Mount	
-	MP7701BL	✓	✓	✓	✓		✓		12V	Spade	Holes	
-	MP7701BR	✓	✓	✓	✓		✓		12V	Spade	Holes	
-	MP7710BL	Spare Lens for MP7701BL										

HORIZONTAL COMBINATION LAMP



- Replacement lamp for M-Way Foxhound and Nighthawk cycle carriers
- Bulbs not included

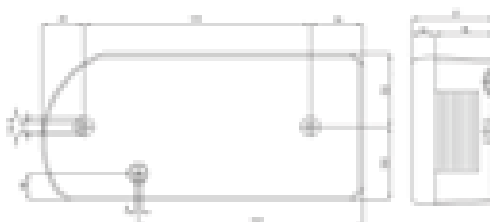
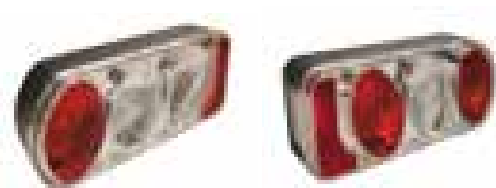

Display Pack	Bulk Pack	Stop	Tail	Indicator	Reflector	No. Plate	Reverse	Fog	Voltage	Connection	Mount
-	MP8583BL	✓	✓	✓	✓	✓	✓		12V	Cable entry	2xM5 Studs
-	MP8583BR	✓	✓	✓	✓	✓		✓	12V	Cable entry	2xM5 Studs

HORIZONTAL COMBINATION LAMP



- Replacement lamp for M-Way Seagull and Alphard cycle carriers
- Bulbs not included

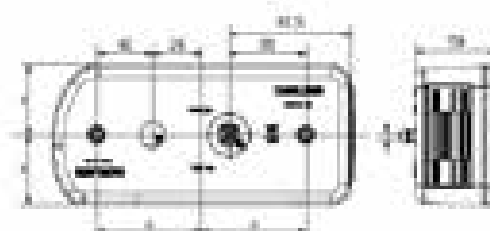

Display Pack	Bulk Pack	Stop	Tail	Indicator	Reflector	No. Plate	Reverse	Fog	Voltage	Connection	Mount
-	MP8588BL	✓	✓	✓	✓	✓	✓		12V	Cable entry	2xM5 Studs
-	MP8588BR	✓	✓	✓	✓	✓		✓	12V	Cable entry	2xM5 Studs

Bulb Fog Lamps

Bulb Squircular Combination Lamps

SQUIRCULAR COMBINATION LAMP - (L12.01.12V)



- Modular design
- Horizontal and vertical orientation
- Bulbs included
- Used on plant machinery

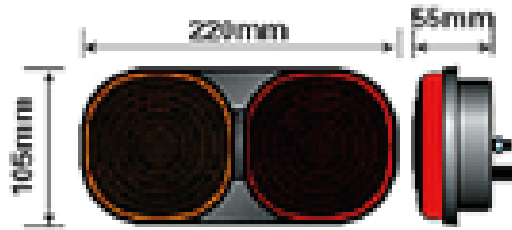

Display Pack	Bulk Pack	Stop	Tail	Indicator	Reflector	No. Plate	Reverse	Fog	Voltage	Connection	Mount
-	MP8612B	✓	✓	✓					12V	Spade	Holes

SQUIRCULAR COMBINATION LAMP - (L13.01.12V)



- 3 function modular design
- Horizontal and vertical orientation
- Bulbs included

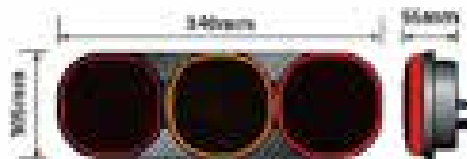

Display Pack	Bulk Pack	Stop	Tail	Indicator	Reflector	No. Plate	Reverse	Fog	Voltage	Connection	Mount
-	MP8622B	✓	✓	✓				✓	12V	Spade	Holes

Bulb Fog Lamps

FOG LAMP - BUDGET



- Used on Maypole trailer boards
- Surface mount
- Bulb included

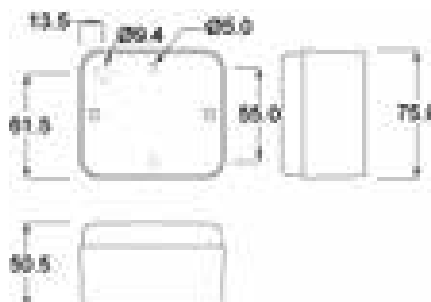

Display Pack	Bulk Pack	Voltage	Connection	Mount
MP22	MP22B	12V	Spade	Holes
-	MP28B	Spare Lens for MP22		

Bulb Reverse Lamps

FOG LAMP - WITH MOUNTING BRACKET

- Bulb included 1 x 382
- Includes mounting bracket

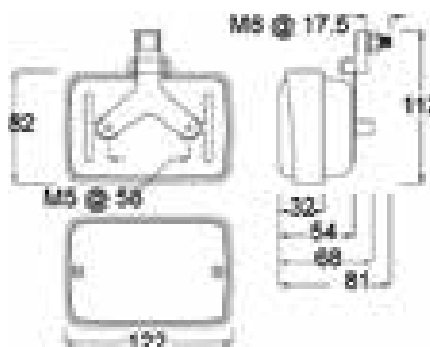

Display Pack	Bulk Pack	Voltage	Connection	Mount
MP845	MP845B	12V	Spade	Bracket

Bulb Reverse Lamps

REVERSE LAMP - (FR.30.001)

- Made in Europe
- Surface mounted
- Used on MP263 trailer boards
- Bulb included

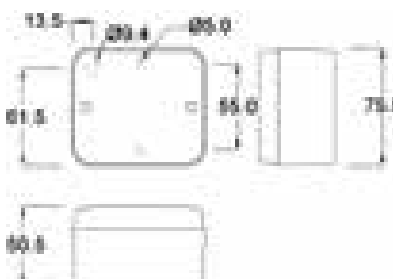

Display Pack	Bulk Pack	Voltage	Connection	Mount
-	MP60B	12V	Spade	Holes

REVERSE LAMP - WITH MOUNTING BRACKET

- Bulb included 1 x 382
- Includes mounting bracket

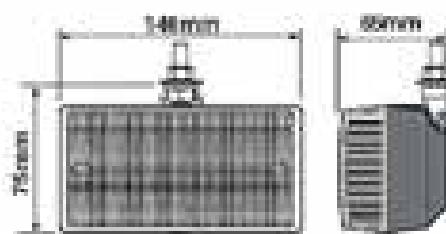

Display Pack	Bulk Pack	Voltage	Connection	Mount
MP846	MP846B	12V	Spade	Bracket

Bulb Number Plate Lamps

Bulb Number Plate Lamps

NUMBER PLATE LAMP - WITH STUDS

- Great value number plate lamp
- Includes studs
- Bulb included



Display Pack	Bulk Pack	Voltage	Connection	Mount
MP90	MP90B	12V	Hole	Studs

NUMBER PLATE LAMP - CHROME FINISH

- Chromed finish
- Includes 1 x 245 bulb (MP7795)

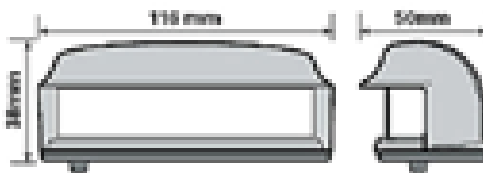

Display Pack	Bulk Pack	Voltage	Connection	Mount
MP883	MP883B	12V	Spade	Holes

NUMBER PLATE LAMP - (867)

- Includes 1 x 245 bulb (MP7795)

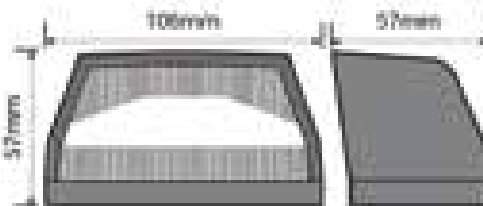

Display Pack	Bulk Pack	Voltage	Connection	Mount
MP33	MP33B	12V	Spade	Holes

Bulb Number Plate Lamps

NUMBER PLATE LAMP - (868)



■ Includes 1 x 239 bulb (MP7799)

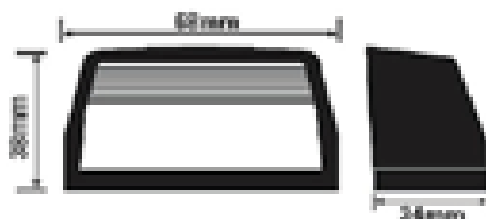

Display Pack	Bulk Pack	Voltage	Connection	Mount
MP982	MP982B	12V	Spade	Holes

NUMBER PLATE LAMP - (FT.18.001)



■ Made in Europe ■ Includes 1 x 239 bulb (MP7799)



Display Pack	Bulk Pack	Voltage	Connection	Mount
MP980	MP980B	12V	Spade	Holes

Caravan Replacement Lamps

WRAP AROUND CARAVAN LAMP - (9300)



■ Caravan replacement lamp ■ Bulbs included 3 x 382 & 1 x 380

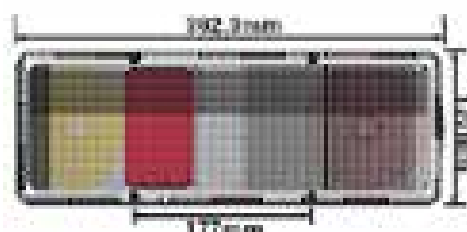
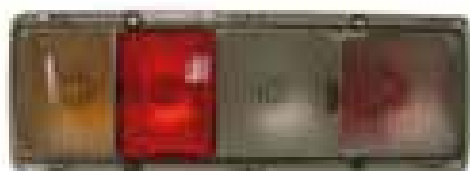

Display Pack	Bulk Pack	Voltage	Connection	Mount
MP379	-	12V	-	Screws

Truck-Lite is a global leader in the design and manufacture of lighting systems servicing the automotive and commercial vehicles industry. Maypole are now working in partnership with Truck-Lite to offer their range of quality rubber based lamps, many suitable for Ifor Williams trailers.

Marker Lamps

M554 MARKER LAMP



- 1 x R5W bulb

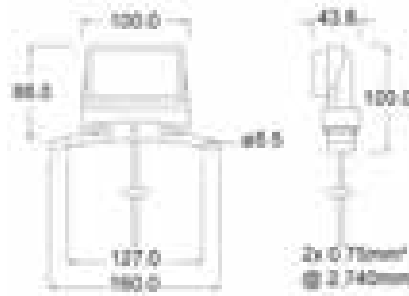

Bulk Pack	Truck-Lite Part No.	Position	Voltage	Connection	Orientation	Box Qty
TR55401	554/01/09	Front Clear	12V	Cable Entry	Horiz. & Vert.	-

M50 MARKER LAMP



- 1 x R5W bulb
- Metal fixing plate

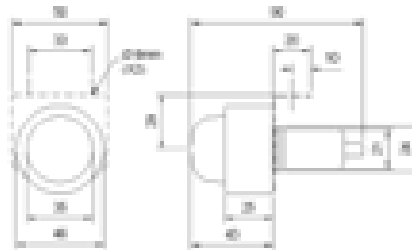

Bulk Pack	Truck-Lite Part No.	Position	Voltage	Connection	Orientation	Box Qty
TR5001	50/01/00	Front Clear	12V	Cable Entry	Horiz. & Vert.	-

M122 MARKER LAMP



- 1 x R15/5W bulb

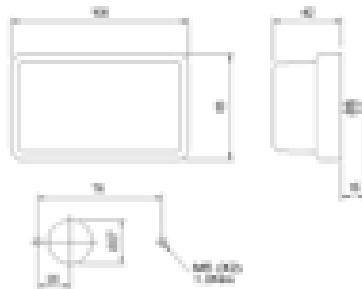

Bulk Pack	Truck-Lite Part No.	Position	Voltage	Connection	Orientation	Box Qty
TR12201	122/01/00	Front Clear	12V	Cable Entry	Horiz. & Vert.	-
TR3988	3988	Spare Lens for 122/01/00				

Combination Lamps

M64 RECTANGULAR COMBINATION LAMP



■ 1 x 21W bulb



Bulk Pack	Truck-Lite Part No.	Stop	Tail	Indicator	Reflector	No. Plate	Reverse	Fog	Voltage	Connection	Orientation	
TR6401	64/01/11	✓	✓	✓					12V	Cable Entry	Horizontal	
TR1510	1510A	Spare Lens for 64/01/11										

M340 RECTANGULAR COMBINATION LAMP



■ 2 x P21W bulb



Bulk Pack	Truck-Lite Part No.	Stop	Tail	Indicator	Reflector	No. Plate	Reverse	Fog	Voltage	Connection	Orientation	
TR34001	340/01/00	✓	✓	✓					12V	Cable Entry	Horizontal	
TR6268	6268	Spare Lens for 340/01/00										

THQ/04/00 RECTANGULAR COMBINATION LAMP - RIGHT HAND FOG



■ 1 x 21W bulb



Bulk Pack	Truck-Lite Part No.	Stop	Tail	Indicator	Reflector	No. Plate	Reverse	Fog	Voltage	Connection	Orientation
TRHQ400	THQ/04/00	✓	✓	✓	✓	✓		✓	12V	Cable Entry	Horizontal

THQ/04/01 RECTANGULAR COMBINATION LAMP - LEFT HAND REVERSE

■ 1 x P21W bulb & 1 x P5W bulb

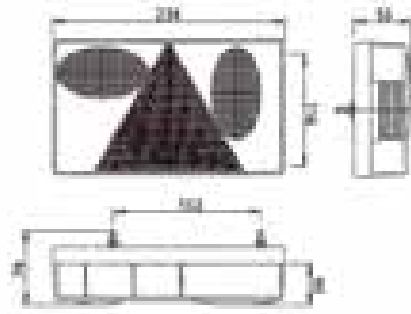

Bulk Pack	Truck-Lite Part No.	Stop	Tail	Indicator	Reflector	No. Plate	Reverse	Fog	Voltage	Connection	Orientation
TRHQ0401	THQ/04/11	✓	✓	✓	✓	✓	✓		12V	Cable Entry	Horizontal

THQ/04/02 RECTANGULAR COMBINATION LAMP - RIGHT HAND REVERSE

■ 1 x P21W bulb & 1 x P5W bulb

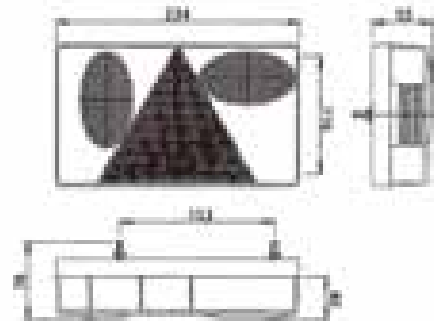

Bulk Pack	Truck-Lite Part No.	Stop	Tail	Indicator	Reflector	No. Plate	Reverse	Fog	Voltage	Connection	Orientation
TRHQ0402	THQ/04/02	✓	✓	✓	✓	✓	✓		12V	Cable Entry	Horizontal

SPARE LENS FOR 377/01

■ Lens suitable for Ifor Williams lamps PO6785 and PO6786

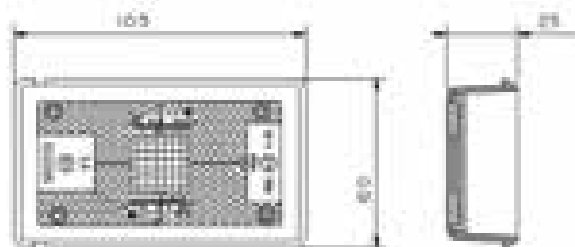

Bulk Pack	Truck-Lite Part No.	
TR81951	81951	Spare Lens for 377/01

M313 MODULAR COMBINATION LAMP



- 2346A - P25/1 SCC 12V/21W bulb
- 3294A - P25/1 SCC 24V/21W HD bulb

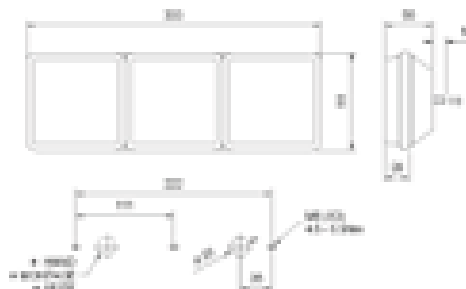

Bulk Pack	Truck-Lite Part No.	Stop	Tail	Indicator	Reflector	No. Plate	Reverse	Fog	Voltage	Connection	Orientation
TR31301	313/01/00	✓	✓	✓				✓	12V	Cable Entry	Horiz. & Vert.

M312 MODULAR COMBINATION LAMP



- 2346A - P25/1 SCC 12V/21W bulb
- 3294A - P25/1 SCC 24V/21W HD bulb

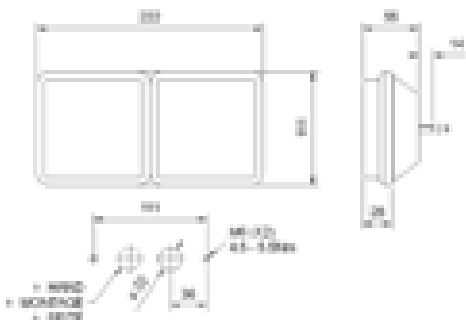

Bulk Pack	Truck-Lite Part No.	Stop	Tail	Indicator	Reflector	No. Plate	Reverse	Fog	Voltage	Connection	Orientation
TR31201	312/01/00	✓	✓	✓					12V	Cable Entry	Horiz. & Vert.

M312 MODULAR COMBINATION LAMP LENSES

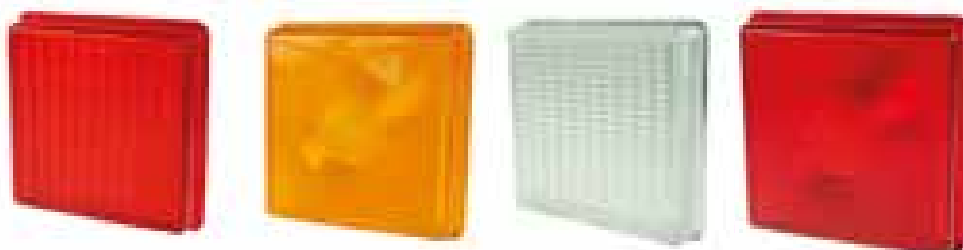

Bulk Pack	Truck-Lite Part No.	Stop	Tail	Indicator	Reverse	Fog
TR3809	3809A					✓
TR4851	4851			✓		
TR5366	5366				✓	
TR5428	5428	✓	✓			

Fog Lamp

M311 FOG LAMP



■ 1 x P21W bulb

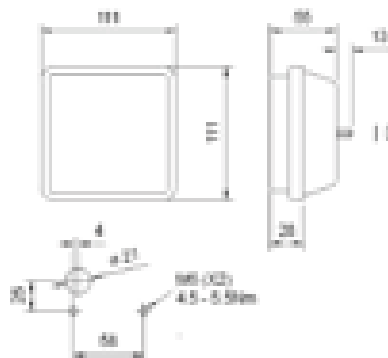

Bulk Pack	Truck-Lite Part No.	Voltage	Connection	Orientation
TR31101	311/01/00	12V	2m cable	Horiz. & Vert.
TR3809	3809	Spare Lens for 313/01 & 311/01		

Number Plate Lamp

M133 NUMBER PLATE LAMP



■ 1 x R10W bulb

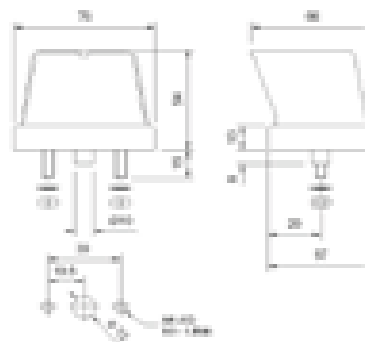

Bulk Pack	Truck-Lite Part No.	Voltage	Connection	Orientation
TR13301	133/01/00	12V	Cable Entry	Horiz. & Vert.



We manufacture Trailer Lighting Boards

We are the leading and indeed the only major trailer board manufacturer in the UK. Yes, our competitors sell standard boards, but we are the *specialists*.

We offer everything; a complete bespoke service such as a detachable board for a 10ft boat trailer, to a basic cycle carrier board.

We have it or we will manufacture it to your specification.

Benefits of dealing with Maypole

- Manufactured in Birmingham, UK
- Design and technical support
- Technical drawings created for all boards
- Type Approval advice and support
- Lamp approval documentation available
- Board/lighting installation available
- Low minimum order quantities (typically 10)
- Unique options like our profiled end caps, allowing marker, reflector or stalk lamp mount
- Massive range of LED & Bulb options, including 24v and reverse functionality
- Wide range of connectivity 7, 8 Pin, 24N etc
- Power take off for marker lamps etc.
- Specialist and bespoke 'builds' undertaken
- Computerised CNC drilling to meet demanding Type Approval positioning requirements
- Compatible to integrated harness option. Ideal for boat trailers

Talk to our technical team on 0121 270 4301

Planking

- Standard
- Heavy duty
- Any length up to 8ft



End Caps

- White / Standard
- Profile end cap (HD only)
- Outline markers & reflector option

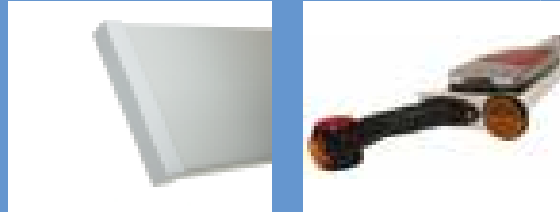

Lights - A comprehensive range of E Approved 12 & 24v filament & LED lamps

- Full function combination lamps
- LED options
- 12v LED combination lamps
- 12/24 varivolt LED combination lamps



- Marker lamps
- LED option
- Sidemarkers
- LED option



- Reverse lamps
- LED reverse lamps
- Fog lamps
- LED fog lamps



- Reverse multi-function combination
- Number plate
- LED option



Reflectors - A comprehensive range of E Approved reflex reflectors

- Reflectors
- E Approved
- Cycle carrier reflector

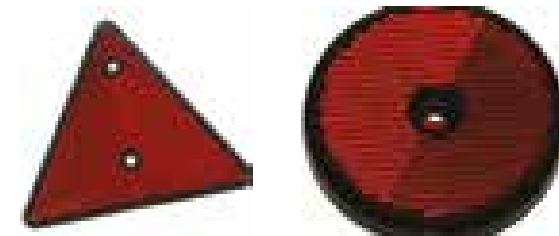

Cable - Automotive cable with various current and voltage capacities

- 7 & 13 Pin wiring
- Any lengths up to 14m
- 7 and 8 core
- 6, 7 or 8 core

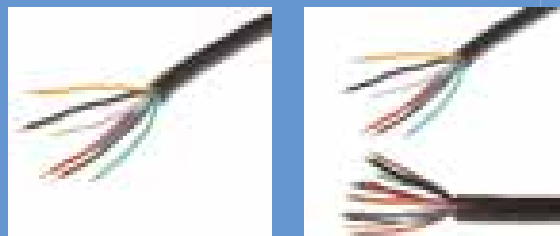

Connectivity

- 7 or 8 pin plugs
- 12 or 24 volt
- 24N option
- Plastic or aluminium
- Power take off for marker lamps



- Sockets
- Compatible for use with extension leads & harness systems
- Allowing easy removal e.g. boat trailers



Trailer Lighting Pods

Magnetic Lighting Pods

12V LED POD WITH STRAIGHT CABLE

- Ideal for agricultural applications
- Powerful integrated magnets for quick and easy attachment
- Waterproof connection allows lamps to be detached
- 2 x E Approved LED combination lamps (Stop/Tail/Indicator/Number Plate)
- Straight connecting cable and 7 pin plug
- Supplied in a blister pack with colour insert



Cable Length	Connecting Cable Length	Box Qty	Code
6m	1.8m	6	MP44954
10m	3m	6	MP44964

12V LED POD WITH STRAIGHT CABLE & TRIANGLES

- Ideal for agricultural applications
- Powerful magnets for quick and easy attachment
- 2 x E Approved LED combination lamps (Stop/Tail/Indicator/Number Plate)
- 2 x E Approved triangles on steel mounting plates
- Curly connecting cable and 7 pin plug
- Supplied in a blister pack with colour insert



Cable Length	Connecting Cable Length	Box Qty	Code
6m	1.8m	6	MP44952
10m	3m	6	MP44962

12V BULB POD WITH TRIANGLE & CURLY CABLE

- Ideal for agricultural applications
- Fitted with powerful magnets for quick and easy attachment
- 2 x bulb combination lamps (Stop/Tail/Indicator/Number Plate)
- 2 x triangles on steel mounting plates
- Extendible curly connecting cable and 7 pin plug
- Supplied in a clip bag and insert



Cable Length	Connecting Cable Length	Box Qty	Code
6m	1.8m	5	MP4412
10m	3m	5	MP4422

Trailer Lighting Pods

12V BULB POD WITH CURLY CABLE

- Ideal for agricultural applications
- Fitted with powerful magnets for quick and easy attachment
- 2 x bulb combination lamps (Stop/Tail/Indicator/Number Plate)
- Extendible curly connecting cable and 7 pin plug
- Supplied in a clip bag and insert

Cable Length	Connecting Cable Length	Box Qty	Code
6m	1.8m	5	MP4414
10m	3m	5	MP4424



12V BULB POD WITH TRIANGLE & STRAIGHT CABLE

- Ideal for agricultural applications
- Fitted with powerful magnets for quick and easy attachment
- 2 x E Approved bulb combination lamps (Stop/Tail/Indicator/Number Plate)
- 2 x E Approved triangles on steel mounting plates
- Straight connecting cable and 7 pin plug
- Supplied in a blister pack with colour insert

Cable Length	Connecting Cable Length	Box Qty	Code
6m	1.8m	5	MP44912
10m	3m	5	MP44922



12V BULB POD WITH STRAIGHT CABLE

- Ideal for agricultural applications
- Fitted with powerful magnets for quick and easy attachment
- 2 x E Approved bulb combination lamps (Stop/Tail/Indicator/Number Plate)
- Straight connecting cable and 7 pin plug
- Supplied in a blister pack with colour insert

Cable Length	Connecting Cable Length	Box Qty	Code
6m	1.8m	5	MP44914
10m	3m	5	MP44924



Lighting Pods

12V LIGHTING POD WITH WHITE PLATES

- Ideal for agricultural applications
- White durable plastic POD plates with fixing holes
- 2 x bulb combination lamps (Stop/Tail/Indicator/Number Plate)
- 2 x E Approved triangles
- Curly connecting cable and 7 pin plug
- Supplied in a clip bag with colour insert

Cable Length	Connecting Cable Length	Box Qty	Code
6m	1.8m	5	MP441
10m	3m	5	MP442



Trailer Lighting Boards

Trailer Lighting Boards

STANDARD LED LAMPS - 12V

■ Standard Ex-Stock

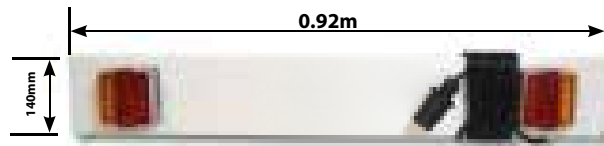

Code	Board Length	Cable Length	Lamps	Reflectors	Qty
MP251PLED	0.92m (approx. 3')	4m	MP8893B/8899B	-	4

LED LAMPS PLUS TRIANGLES - 12V

■ Standard Ex-Stock

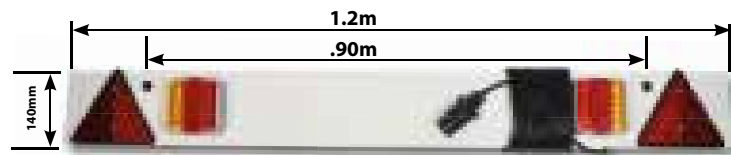

Code	Board Length	Cable Length	Lamps	Reflectors	Qty
MP253PLED	1.2m (approx. 4')	5m	MP8893B/8899B	MP16B x 2	4
MP253P4F7MLED	1.2m (approx. 4')	7m	MP8893B/8899B	MP16B x 2	10
MP253P4F10MLED	1.2m (approx. 4')	10m	MP8893B/8899B	MP16B x 2	10
MP254PLED*	1.2m (approx. 4')	6m	MP8893B/8899B	MP16B x 2	10

LED LAMPS WITH FOG - 12V

■ Special (10 day lead time*)



Code	Board Length	Cable Length	Lamps	Reflectors	Fog	Qty
MP256PLED	1.35m (approx. 4'6")	6m	MP8893B/8899B	MP16B x 2	MP863B	10
MP256P6P10MLED	1.8m (approx. 6')	10m	MP8893B/8899B	MP16B x 2	MP863B	10

LED COMBINATION LAMPS

■ Special (10 day lead time*)

■ Manufactured to meet your Type Approval requirements

■ Heavy duty board

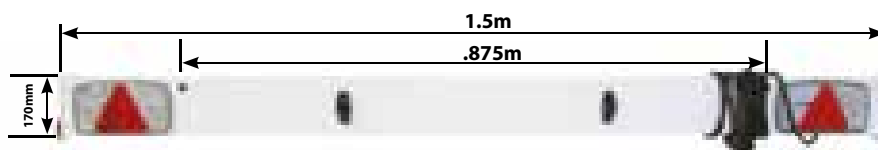

Code	Board Length	Cable Length	Lamps	Reflectors	No. Plate Lamps	Qty
MP264P5F10M	1.5m (approx. 5')	10m	MP8603BL/BR	MP155SSB x 2	MP8228B x 2	5

*Lead time may vary due to demand. Dimensions have a tolerance +/-5mm

Trailer Lighting Boards

LED VARIVOLT LAMPS - 12/24V

■ Standard Ex-stock

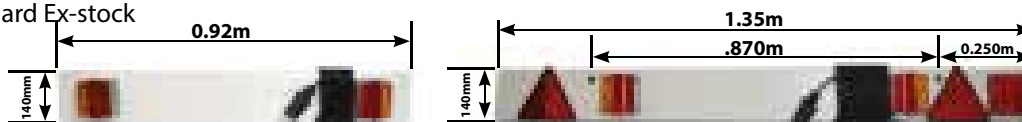

Code	Board Length	Cable Length	Lamps	Reflectors	Fog	Qty
MP271PLED	0.92m (approx. 3')	4m	MP8903B/8909B	-	-	4
MP273PLED	1.2m (approx. 4')	5m	MP8903B/8909B	MP16B x 2	-	4
MP274PLED	1.2m (approx. 4')	6m	MP8903B/8909B	MP16B x 2	-	4
MP276PLED	1.35m (approx. 4')	6m	MP8903B/8909B	MP16B x 2	MP8631B	4

LED VARIVOLT LAMPS

■ Special (10 day lead time*)



Code	Board Length	Cable Length	Lamps	Reflectors	No. Plate Lamps	Qty
MP255PLED(V)*	1.35m (approx. 4'6")	5m	MP861B x 2	MP16B x 2	MP8228B	4

STANDARD

■ Standard Ex-Stock

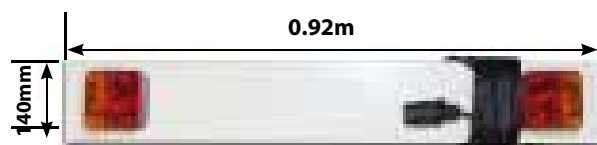

Code	Board Length	Cable Length	Lamps	Reflectors	Qty
MP251P3F3M	0.92m (approx. 3')	3m	MP17B x 2	-	10
MP251P	0.92m (approx. 3')	4m	MP17B x 2	-	10

■ Special (10 day lead time*) ■ Other specifications available upon request

Code	Board Length	Cable Length	Lamps	Reflectors	Qty
MP251P3F5M*	0.92m (approx. 3')	5m	MP17B x 2	-	10
MP251P3F6M*	0.92m (approx. 3')	6m	MP17B x 2	-	10
MP251P3F7M*	0.92m (approx. 3')	7m	MP17B x 2	-	10

STANDARD PLUS TRIANGLE

■ Standard Ex-Stock



Code	Board Length	Cable Length	Lamps	Reflectors	Qty
MP2524M	1.2m (approx. 4')	4m	MP17B x 2	MP16B x 2	10
MP252P	1.2m (approx. 4')	5m	MP17B x 2	MP16B x 2	10

■ Special (10 day lead time*) ■ Other specifications available upon request

Code	Board Length	Cable Length	Lamps	Reflectors	Qty
MP252P(13P)*	1.2m (approx. 4')	5m	MP17B x 2	MP16B x 2	10

*Lead time may vary due to demand. Dimensions have a tolerance +/-5mm

Trailer Lighting Boards

STANDARD PLUS TRIANGLE AND MOUNTING HOLES

■ Standard Ex-Stock

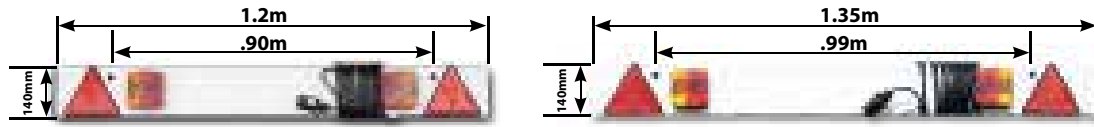

Code	Board Length	Cable Length	Lamps	Reflectors	Qty
MP253P	1.2m (approx. 4')	5m	MP17B x 2	MP16B x 2	10
MP253P4F7M	1.2m (approx. 4')	7m	MP17B x 2	MP16B x 2	10
MP253P4F8M	1.2m (approx. 4')	8m	MP17B x 2	MP16B x 2	10
MP253P4F10M	1.2m (approx. 4')	10m	MP17B x 2	MP16B x 2	10
MP254P	1.2m (approx. 4')	6m	MP17B x 2	MP16B x 2	10
MP257P	1.35m (approx. 4'6")	6m	MP17B x 2	MP16B x 2	10

■ Special (10 day lead time*)

■ Other specifications available upon request

Code	Board Length	Cable Length	Lamps	Reflectors	Qty
MP253P4.5F10M*	1.35m (approx. 4'6")	10m	MP17B x 2	MP16B x 2	10
MP253P5F10M*	1.5m (approx. 5')	10m	MP17B x 2	MP16B x 2	10
MP253P6F10M*	1.8m (approx. 6')	10m	MP17B x 2	MP16B x 2	10

SINGLE AND TWIN FOG

■ Standard Ex-Stock

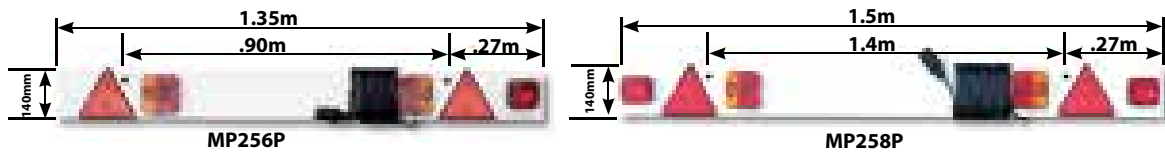

Code	Board Length	Cable Length	Lamps	Reflectors	Fog	Qty
MP256P4F6M	1.2m (approx. 4')	6m	MP17B x 2	MP16B x 2	MP22B	10
MP256P	1.35m (approx. 4'6")	6m	MP17B x 2	MP16B x 2	MP22B	10
MP256P6F10M	1.8m (approx. 6')	10m	MP17B x 2	MP16B x 2	MP22B	10
MP258P	1.53m (approx. 5')	6m	MP17B x 2	MP16B x 2	MP22B	10

■ Special (10 day lead time*)

■ Other specifications available upon request

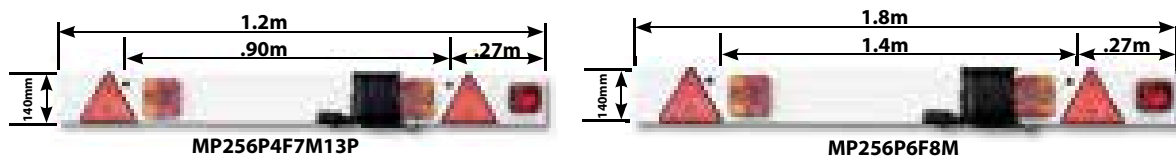

Code	Board Length	Cable Length	Lamps	Reflectors	Fog	Qty
MP256P4F7M13P*	1.2m (approx. 4')	7m	MP17B x 2	MP16B x 2	MP22B	10
MP256P4.5F7M*	1.35m (approx. 4'6")	7m	MP17B x 2	MP16B x 2	MP22B	10
MP256P4.5F10M*	1.35m (approx. 4'6")	10m	MP17B x 2	MP16B x 2	MP22B	10
MP256P5F10M*	1.5m (approx. 5')	10m	MP17B x 2	MP16B x 2	MP22B	10
MP256P6F8M*	1.8m (approx. 6')	8m	MP17B x 2	MP16B x 2	MP22B	10

*Lead time may vary due to demand. Dimensions have a tolerance +/-10mm

Trailer Lighting Boards

FOG & REVERSE

- Special (10 day lead time*)
- Other specifications available upon request



MP263P5F10M

Code	Board Length	Cable Length	Lamps	Reflectors	Fog	Reverse	Qty
MP263P*	1.8m (approx. 6')	6m	MP17B x 2	MP16B x 2	MP22B	MP60B	10
MP263P5F10M*	1.5m (approx. 5')	10m	MP17B x 2	MP16B x 2	MP22B	MP60B	10
MP263P6F10M*	1.8m (approx. 6')	10m	MP17B x 2	MP16B x 2	MP22B	MP60B	10

7 FUNCTIONS REVERSE COMBINATION BOARD

- Special (10 day lead time*)
- Heavy duty board



Code	Board Length	Cable Length	Lamps	Reflectors	Outline Markers	No. Plate Lamps	Qty
MP261P6F10M*	1.8m (approx. 6')	10m	MP8303BL/BR	MP155SSB x 2	MP8765B x 2	MP33B x 2	10

CYCLE CARRIER LIGHTING BOARDS

- Standard Ex-Stock

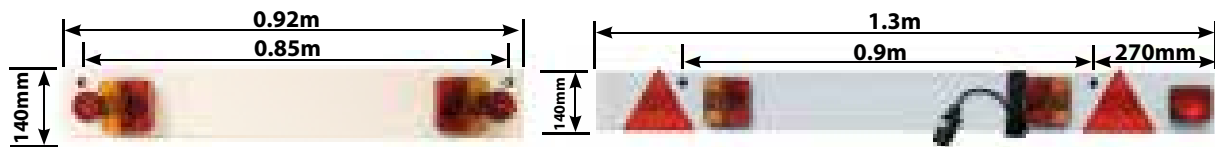

Code	Board Length	Cable Length	Lamps	Reflectors	Qty
MP8551P	0.92m (approx. 3')	2m	MP17B x 2	MP854B x 2	10

- Special (10 day lead time*)

Code	Board Length	Cable Length	Lamps	Reflectors	Fog	Qty
MP955P*	1.35m (approx. 4'6")	2m	MP17B x 2	MP854B x 2	MP22B	10

RECOVERY BOARD

- Fold-away boards are ideal for recovery vehicles
- Compact for storage on a van or recovery truck
- Storage bag available
- Special (10 day lead time*)
- Features hinge, 13 pin socket, straps etc.



Code	Board Length	Cable Length	Lamps	Reflectors	Qty
MP268F*	1.5m (approx. 5')	8m	MP8603BL/BR	MP155SSB x 2	1

*Lead time may vary due to demand. Dimensions have a tolerance +/-5mm

Reflectors

Replacement Bulbs

BULBS



MP7797

MP7799

MP7760

MP7762

Bulk Pack (per 10)	Ref No.	Power	Type	Cap
MP7797	207	12V 5W	Small	BA15s
MP7799	239	12V 5W	Festoon	SV8.5-8
MP7760	380	12V 21/5W	Standard	BA15d
MP7762	382	12V 21W	Standard	BA15s

Reflectors

REFLECTIVE TRAILER TRIANGLE

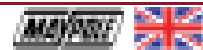

- 2 holes Ø 5.8mm for mounting the triangle
- Manufactured in the UK

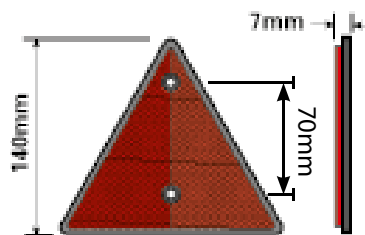

Display Pack	Bulk Pack	Bulk Pack Qty
MP16 (Pair)	MP16B	10

REFLECTIVE TRAILER TRIANGLE - WHITE SURROUND



- 2 holes Ø 5.8mm for mounting the triangle
- Manufactured in the UK

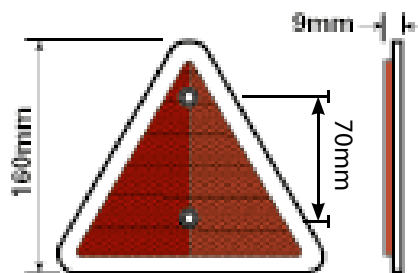

Display Pack	Bulk Pack	Bulk Pack Qty
MP18 (Pair)	MP18B	10

Reflectors

CARAVAN REPLACEMENT REFLECTORS - OVAL



■ Self adhesive

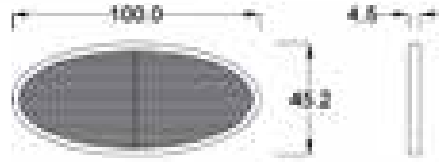

	Display Pack	Bulk Pack	Bulk Pack Qty
Clear	MP8561	MP8561B	10
Amber	MP8563	MP8563B	10
Red	MP8562	MP8563B	10

REFLEX REFLECTORS - MOUNTING HOLES



■ Horizontal mount



	Display Pack	Bulk Pack	Bulk Pack Qty
Clear	-	MP8856B	50
Amber	-	MP8858B	50
Red	-	MP8857B	50

REFLEX REFLECTORS - MOUNTING HOLES



■ Horizontal and vertical mount

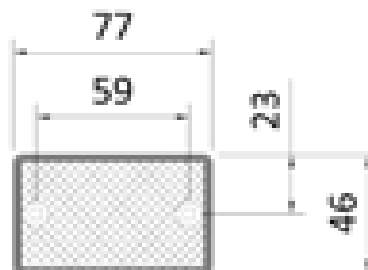

	Display Pack	Bulk Pack	Bulk Pack Qty
Clear	MP8721 (Pair)	MP8721B	50
Amber	MP8723 (Pair)	MP8723B	50
Red	MP8722 (Pair)	MP8722B	50

Reflectors

REFLEX REFLECTORS - SELF ADHESIVE

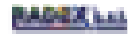

■ Horizontal mount

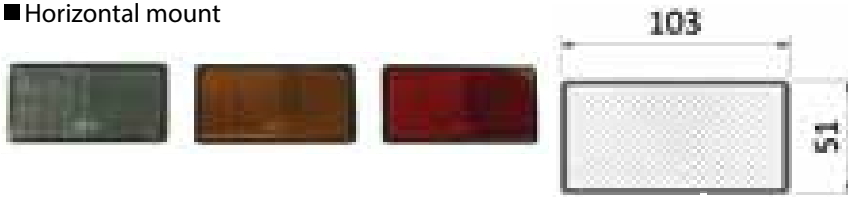

	Display Pack	Bulk Pack	Bulk Pack Qty
Clear	-	MP8856SSB	50
Amber	-	MP8858SSB	50
Red	-	MP8857SSB	50

REFLEX REFLECTORS - SELF ADHESIVE



■ Horizontal and vertical mount



	Display Pack	Bulk Pack	Bulk Pack Qty
Clear	MP8721SS (Pair)	MP8721SSB	50
Amber	MP8723SS (Pair)	MP8723SSB	50
Red	MP8722SS (Pair)	MP8722SSB	50

REFLEX REFLECTORS - WITH MOUNTING HOLE

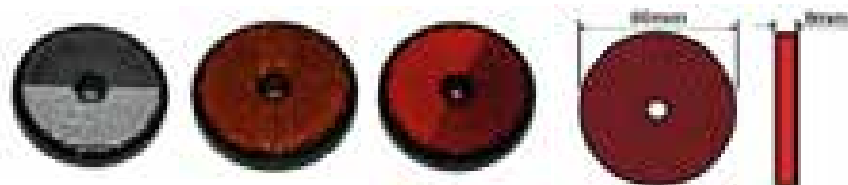

	Display Pack	Bulk Pack	Bulk Pack Qty
Clear	MP162 (Pair)	MP162B	50
Amber	MP155 (Pair)	MP155B	50
Red	MP854 (Pair)	MP854B	50

REFLEX REFLECTORS - CIRCLE SELF ADHESIVE



	Display Pack	Bulk Pack	Bulk Pack Qty
Clear	-	MP162SSB	50
Amber	-	MP155SSB	50
Red	-	MP854SSB	50
Bracket	-	MP1554B	50

Beacons



A comprehensive range of LED and halogen beacons. Suitable for a wide range of vehicles and applications

Beacons

LED Beacons

- Very low power consumption
- 3 selectable flash patterns; 360° rotating, single flash and high speed strobe
- Reverse polarity protection
- Operating temperature of -30°C to +50°C
- IP66
- 3 years warranty

12/24V MAGNETIC LED BEACON

- Cigar lighter adaptor with integrated flash mode selection switch
- Tested to 70mph
- R65 fully approved for highway use
- 2.5m curly cable

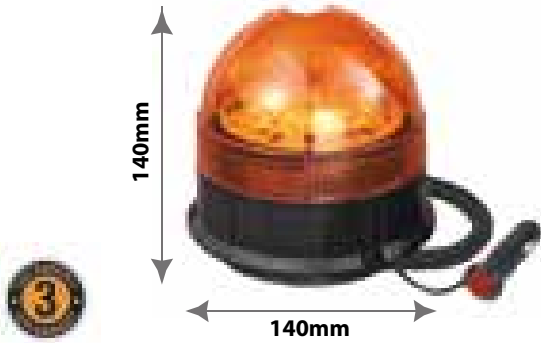

Display Pack	Voltage	LEDs	Connection	Mount
MP4100	12/24V	12x3W	Cigar Socket	Magnetic

12/24V 3 BOLT FIXING LED BEACON

- 3 fixings to suit M5 fixings on 124mm PCD

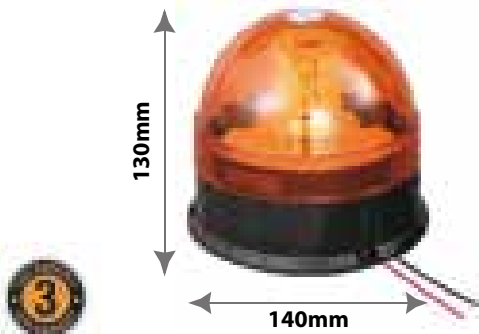

Display Pack	Voltage	LEDs	Connection	Mount
MP4090	12/24V	40x3W	Hard Wired	3 Bolt

12/24V MAGNETIC LED BEACON

- Cigar lighter adaptor with integrated mode selection switch
- Tested to 70mph
- 2.5m curly cable

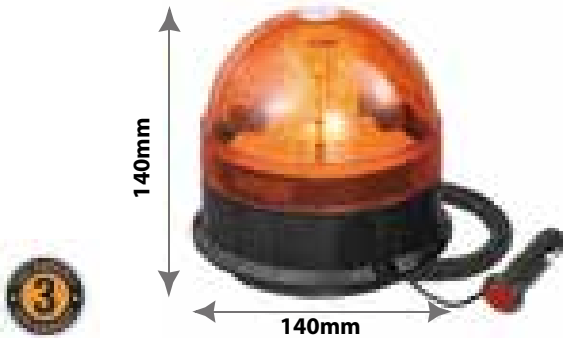

Display Pack	Voltage	LEDs	Connection	Mount
MP4091	12/24V	40x3W	Cigar Socket	Magnetic

Beacons

12/24V MAGNETIC LED BEACON WITH HELLA PLUG

■ 2 in 1 plug; will fit cigar & Hella sockets



Display Pack	Voltage	LEDs	Connection	Mount
MP40912	12/24V	40x3W	Cigar Socket / Hella Plug	Magnetic

12/24V SINGLE BOLT FIXING LED BEACON

■ M12 by 25mm bolt with M12.5 fixing



Display Pack	Voltage	LEDs	Connection	Mount
MP4092	12/24V	40x3W	Hard Wired	Single Bolt

12/24V FLEXI DIN POLE LED BEACON



Display Pack	Voltage	LEDs	Connection	Mount
MP4093	12/24V	40x3W	Hard Wired	Flexi DIN

Beacons

12/24V GREEN SINGLE BOLT FIXING LED BEACON

■ Green beacons are used to signal when a seatbelt is in use on plant hire equipment



Display Pack	Voltage	LEDs	Connection	Mount
MP40924	12/24V	40x3W	Hard Wired	Single Bolt

12/24V GREEN FLEXI DIN POLE LED BEACON

■ Green beacons are used to signal when a seatbelt is in use on plant hire equipment



Display Pack	Voltage	LEDs	Connection	Mount
MP40934	12/24V	40x3W	DIN Mount	Flexi DIN

SPARE LENSES FOR LED BEACONS



Colour	Display Pack	Box Qty
Green	MP4094	5
Orange	MP40945	5

Beacons

Halogen Beacons

- Gear driven motor for long life performance
- Reverse polarity protection
- IP66
- 3 years warranty
- Operating temperature of -30°C to +50°C
- R65 Fully approved for highway use
- Supplied with 1 x H1 55W 12V bulb & 1 x H1 70W 24V bulb

12/24V 3 BOLT FIXING HALOGEN BEACON

- 3 fixings to suit M5 fixings on 124mm PCD



Display Pack	Voltage	Connection	Mount
MP4080	12/24V	Hard Wired	3 Bolt

12/24V MAGNETIC HALOGEN BEACON

- Tested to 70mph
- 2.5m curly cable
- Cigar lighter with integrated flash pattern section switch

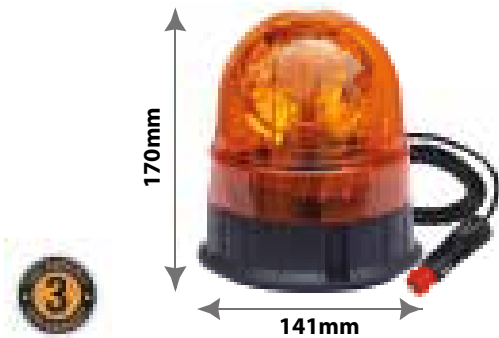

Display Pack	Voltage	Connection	Mount
MP4081	12/24V	Cigar Socket	Magnetic

12/24V SINGLE BOLT FIXING HALOGEN BEACON

- M12 by 25mm bolt with M12.5 fixing

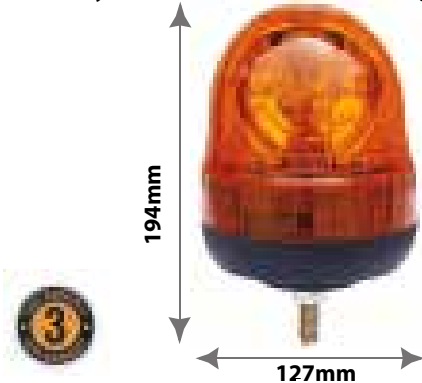

Display Pack	Voltage	Connection	Mount
MP4082	12/24V	Hard Wired	Single Bolt

Beacons

12/24V FLEXI DIN HOLE HALOGEN BEACON



Display Pack	Voltage	Connection	Mount
MP4083	12/24V	Hard Wired	Flexi DIN Pole

DIN Mounted Beacon Brackets

HORIZONTAL FLAT SURFACE BRACKET CONNECTOR

- Suitable for MP4083, MP4093 & MP40934
- Standard mount fits other manufacturer beacons

Bulk Pack
MP4440B

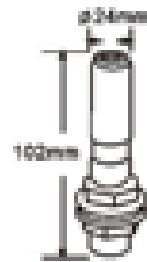

U-SHAPED VERTICAL SURFACE BRACKET CONNECTOR

- Suitable for MP4083, MP4093 and MP40934
- Standard mount fits other manufacturer beacons

Bulk Pack
MP4441B

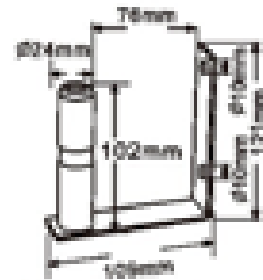

90° VERTICAL SURFACE BRACKET CONNECTOR

- Suitable for MP4083, MP4093 and MP40934
- Standard mount fits other manufacturer beacons

Bulk Pack
MP4442B

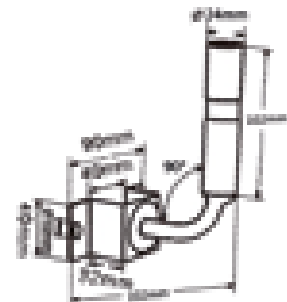

LED Strobes

LED Strobes

- Multiple flash patterns
- External surface mount
- 4mm mounting holes
- Aluminium housing
- Can be synchronised with other strobes of the same type
- Reverse polarity protection
- IP67

12/24V AMBER LED STROBE - 9W

- 71mm hole centres
- Suitable for use with mounting bracket MP4446B

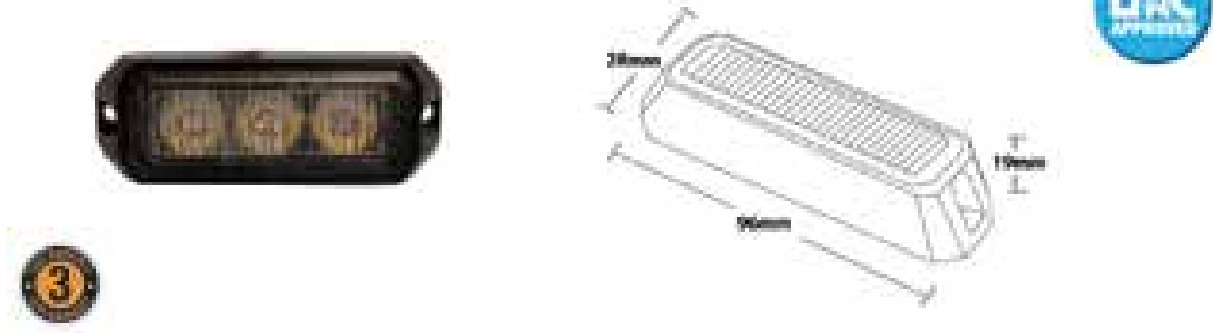

Display Pack	Bulk Pack	LEDs	Approval
MP4110	MP4110B	3x3W	R10

12/24V AMBER LED STROBE - 12W

- 88mm hole centres
- Suitable for use with mounting bracket MP4446B

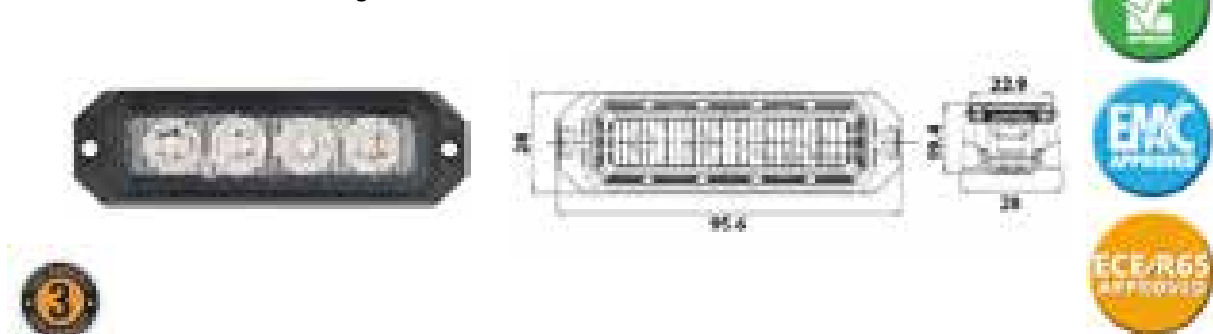

Display Pack	Bulk Pack	LEDs	Approval
MP4111	MP4111B	4x3W	R10/R65

12/24V AMBER LED STROBE - 9W

- 85mm hole centres
- Removable plastic cover
- Suitable for use with mounting bracket MP4446B

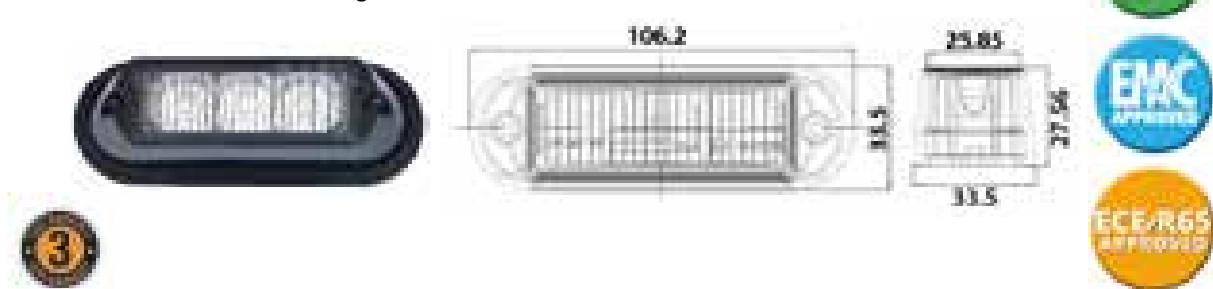

Display Pack	Bulk Pack	LEDs	Approval
MP4112	MP4112B	3x3W	R10/R65

LED Strobes

12/24V AMBER LED STROBE - 12W

- 111mm hole centres
- Removable plastic cover
- Suitable for use with mounting bracket MP4447B



Display Pack	Bulk Pack	LEDs	Approval
MP4113	MP4113B	4x3W	R10/R65

MOUNTING BRACKET FOR MP4110/4111/4112

- 12mm hole diameter

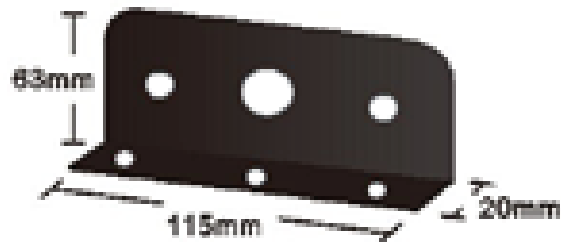

Bulk Pack
MP4446B

MOUNTING BRACKET FOR MP4113

- 12mm hole diameter

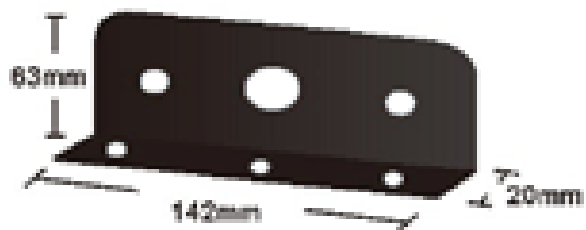

Bulk Pack
MP4447B

Work Lamps



- High intensity long life LEDs
- Daylight colour output of 6500K
- Waterproof and dustproof
- Toughened polycarbonate lens
- Anti-corrosion diecast aluminium housing
- Low power consumption
- Can be used on 12/24v vehicles
- With adjustable mounting bracket and 1 x M8x25 fixing bolt, nut & spring washer
- 30cm cable



LED Worklamps

LED Worklamps

12/24V 15W FLOOD LED WORKLAMP

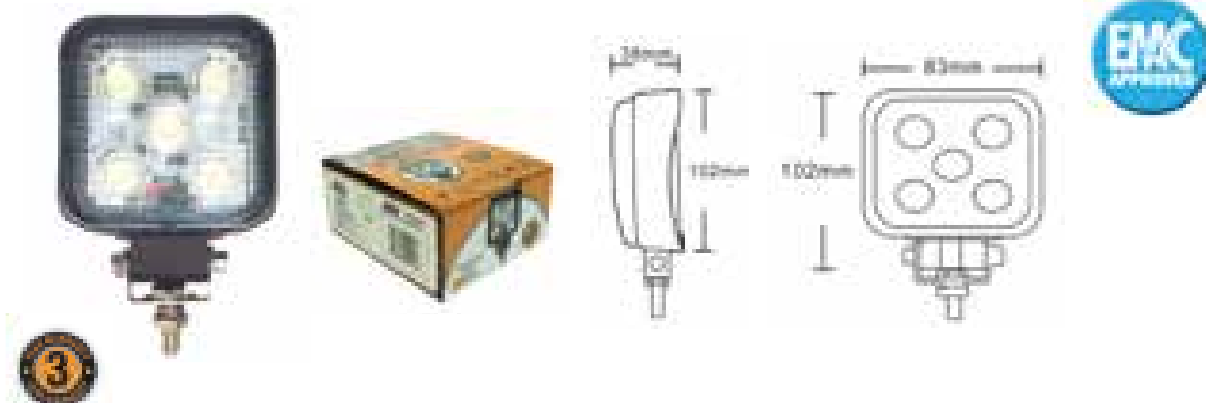

Display Pack	Voltage	Wattage	LEDs & Watts	IP Rating	Lumens	Beam Pattern
MP5053	12/24V	15W	5x3W	IP67	800lm	Flood

12/24V 24W FLOOD LED WORKLAMP

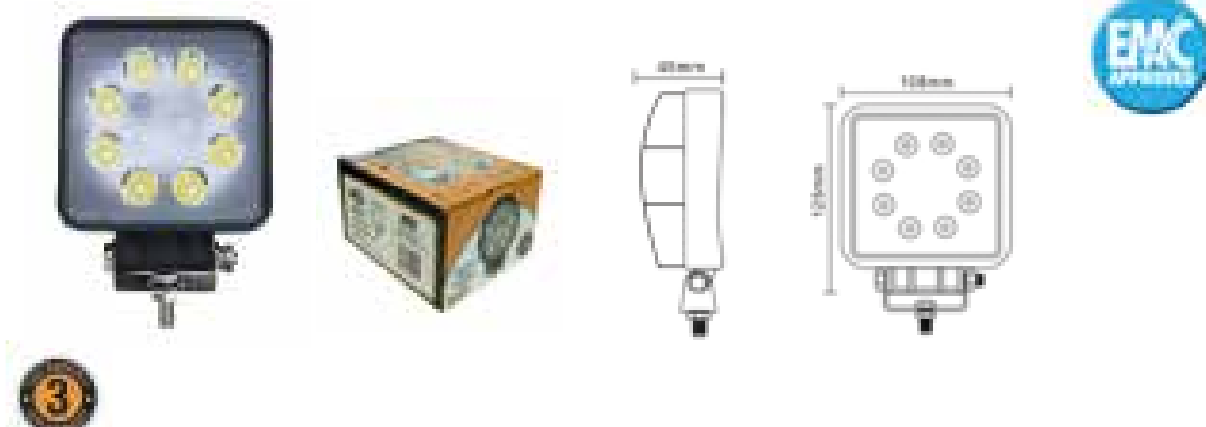

Display Pack	Voltage	Wattage	LEDs & Watts	IP Rating	Lumens	Beam Pattern
MP5055	12/24V	24W	8x3W	IP67	1250lm	Flood

12/24V 27W FLOOD LED WORKLAMP

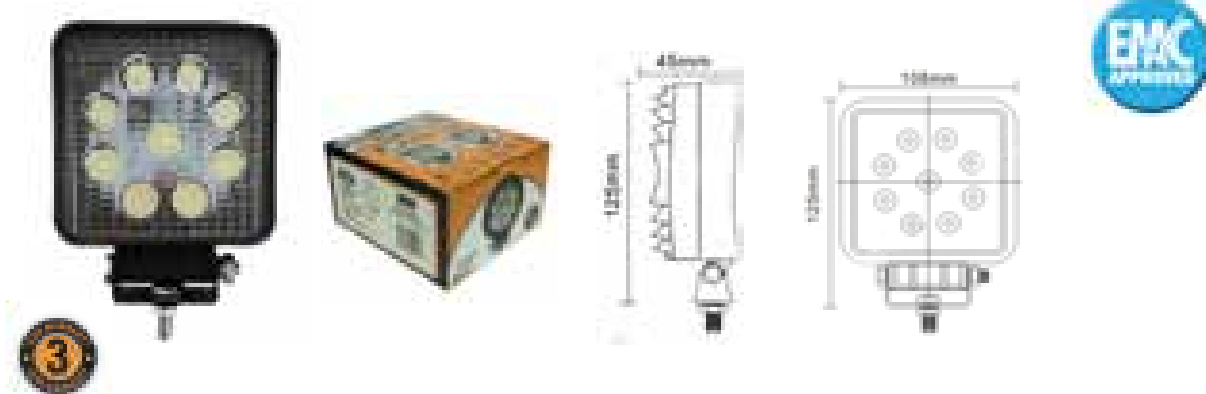

Display Pack	Voltage	Wattage	LEDs & Watts	IP Rating	Lumens	Beam Pattern
MP5057	12/24V	27W	9x3W	IP67	1400lm	Flood

LED Worklamps

12/24V 48W FLOOD LED WORKLAMP

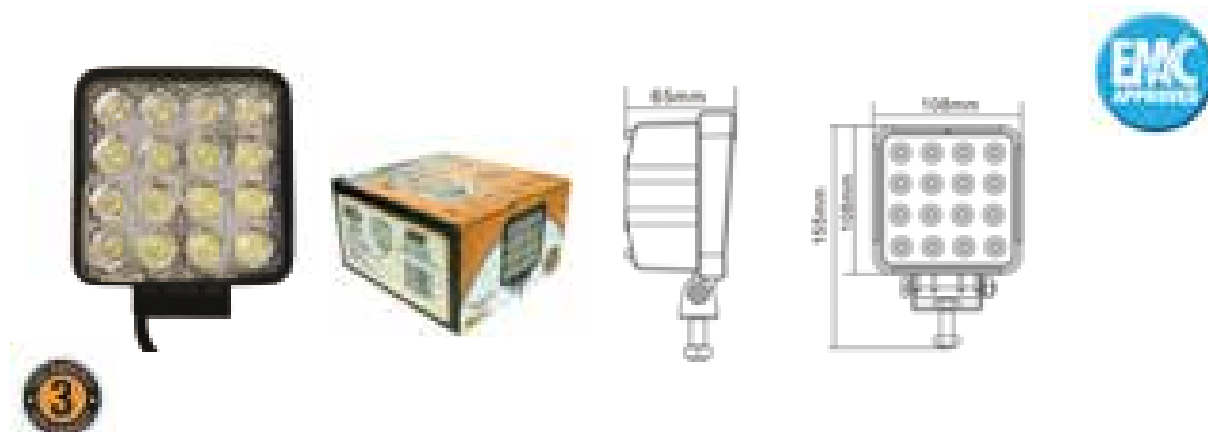

Display Pack	Voltage	Wattage	LEDs & Watts	IP Rating	Lumens	Beam Pattern
MP5058	12/24V	48W	16x3W	IP67	3800lm	Flood

12/24V 18W SPOT LED WORKLAMP

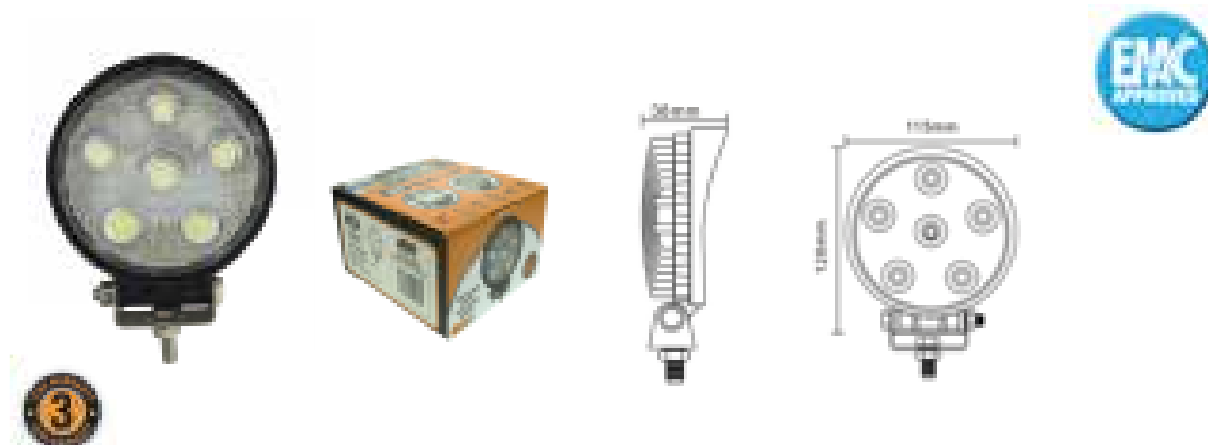

Display Pack	Voltage	Wattage	LEDs & Watts	IP Rating	Lumens	Beam Pattern
MP5064	12/24V	18W	6x3W	IP67	1000lm	Spot

12/24V 24W SPOT LED WORKLAMP



Display Pack	Voltage	Wattage	LEDs & Watts	IP Rating	Lumens	Beam Pattern
MP5066	12/24V	24W	8x3W	IP67	1250lm	Spot

LED Worklamps

12/24V 27W SPOT LED WORKLAMP



Display Pack	Voltage	Wattage	LEDs & Watts	IP Rating	Lumens	Beam Pattern
MP5068	12/24V	27W	9x3W	IP67	1400lm	Spot

12/24V 18W SLIMLINE LED WORKLAMP

- Adjustable steel mounting brackets and fixings



Display Pack	Voltage	Wattage	LEDs & Watts	IP Rating	Lumens	Beam Pattern
MP5069	12/24V	18W	6x3W	IP67	1260lm	Spot

12/24V 30W SPOT LED WORKLAMP

- Strong magnetic base
- 3m curly cord cable with cigar lighter

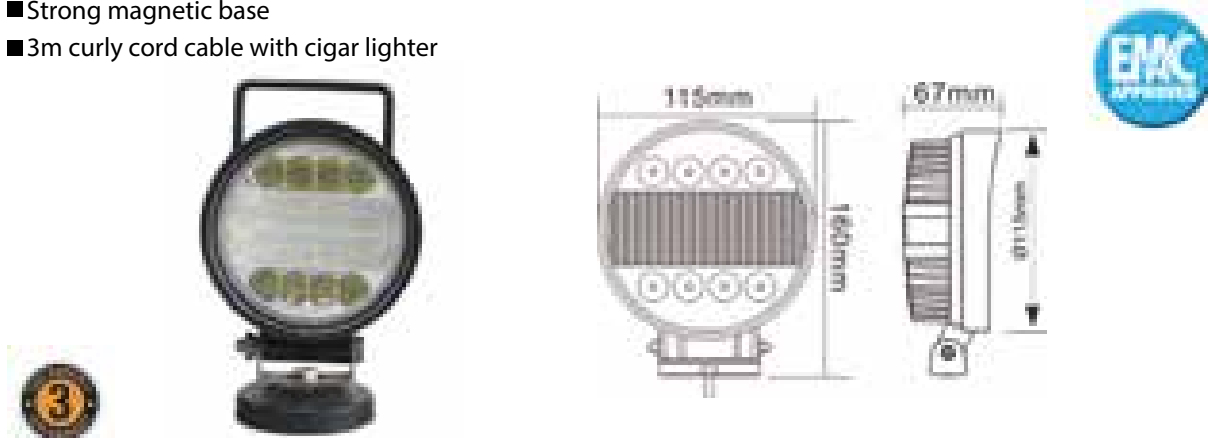

Display Pack	Voltage	Wattage	LEDs	IP Rating	Lumens	Beam Pattern
MP5075	12/24V	30W	20	IP67	2100lm	Spot/Flood Dual

Light Bars



- High intensity long life LEDs
 - Daylight colour output of 6500K
 - Waterproof and dustproof
 - Toughened polycarbonate lens
 - Anti-corrosion diecast aluminium housing
 - Low power consumption
 - Supplied with adjustable steel mounting bracket and fixings
- Note: LED light bars are work lamps and are not suitable as driving lamps*



12/24V 18W LED LIGHT BAR

- 1 x M8x25 fixing bolt, nut & spring washer

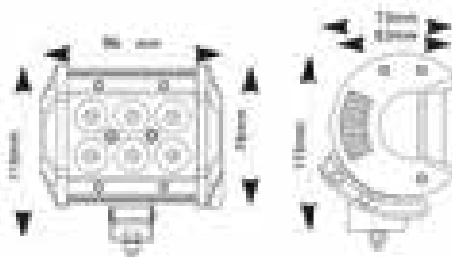

Display Pack	Voltage	Wattage	LEDs & Watts	IP Rating	Lumens	Beam Pattern
MP5070	12/24V	18W	6x3W	IP67	1260lm	Spot

LED Light Bars

12/24V 36W LED LIGHT BAR - SMALL

■ 1 x M8x25 fixing bolt, nut & spring washer

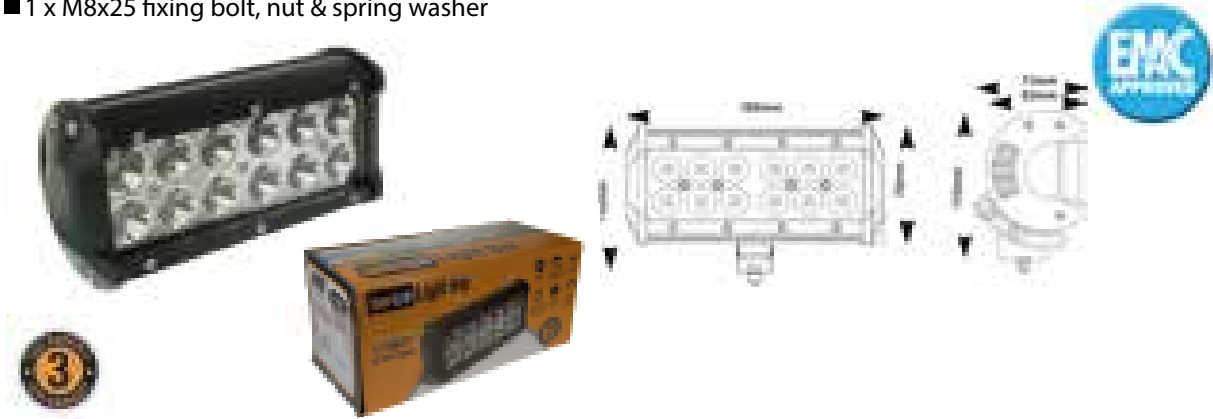

Display Pack	Voltage	Wattage	LEDs & Watts	IP Rating	Lumens	Beam Pattern
MP5071	12/24V	36W	12x3W	IP67	2520lm	Spot

12/24V 72W SPOT LED LIGHT BAR - MEDIUM

■ 2 x M8x25 fixing bolt, nut & spring washer



Display Pack	Voltage	Wattage	LEDs & Watts	IP Rating	Lumens	Beam Pattern
MP5072	12/24V	72W	24x3W	IP67	5040lm	Spot/Flood-Dual

12/24V 126W LED LIGHT BAR - LARGE

■ 3 x M8x25 fixing bolt, nut & spring washer



Display Pack	Voltage	Wattage	LEDs & Watts	IP Rating	Lumens	Beam Pattern
MP5073	12/24V	126W	42x3W	IP67	8820lm	Spot/Flood-Dual

LED Interior Lamps

LED Interior Lamps

- Exclusive to Maypole
- IP67
- Low power consumption
- 3 year warranty
- High light output
- Suitable for vans, caravans, motorhomes, van conversions, welfare units etc

LED INTERIOR LAMP WITH ON/OFF SWITCH

- Illuminated blue touch switch
- 2 colour bezels supplied; gloss white and matt silver



Bulk Pack	Voltage	LEDs	Colour Temp	Light Output	Power Consumption	Mount
MP8282B	10/30v	46	3200K Warm White	430lm	4.7W	Surface

LED INTERIOR LAMP WITH DIMMER SWITCH

- Illuminated blue touch dimmer switch
- 2 colour bezels supplied; gloss white and matt silver

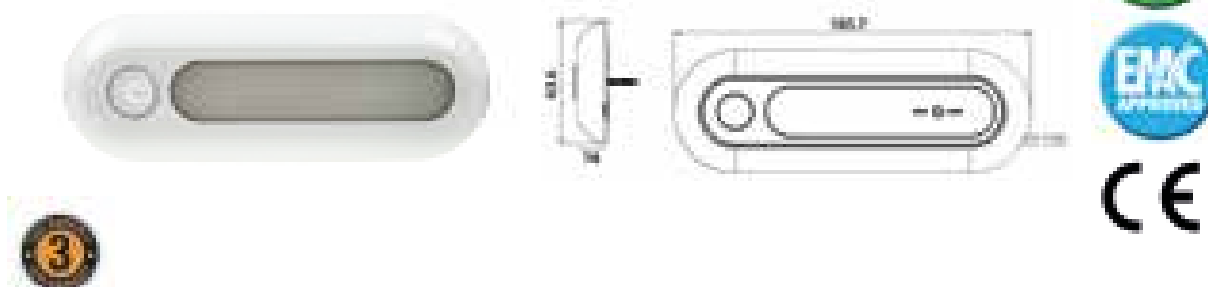

Display Pack	Bulk Pack	Voltage	LEDs	Colour Temp	Light Output	Power Consumption	Mount
MP8283	MP8283B	10/30v	46	3200K Warm White	430lm	4.7W	Surface

LED INTERIOR LAMP WITH PIR SENSOR

- PIR infrared sensor; 5m range, off after 30 seconds of no detection, 120° sensor angle
- Economical power saving option
- 2 colour bezels supplied; gloss white and matt silver



Display Pack	Bulk Pack	Voltage	LEDs	Colour Temp	Light Output	Power Consumption	Mount
MP8284	MP8284B	10/30v	46	3200K Warm White	430lm	4.7W	Surface

LED Interior Lamps

LED ROUND INTERIOR LAMP

■ 2 colour bezels supplied; gloss white and matt silver

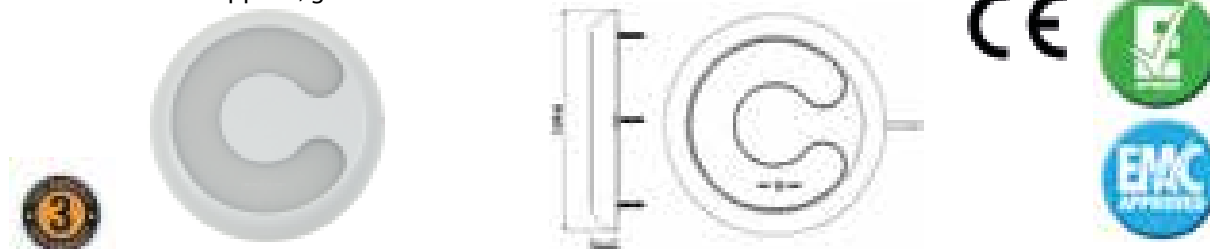

Display Pack	Bulk Pack	Voltage	LEDs	Colour Temp	Light Output	Power Consumption	Mount
-	MP8271B	10/30v	72	3200K Warm White	678lm	7.5W	Surface

LED ROUND INTERIOR LAMP WITH ON/OFF SWITCH

■ Illuminated blue touch on/off switch

■ 2 colour bezels supplied; gloss white and matt silver

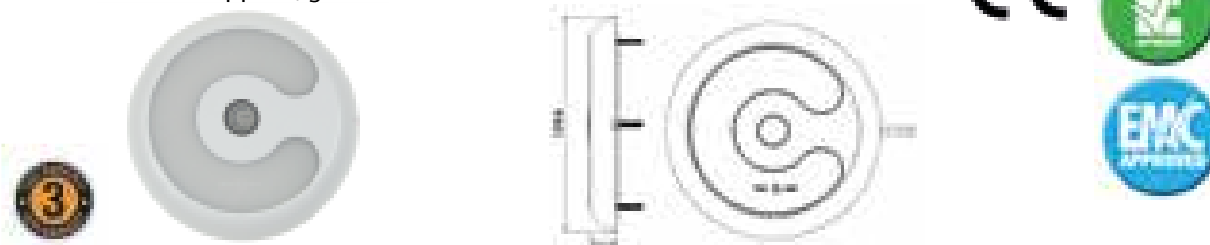

Display Pack	Bulk Pack	Voltage	LEDs	Colour Temp	Light Output	Power Consumption	Mount
-	MP8272B	10/30v	72	3200K Warm White	678lm	7.5W	Surface

LED ROUND INTERIOR LAMP WITH DIMMER SWITCH

■ Illuminated blue touch dimmer switch

■ 2 colour bezels supplied; gloss white and matt silver

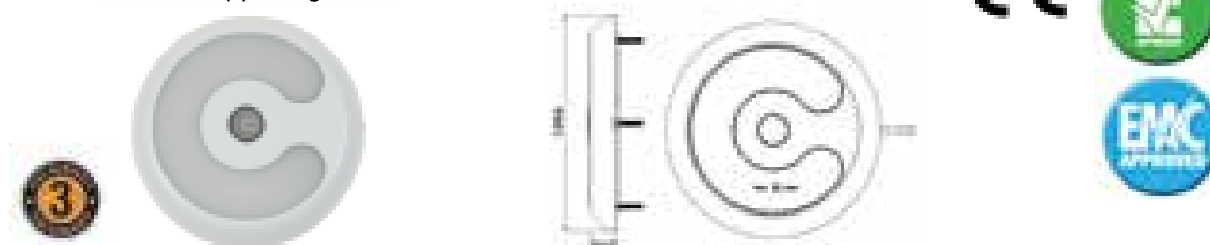

Display Pack	Bulk Pack	Voltage	LEDs	Colour Temp	Light Output	Power Consumption	Mount
MP8273	MP8273B	10/30v	72	3200K Warm White	678lm	7.5W	Surface

LED ROUND INTERIOR LAMP WITH PIR INFRARED SENSOR

■ Economical power saving option ■ Gloss white bezel only

■ PIR infrared sensor; 5m range, off after 30 seconds of no detection, 120° sensor angle

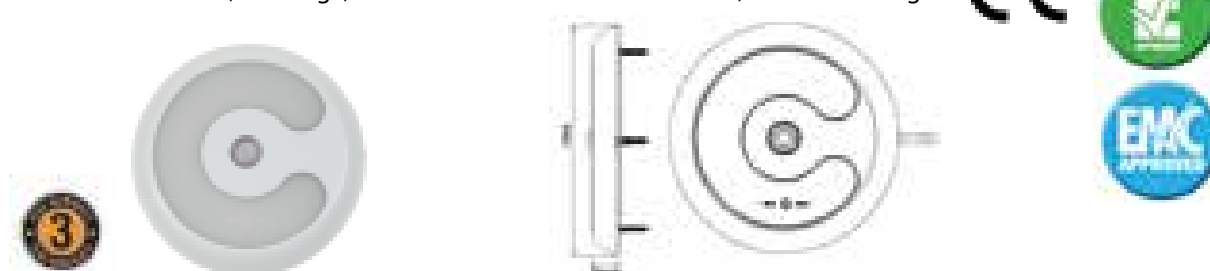

Display Pack	Bulk Pack	Voltage	LEDs	Colour Temp	Light Output	Power Consumption	Mount
-	MP8278B	10/30v	72	4000K Daylight White	678lm	7.5W	Surface

Interior & Awning Lamps

Interior and Awning Lamps

WHITE 8W INTERIOR LAMP

- 12V, 8W
- Complete with awning pole clips and 4.8m cable and battery clips
- Lightweight and compact
- Fluorescent
- 330 lumens

Length	Width	Code (Each)
355mm	55mm	MP82904



SILVER ADJUSTABLE 30 LED INTERIOR LAMP

- 12V, 30 LED
- Ideal for worktop lighting
- On/off switch
- 180° rotation to direct light
- Silver
- 288 lumens

Length	Width	Code (Each)
470mm	30mm	MP82951

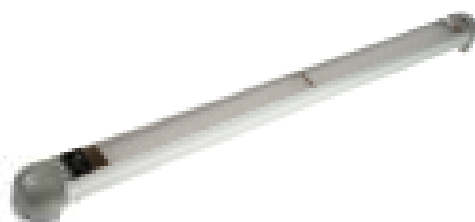

70MM LED RECESSED SPOTLIGHT

- 12/24V, 24 LED dual voltage
- Suitable for flush mounting
- Push on/off
- White or chrome casing surround included
- 108 lumens

Depth	Width	Code (Each)
30mm	80mm	MP82923



9 LED MINI READING LIGHT

- 12V, 9 LED
- On/off switch
- Silver
- Adjustable movement
- 55mm diameter
- 108 lumens

Length	Width	Code (Each)
100mm	90mm	MP82911



CEILING LAMP

- 12V
- On/off switch
- White
- Complete with 10W halogen bulb

Depth	Diameter	Code (Each)
50mm	152mm	MP82907



Interior & Awning Lamps

LED MINI SPOTLIGHT

- 12V, 9 LED
- On/off switch
- Suitable for flush or recessed mounting
- 108 lumens
- Silver casing



Depth	Width	Code (Each)
30mm	80mm	MP82921

10W AWNING/DOOR LAMP WITH HALOGEN BULB

- 12V, 10W
- Ideal for door illumination
- 140 lumens
- White
- IP66 rated
- Perfect for caravans



Length	Width	Code (Each)
250mm	90mm	MP82961

10W INTERIOR AWNING LAMP



- 12V, 10W
- On/off switch
- Britax 891
- With bulb included 1x245
- 100 lumens



Length	Width	Display	Bulk
120mm	120mm	MP35	MP35B

INTERIOR AWNING LAMP



- 12V, 20W
- On/off switch
- Britax 896
- Bulbs included
- 250 lumens



Length	Width	Code (Each)
355mm	55mm	MP877B

Index

24V Electrics 19-21

A

Adaptors 10-11
AJ.BA Connectors 60
AJ.BA Harness 57-60
Alignment Plug 13
Audible Sensor Relays 28
Automotive & Trailer Cable 4-6

B

Ball & Pin Hitches 34
Beacons 113-118
Blade Fuses 6
Beacon Brackets 118
Bulb Lamps
 Markers 81-82
 Outline Markers 82-84
 Combination 85-93
 Reverse 94
 Fog 93-94
 Numberplate 95-96
Bulb Trailer Lighting Pods 104-105
Bumper Protectors 38
Bypass Relays 29-30

C

Cable - Automotive & Trailer 4-6
Caravan Replacement Lamps 96
Charging Relays 30
Connecting Leads 7-9
Conversion Adaptors 10-11
Conversion Leads 11
Covers - Towball 39
Cycle Carrier Lighting Boards 109

D

Double-Click Connector & Cable 50

E

Extension Leads 7-8

F

Flying Socket 18

H

Harness Lamps 51-59
Heat Shrink Terminals 6
High Tensile Nuts & Bolts 36
Hitch Towing Pins 35

I

Inline Blade Fuse Holder 6
Inline Fuse Holder 6
Interior Lights 127-130

J

Junction Boxes 9

L

LED Beacons 113-118
LED Cycle Carrier Lighting Boards 109
LED Interior Lamps 127-130
LED Lamps
 Marker 61-63
 Outline Marker 63-69
 Combination 70-77
 Fog 78
 Reverse 78
 Numberplate 79
LED Trailer Lighting Boards 106-107
LED Trailer Lighting Pods 104
LED Work Lamps 121-124
Light Bars 125-126

Index

M

Mini Blade Fuse Holders	6
Mini Blade Fuse Tap	6

N

Nuts & Bolts	36
--------------	----

P

Plugs	
13 Pin	12-13
7 Pin	15-16
24V	19
Plug Cover	13
Pole Plug & Socket	32
Pre-Wired Socket Assembly	23-25

R

Radex Connectors	55
Radex Harnesses	51-55
Radex Marker Harness	52
Relays	28-31
Reflectors	110-112
Replacement Bulbs	110

S

Smart Load Devices	31
Snap Connectors	6
Sockets	
13 Pin	14-15
7 Pin	17-18
24V	19-20
Socket Mounting Plates	38
Socket Seal	27
Socket Fixings	27
Socket Cover	27
SuperSeal Connectors	47
SuperSeal Harnesses	47
Strobes	119-120

T

Towballs	33
Towball Bolts	36
Towball Covers	39
Towball Drop Plates	36
Towball Spacers	37
Towbar Testers	32
Towbar Wiring	23-25
Towbar Wiring Kits	26
Towing Jaw	34
Towsteps	37
Trailer & Automotive Cable	4-6
Trailer Lighting Boards	106-109
Trailer Lighting Pods	104-105
Trailer Retrofit Kits	50
Truck-Lite	97-101

V

Varivolt Trailer Lighting Boards	107
----------------------------------	-----

W

Washers	36
Water Dive Combination Lamps	55
Work Lamps	122-124

Wiring Codes

Wiring Codes for 12v and 24v 7 Pin and 13 Pin Connectors

12N WIRING CODE - ISO 1724

Socket viewed from the rear

Pin No.	Colour	Description
1	Yellow	Left Indicator
2	Blue	Fog Lamp
3	White	Earth Return
4	Green	Right Indicator
5	Brown	Right Position Lamps
6	Red	Brake Lamps
7	Black	Left Position Lamps

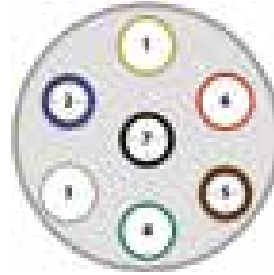

12S WIRING CODE - ISO 3732 (POST 1999)

Socket viewed from the rear

Pin No.	Colour	Description
1	Yellow	Reverse Lamps
2	Blue	Battery Charging Supply
3	White	Earth Return
4	Green	+12v Power Supply
5	Brown	Spare
6	Red	Fridge
7	Black	Earth Return

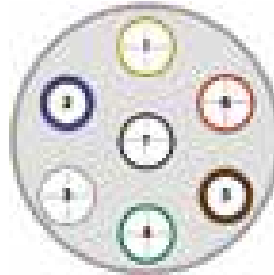

12N WIRING CODE - ISO 11446

Socket viewed from the rear

Pin No.	Colour	Description
1	Yellow	Left Indicator
2	Blue	Rear Light
3	White	Earth
4	Green	Right Indicator
5	Brown	Right Side Light
6	Red	Brake Light
7	Black	Left Side Light
8	Pink	Reverse
9	Orange	Permanent Live
10	Grey	Fridge
11	White/Black	Earth
12	White/Blue	Not Allocated
13	White/Red	Earth

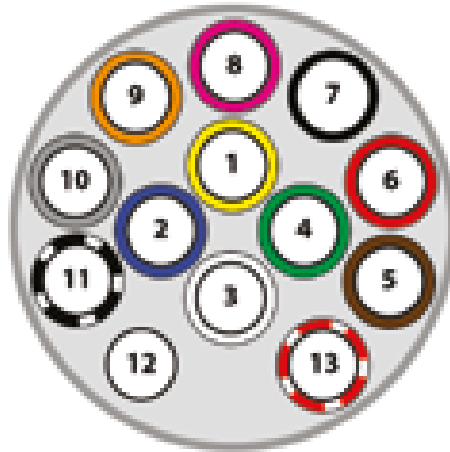

24N WIRING CODE - ISO 1185

Socket viewed from the rear

Pin No.	Colour	Description
1	White	Earth
2	Black	Left Hand Side/Tail
3	Yellow	Left Hand Indicator
4	Red	Stop
5	Green	Right Hand Indicator
6	Brown	Right Hand Side/Tail
7	Blue	Trailer Brake Control



24S WIRING CODE - ISO 3737

Socket viewed from the rear

Pin No.	Colour	Description
1	White	Earth
2	Black	ABS Fault Indication
3	Yellow	Reversing Lamps
4	Red	Permanent Live
5	Green	Control with Earth
6	Brown	Switched Live
7	Blue	Rear Fog Lamps

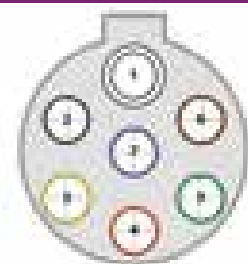

Terms and Conditions

1. INTERPRETATION

1.1 In these Conditions the following words shall have the following meanings:

"Buyer" means the purchaser of the goods;

"Conditions" means the standard terms and conditions of sale set out in this document and (unless the context otherwise requires) includes any special terms and conditions agreed in writing between the Seller and the Buyer;

"Contract" means any contract incorporating these Conditions between the Seller and the Buyer for the sale and purchase of the Goods;

"Goods" means the goods agreed in the Contract to be supplied by the Seller to the Buyer; and

"Seller" means Maypole Limited a company registered in England and Wales under number 1502304 whose registered office is at 162 Clappgate Lane, Woodgate Business Park, Birmingham B32 3DE.

1.2 In these Conditions references to any statute or statutory provision shall unless the context otherwise requires, be construed as a reference to that statute or statutory provision as from time to time amended, consolidated, modified, extended, re-enacted or replaced.

1.3 In these Conditions headings will not affect the construction or interpretation of these Conditions.

2. APPLICATION OF TERMS

2.1 Subject to any variation under condition 2.3, these Conditions comprise all the terms of the Contract between the Seller and the Buyer to the exclusion of all other terms and conditions (including any terms or conditions which the Buyer purports to apply under any purchase order, confirmation of order, specification or other document). No statement, written or oral, including statements in any price list, brochure or promotional literature of the Seller shall be incorporated into the Contract or have any legal effect.

2.2 The terms in these Conditions shall prevail over any terms put forward by the Buyer and no conduct of the Seller shall constitute acceptance of any terms put forward by the Buyer unless the Seller expressly agrees to them in writing signed by a director of the Seller.

2.3 No additions to or variations of these terms shall be binding on the Seller unless in writing signed by a director of the Seller.

2.4 No employee or agent of the Seller has any authority to make any representations on behalf of the Seller as to the effect of these terms.

2.4 Maypole do not operate a sale or return policy, all stock cleanse and returns must be authorized by a Director and a 20% re-stocking charge will be deducted

2.5 Returns will only be accepted when a Maypole return note has been completed stating reasons for the return

2.6 Maypole reserve the right to close the account if, the minimum annual spend of £1000 has not been achieved.

2.7 Account will be setup once initial order, for the value of £250.00 has been met.

3. PRICE

3.1 Unless expressly agreed in writing by a director of the Seller or the Seller's sales staff the price for the Goods shall be the price set out in the Seller's price list published on the date of delivery or deemed delivery.

3.2 The Seller reserves the right to vary its published price list by written notice to the Buyer.

3.3 Unless expressly stated otherwise all prices are exclusive of value added tax.

4. PAYMENT TERMS

4.1 Payment for the Goods is due no later than 30 days after the delivery date or date of deemed delivery.

4.2 Time for payment shall be of the essence.

4.3 The Buyer shall make all payments due under the Contract without any deduction whether by set-off, counter claim, discount, abatement or otherwise.

4.4 If the Buyer fails to pay the Seller any sum due pursuant to the Contract the Buyer;

4.4.1 will be liable to pay interest to the Seller on such sum from the due date for payment at the annual rate of 6% above the base lending rate from time to time of Lloyds Bank, accruing on a daily basis until payment is made. The Seller reserves the right to claim interest under the Late Payment of Commercial Debts (Interest) Act 1998; and

4.4.2 the Seller shall be entitled (without prejudice to its other claims and rights under the Contract) to suspend or cancel further deliveries or services under this Contract and any other contract between the Seller and the Buyer and treat the Contract as wholly repudiated by the Buyer and forthwith to terminate the Contract.

5. DELIVERY

5.1 The Seller shall use reasonable endeavours to meet any delivery date but any date named by the Seller for delivery is given and intended as an estimate only and is not to be the essence of the Contract. The Buyer shall nevertheless be bound to accept the Goods when delivered.

5.2 The Seller shall not be liable to the Buyer for any losses caused to the Buyer by the late delivery of the Goods.

6. FORCE MAJEURE

6.1 The Seller reserves the right to without liability defer the date of delivery or to cancel the Contract or reduce the volume of the Goods ordered by the Buyer (without liability to the Buyer) if it is prevented from or delayed in the carrying on of its business due to circumstances beyond the reasonable control of the Seller including, without limitation, acts of God, governmental actions, war or national emergency, acts of terrorism, protests, riot, civil commotion, fire, explosion, flood, epidemic, lock-outs, strikes or other labour disputes (whether or not relating to either party's workforce), or restraints or delays affecting carriers or inability or delay in obtaining supplies of adequate or suitable materials.

7. QUALITY

7.1 The Seller warrants that (subject to the other provisions of these Conditions) upon delivery the Goods will:

7.1.1 conform with any description given to the Buyer by the Seller; and

7.1.2 be of satisfactory quality within the meaning of the Sale of Goods Act 1994.

7.2 It is the Buyer's responsibility to inspect and test the Goods and each and every part thereof to see that they are in order.

7.3 If any of the Goods do not conform with any of the warranties in condition 7.1 the Seller shall at its sole option either:

7.3.1 repair or replace the defective Goods (or the defective part); or

7.3.2 allow full credit for the defective Goods provided that if the Seller so requests the Buyer shall at the Seller's expense return the Goods or the part of such Goods which is defective to the Seller.

8. LIMITATIONS ON LIABILITY

8.1 Subject to condition 7 the following provisions set out the entire financial liability of the Seller (including any liability for the acts or omissions of its employees, agents and sub-contractors) to the Buyer in respect of:

8.1.1 any breach of these Conditions; and

8.1.2 any representation, statement or tortious act or omission including negligence arising under or in connection with the Contract.

8.2 All warranties, conditions and other terms implied by statute or common law (save for the conditions implied by section 12 of the Sale of Goods Act 1979) are, to the fullest extent permitted by law, excluded from the Contract.

8.3 Nothing in these Conditions excludes or limits the liability of the Seller for death or personal injury caused by the Seller's negligence or fraudulent misrepresentation.

8.4 Subject to conditions 8.2 and 8.3:

8.4.1 the Seller's total liability in contract, tort (including negligence or breach of statutory duty), misrepresentation, restitution or otherwise arising in connection with the performance or contemplated performance of the Contract shall be limited to the price paid by the Buyer to the Seller for the Goods.

8.4.2 the Seller shall not be liable to the Buyer for any indirect or consequential loss or damage (whether for loss of profits, loss of business, depletion of goodwill or otherwise), costs, expenses or other claims or consequential compensation whatsoever (howsoever caused) which arise out of or in connection with the Contract.

9. TIME FOR NOTIFYING DELIVERY SHORTAGES

9.1 The Seller shall not be liable in any way whatsoever for short delivery unless the Buyer notifies the Seller of any shortage within 3 working days of date of delivery or deemed delivery.

10. RISK AND TITLE

10.1 The Goods are at the risk of the Buyer from the date of delivery.

10.2 Ownership of the Goods shall not pass to the Buyer until the Seller has received in full (in cash or cleared funds) all sums due to it in respect of:

10.2.1 the Goods; and

10.2.2 all other sums which are or which become due to the Seller from the Buyer on any account.

10.3 Until the ownership of the Goods has passed to the Buyer, the Buyer must:

10.3.1 hold the Goods on a fiduciary basis as the Seller's bailee;

10.3.2 store the Goods (at no cost to the Seller) separately from all other goods of the Buyer or any third party in such a way that they remain readily identifiable as the Seller's property;

10.3.3 not destroy, deface or obscure any identifying mark or packaging on or relating to the Goods;

10.3.4 maintain the Goods in satisfactory condition and keep them insured on the Seller's behalf for their full price against all risk to the reasonable satisfaction of the Seller. On request the Buyer shall produce the policy of insurance to the Seller; and

10.3.5 hold the proceeds of the insurance referred to in condition 10.3.4 on trust for the Seller and not mix them with any other money, nor pay the proceeds into an overdrawn bank account.

10.4 If the Buyer:

10.4.1 has a bankruptcy order made against him or makes an arrangement or composition with his creditors, or otherwise takes the benefit of any statutory provision for the time being in force for the relief of insolvent debtors, or (being a body corporate) convenes a meeting of creditors (whether formal or informal), or enters into liquidation (whether voluntary or compulsory) except a solvent voluntary liquidation for the purpose only of reconstruction or amalgamation, or has a receiver and/or manager, administrator or administrative receiver appointed of its undertaking or any part thereof, or a resolution is passed or a petition presented to any court for the winding up of the Buyer or for the granting of an administration order in respect of the Buyer, or any proceedings are commenced relating to the insolvency or possible insolvency of the Buyer; or

10.4.2 suffers or allows any execution, whether legal or equitable, to be levied on his/its property or obtained against him/it, or fails to observe/perform any of his/its obligations under the Contract or any other contract between the Company and the Buyer, or is unable to pay its debts within the meaning of section 123 of the Insolvency Act 1986 or the Buyer ceases to trade; or

10.4.3 the Buyer encumbers or in any way charges any of the Goods; then the Buyer's right to possession of the Goods shall terminate immediately, the Seller shall immediately be entitled to the price and the Seller shall be entitled (without prejudice to its other claims and rights under the Contract) to suspend or cancel further deliveries or services under this Contract and any other contract between the Seller and the Buyer and treat the Contract as wholly repudiated by the Buyer and forthwith to terminate the Contract.

10.5 The Seller shall be entitled to recover payment for the Goods notwithstanding that ownership of any of the Goods has not passed from the Seller.

10.6 The Buyer grants the Seller, its agents and employees an irrevocable licence at any time to enter any premises where the Goods are or may be stored in order to inspect them, or, where the Buyer's right to possession has terminated, to recover them.

11. INDEMNITY

11.1 The Buyer shall indemnify the Seller against all claims and demands whatsoever made by any person or persons against the Seller in respect of injury, loss or damage arising directly or indirectly from the delivery and use of the Goods supplied by the Seller, howsoever caused and whether or not amounting to negligence.

12. GENERAL

12.1 Each right or remedy of the Seller under the Contract is without prejudice to any other right or remedy of the Seller whether under the Contract or not.

12.2 If any provision of the Contract is found by any court, tribunal or administrative body of competent jurisdiction to be wholly or partly illegal, invalid, void, voidable, unenforceable or unreasonable it shall to the extent of such illegality, invalidity, voidness, voidability, unenforceability or unreasonableness be deemed severable and the remaining provisions of the Contract and the remainder of such provision shall continue in full force and effect.

12.3 Any concession made by the Seller or waiver by the Seller of any breach of, or any default under, any provision of the Contract by the Buyer will not be construed as a waiver of any of its rights under the Contract.

12.4 Failure or delay by the Seller in enforcing or partially enforcing any provision of the Contract will not be construed as a waiver of any of its rights under the Contract.

12.5 The Seller reserves the right to correct any clerical errors made by its employees at any time.

12.6 The parties to this Contract do not intend that any term of this Contract will be enforceable by virtue of the Contracts (Rights of Third Parties) Act 1999 by any person that is not a party to it.

12.7 The formation, construction and performance of this contract shall be governed in all respects by English Law and the parties submit to the exclusive jurisdiction of the English courts.



Maypole Ltd, 162 Clapgate Lane, Woodgate Business Park, Birmingham B32 3DE
Tel: +44 (0) 121 270 4301 Fax: +44 (0) 121 423 3020 Email: sales@maypoleltd.co.uk
Web: www.maypole.ltd.uk www.stronghold-security.com

THE UK'S LEADING TOWING AND TOURING COMPANY