

1969 50 2019



THE UK AND IRELAND'S LEADING TOWING AND TOURING COMPANY

Accessories for Cars, Caravans & Motorhomes



Welcome....

...to our comprehensive 'Automotive & Leisure' catalogue. There are over 160 pages of new products, more product information, latest product images and in-use shots.

Automotive

Our range of products has expanded as we have added complete new ranges and also additions to existing ones including: power packs, compressors and inspection lamps. We also have two new trolley chargers in our charger range suitable for workshop use.

Leisure

Our Maypole security section has had a lot of new additions such as parking posts and steering wheel locks, which we used to sell many years ago. The steering wheel locks are now back on the market due to the unfortunate increase of electronic car theft. We have recently launched a range of awnings and accessories that are ideal for use with caravans, motorhomes and camper vans.

Caravan & Motorhome Covers

Maypole are market leaders in supplying universal covers to the leisure market. As well as caravans and motorhomes, we also offer covers for camper vans and horse boxes. We also now have internal and external blinds for motorhomes and camper vans.

Stronghold

We have rebranded our range of Stronghold Security products and have included more images. There are also some new additions to this range such as the Apex wheel clamps suitable for a wide range of vehicles.

M-Way & Menabo

The range of universal and vehicle specific roof bars, cycle carriers and roof boxes from Italian manufacturer Menabo, are listed in this catalogue.

The Maypole Team

Terms & Conditions

Ordering

For all UK & Export orders contact our sales team by phone, email or fax.

Tel: +44 (0)121 270 4301

Email: sales@maypoleltd.co.uk

Fax: +44 (0)121 423 3020

UK Delivery Charges

Orders to the UK over £250 are carriage free for standard 2-3 working day delivery.

Orders under this amount will incur the following charges:

- 2-3 working days £8.95
- Next day £11.95 (*excluding Northern Ireland & The Channel Islands. Must be ordered before 2pm & 5 items or less*).
- Standard Royal Mail postage £4.00
- Roof Bar Specific Kits £5.95 next day before 2pm

For orders to the Channel Islands, the minimum order value is £500, please call for a carriage quotation.

Northern Ireland & Ireland Delivery Charges

Orders over £300 / €350 are carriage free.

Orders to Ireland under £300 / €350 will incur a carriage charge of £18.95.

Export Deliveries

All prices quoted are ex-works, quotations for delivery are available upon request.

Payment Terms

Maypole Ltd are suppliers to the trade only. Orders can only be placed with us when a trade account

has been opened, the value of the first order must be over £250.

Payments for goods is due no later than 30 days after the delivery date or date of deemed delivery. Maypole reserve the right to close the account if the minimum annual spend of £1000 P.A has not been achieved. Title of goods remains with Maypole Ltd until paid for in full.

Returns

While we constantly strive to deliver quality items, faulty goods with manufacturing defects can be returned to Maypole by contacting our returns team. Customers wishing to stock cleanse and return goods for other reasons must contact the sales team for authorisation first and then return at their own expense. A 20% handling charge will be deducted. Returns will only be accepted when a Maypole returns note has been completed stating reasons for the return.

Delivery shortages, invoice queries and damaged products MUST be reported within 3 working days of date of delivery.

Maypole reserve the right to change prices and charges without prior notice.

Full terms and conditions can be found on the inside of the back cover of this catalogue.

Full Marketing support is available for images, text and technical information. Please email marketing@maypoleltd.co.uk.

Contents

	Battery Maintenance Battery Chargers, Start Chargers, Power Packs & Booster Cables	4 - 23
	Accessory Essentials & Vehicle Breakdown Tow Poles, Parking Sensor, Tyre Air Accessories, Vehicle Horns & Ratchet Straps	25 - 45
	Compressors	32 - 38
	Inspection & Work Lamps	39 - 42
	Vehicle Care Car & Scooter Covers, Boot Liners, Seat Covers & Car Mats	46 - 55
	Workshop Essentials Welding, Safety Wear, Air Fittings & Tools	56 - 59
	Stronghold Security Hitchlocks & Wheel Clamps	 62 - 77
	Maypole Security Hitchlocks, Wheel Clamps & Parking Posts	 78 - 92
	Leisure Accessories Caravan Steps, Parking & Levelling & Grayston Spring Assisters	94 - 98
	Froli Levelling Solutions	 99 - 100
	Mirrors	101 - 103
	Caravan & Camping Electrics	104 - 110
	Leisure Covers Caravan, Motorhome, Camper Van & Horse Box Covers & Motorhome Internal & External Blinds	111 - 124
	Caravan Accessories Sun Canopy, Awnings, Awning Accessories, Storage Bags, Interior & Awning Lamps, Cleaning & Toilet Fluid & Power Inverters	125 - 140
	Maypole Cycle Carriers Rear Mounted Cycle Carriers	141 - 144
	M-Way & Menabo Roof Bars, Cycle Carriers & Roof Boxes	 145 - 157

Product descriptions, images and text may change without prior notice.



Battery Maintenance

The increasing demand on car batteries from advanced vehicle electrics means that regular maintenance is required to prevent a flat battery. Maypole offers a comprehensive range of battery chargers to suit a wide range of vehicles that tests, reconditions and charges a battery.

Traditional lead acid batteries are no longer the only battery type available. For vehicles with STOP/START technology, batteries need to deliver a high power performance. With this in mind, some of our battery chargers are also suitable for AGM and GEL batteries. All of our chargers are independently inspected for electrical safety.

Why buy an Electronic Smart Charger?

Traditional battery chargers, during charging the voltage increases and the current decreases progressively, without any control from the charger. Electronic battery chargers regulate both current and voltage throughout the charge cycle.

Traditional

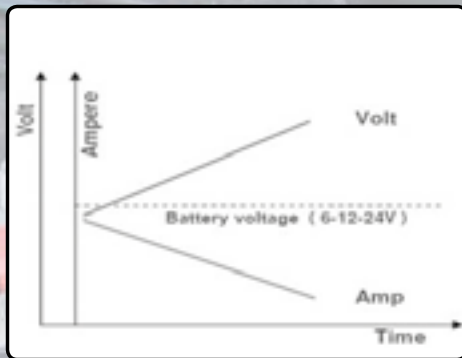

Electronic

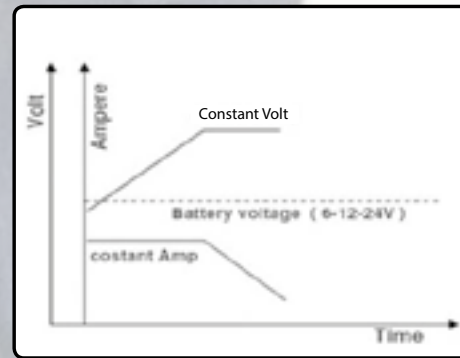

The Range

Maypole have a range of chargers to suit all requirements and budget;

- Compact** Entry level basic charger. Available in 4A and 6A.
- LED Automatic** Available from 4A to 12A in 6/24V.
- Electronic Smart Chargers** Fully automatic smart chargers suitable for a range of vehicles, including vehicles with STOP/START. Available from 0.5A to 8A.
- Electronic Smart Bench Chargers** Heavy duty automatic smart chargers suitable for a wide range of vehicles. Ideal for workshops, DIY mechanics and marine applications. Available from 12A to 25A in 12V with Start Assist functionality.
- Metal Cased Battery Chargers** Available from 8A to 30A and suitable for a wide range vehicles.
- Maypole Start Chargers** From 30A to 75A to aid starting and rapid charge on a wide range of 12/24V vehicle.
- Power Packs** Can be used to jump start vehicles up to 6L.

Catalogue Features

We have included relevant information to each range of battery chargers and highlighted key product features. To help make product selection easier we have also included easy to follow icons that are also present on the packaging.



Automatic multi stage charging



Compact design



Display showing charging information



Easy & safe to use

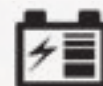

Fast charge



Suitable for stop/start vehicles



Seasonal battery maintenance



Maintenance charging



Increase performance & battery life



Float mode automatic charging maintenance



Compact & robust case



Robust metal case

Compact Battery Chargers

4A & 6A (12V) COMPACT BATTERY CHARGERS

Compact battery chargers suitable for a wide range of vehicles.

- Built in safety features - overload, reverse polarity & short circuit protection.
- 1.4m leads with insulated crocodile clips.
- Easy to read LED charge indicators.
- MP7404 suitable for vehicles up to 1.2L (1200cc).
- MP7406 suitable for vehicles up to 1.8L (1800cc).



MP7404

Compact & Robust Case

With integral handle

Handy Cable Tidy

For compact storage



LED Indicators

- Logical indication of charging status
- Red - Power
 - Green - Progressively brighter as battery becomes charged

Insulated Crocodile Clips

Technical Specification

Code	Voltage	Output (Amps)	Battery Capacity	Battery Types	Dimensions HxWxL (cm)	Weight	Box Qty
MP7404	12V	4A	10Ah - 60Ah	Lead Acid & AGM	19x16x9.5	1.2Kg	10
MP7406	12V	6A	12Ah - 80Ah	Lead Acid & AGM	19x16x9.5	1.4Kg	10

Automatic Battery Chargers

4A & 6A (12V) AUTOMATIC BATTERY CHARGERS

Fully automatic and suitable for a wide range of vehicles.

- **Float charging** - ensures batteries are maintained with no risk of overcharging.
- **Built in safety features** - overload, reverse polarity & short circuit protection.
- **1.7m leads with inline fuse protection and insulated crocodile clips.**
- **MP7104 suitable for vehicles up to 1.2L (1200cc).**
- **MP7106 suitable for vehicles over 1.2L (1200cc) and up to 1.8L (1800cc).**



MP7104

LED Indicators

Logical indication of charging status

- Red - 25 -50% charged
- Amber - 75% charged
- Green - Fully charged

Inline Output Fuse & Cover

For enhanced safety & easy replacement



Robust ABS Case
With integral handle

Insulated Crocodile Clips

Technical Specification

Code	Voltage	Output (Amps)	Battery Capacity	Battery Types	Dimensions HxWxL (cm)	Weight	Box Qty
MP7104	12V	4A	12Ah - 48Ah	Lead Acid & AGM	18.5x18x11	1.8Kg	10
MP7106	12V	6A	20Ah - 80Ah	Lead Acid & AGM	18.5x18x11	2.2Kg	10

Automatic Battery Chargers

8A & 12A (DUAL VOLTAGE) AUTOMATIC BATTERY CHARGERS

Fully automatic and suitable for a wide range of vehicles.

- **Float charging** - ensures batteries are maintained with no risk of overcharging.
- **Built in safety features** - overload, reverse polarity & short circuit detection.
- **1.7m leads with inline fuse protection and insulated crocodile clips.**
- **MP7108 is suitable for vehicles up to 1.8L (1800cc).**
- **MP7112 is suitable for vehicles exceeding 2L (2000cc).**



MP7108

LED Indicators

Logical indication of charging status

- Red - 25 -50% charged
- Amber - 75% charged
- Green - Fully charged

Dual Voltage

MP7108 - 6/12V
MP7112 - 12/24V

Inline Output Fuse & Cover

For enhanced safety & easy replacement



Compact Robust ABS Case
With integral handle

Insulated Crocodile Clips



Code	Voltage	Output (Amps)	Battery Capacity	Battery Types	Dimensions HxWxL (cm)	Weight	Box Qty
MP7108	6/12V	8A	20Ah - 100Ah	Lead Acid & AGM	26.5x19.8x12.3	2.9Kg	5
MP7112	12/24V	12A	20Ah - 160Ah	Lead Acid & AGM	25.4x22.8x10.2	3.9Kg	5

Electronic Smart Chargers

0.5A (12V) AUTOMATIC TRICKLE CHARGER

Fully automatic compact plug in trickle charger. Ideally suited to long term battery maintenance, for example when a vehicle isn't in frequent use.

- **9 stage charging cycle** - automatically assesses the battery voltage & condition before diagnosing, charging & maintaining the battery.
- **Built in safety features** - overload, reverse polarity & short circuit protection.
- **1.5m leads with insulated crocodile clips.**



Compact Design

With insulated crocodile clips

Multi-Function LED Indicator

- Flashing red - battery, connection & fault diagnosis
- Solid red - bulk charging
- Flashing green - >80% charged, absorption charging
- Solid green - charged, maintenance mode



Technical Specification



MP7402 9 Step Charging Cycle

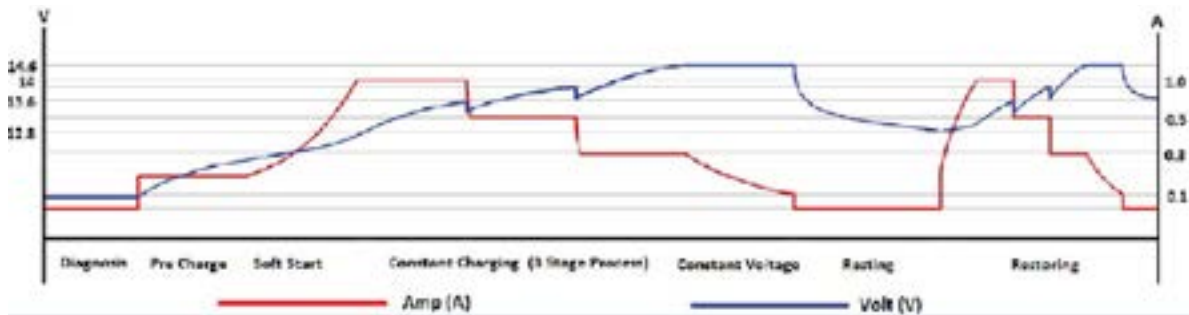

Code	Voltage	Output (Amps)	Battery Capacity	Battery Types	Dimensions HxWxL (cm)	Weight	Box Qty
MP7402	12V	0.5A	1.2Ah - 100Ah	Lead Acid, AGM & GEL	10x7.6x16	0.3Kg	24

Electronic Smart Chargers

1.5A (6/12V) ELECTRONIC MAINTENANCE SMART CHARGER

Fully automatic dual volt charger perfect for long term maintenance charging and battery charging.

- **9 stage charging cycle** - automatically assesses the battery voltage & condition before re-conditioning, charging & maintaining the battery where required.
- **Built in safety features** - reverse polarity, short circuit & open circuit detection.
- **1.5m leads with interchangeable insulated crocodile clips or ring terminals.**
- **Suitable for maintenance charging & battery charging up to 1.2L (1200cc).**
- **High frequency charger** - does not have a transformer.



LED Indicators

Logical indication of charging status

1. Green - Power
2. Amber - Charging
3. Green - Charged
4. Red - Error

Interchangeable Leads

Insulated crocodile clips & ring terminals



Voltage Indicators & Selector
For dual voltage charging (6V/12V)

Permanent Quick Connect
Ideals for motorcycles, scooters & caravans

Technical Specification

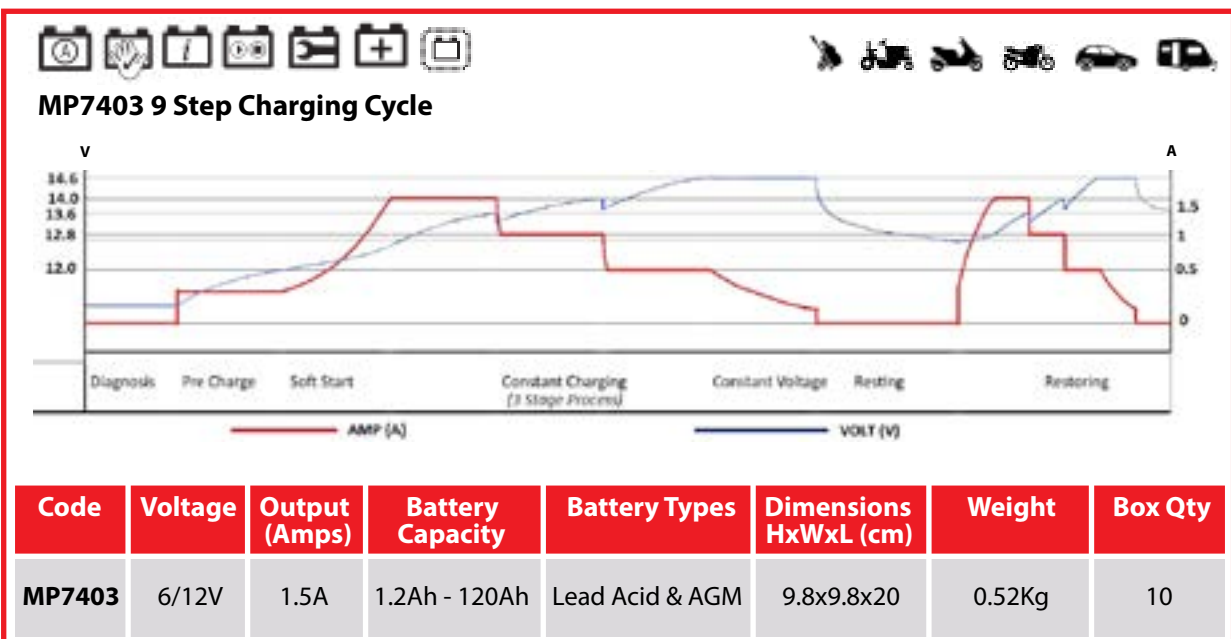

4A (6/12V) ELECTRONIC SMART CHARGER

Fully automatic dual voltage smart charger recommended for a wide range of vehicles.

- **5 stage charging cycle** - automatically detects the battery voltage & condition before re-conditioning, charging & maintaining the battery.
- **Built in safety features** - overload, reverse polarity & short circuit detection.
- **1.5m leads with interchangeable insulated crocodile clips & ring terminals.**
- **Suitable for a wide range of vehicles up to 2.5L (2500cc).**
- **High frequency charger** - does not have a transformer.



LCD Display

Indicators showing: reverse polarity, faulty connection, faulty battery, battery level, 12V winter charge & 6/12V slow & fast charge

Permanent Quick Connect

Ideals for motorcycles, scooters & caravans



Interchangeable Leads

Insulated crocodile clips & ring terminals

Technical Specification



MP7423 5 Step Charging Curve

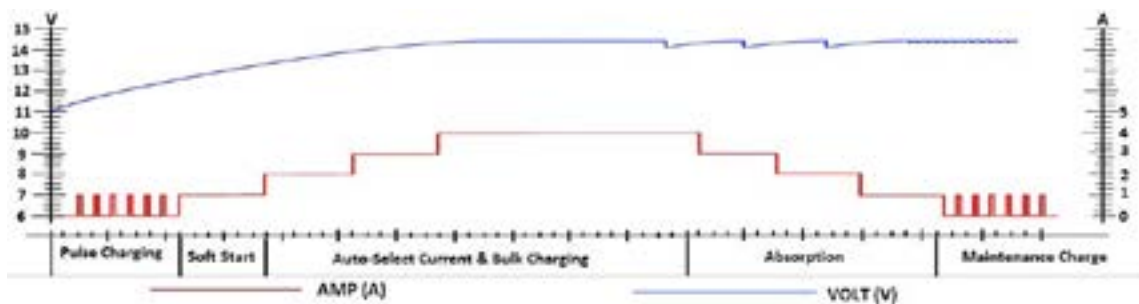

Code	Voltage	Output (Amps)	Battery Capacity	Battery Types	Dimensions HxWxL (cm)	Weight	Box Qty
MP7423	6/12V	4A	1.2Ah - 120Ah	Lead Acid & AGM	26x15x6	0.69Kg	12

Electronic Smart Chargers

8A (12V) ELECTRONIC SMART CHARGER

Fully automatic powerful smart charger recommended for a wide range of vehicles.

- **9 stage charging cycle** - automatically detects the battery voltage & condition before diagnosing, charging & reconditioning the battery.
- **Built in safety features** - reverse polarity, short circuit & open circuit detection.
- **1.5m leads with insulated crocodile clips.**
- **Suitable for vehicles up to 5L (5000cc).**
- **High frequency charger** - does not have a transformer.



LCD Display

Showing key charging information:

- Battery voltage
- Charging current
- % of full battery capacity

LED Indicators

Logical indication of charging status

- Green - Power
- Amber - Charging
- Green - Charged
- Red - Error

Selectable Display Options

Battery voltage, charging current, % of full battery capacity

Robust Case

Wall mountable



Technical Specification



MP7428 9 Step Charging Cycle

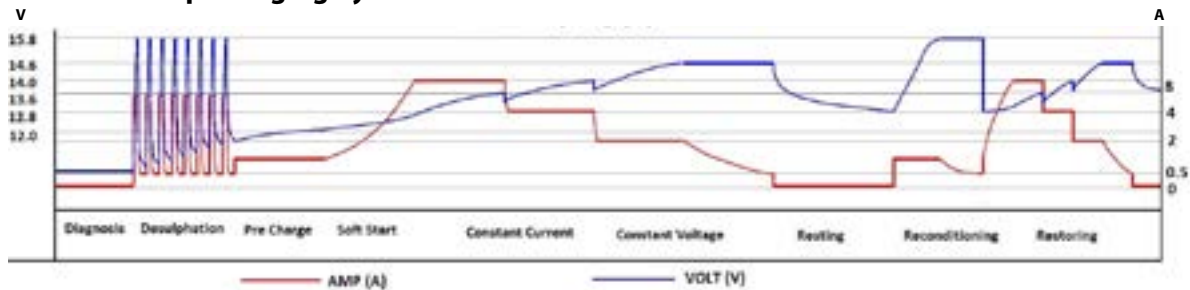

Code	Voltage	Output (Amps)	Battery Capacity	Battery Types	Dimensions HxWxL (cm)	Weight	Box Qty
MP7428	12V	8A	1.2Ah - 192Ah	Lead Acid & AGM	23x12x7	0.83Kg	8

Automatic Workshop Chargers

12/24V AUTOMATIC WORKSHOP CHARGERS

The smart charging solution for modern vehicle batteries.

- Suitable for 12V/24V lead acid/AGM & GEL batteries.
- Fully automatic charging cycles - for optimum charging/maintenance & safety.
- Digital display, showing key charging information - Volts, Amps, % of full battery capacity.
- Suitable for heavy duty batteries from 6-300Ah.



MP7212

Robust Metal Case

Charging Status Indicator

Reverse Polarity Indicator

Battery Type Options

Lead acid/ AGM & GEL batteries

1.8m Leads

with fully insulated crocodile clips

4 Charge Rate Options

12V 3A & 12A; 24V 3A & 6A

3 Display Options

Volts, Amps and % of battery capacity



Technical Specification



Code	Voltage	Amp	Battery Capacity	Engine Start Function	Charging Rate Options	Dimensions (HxWxD)	Weight	Box Qty
MP7212	12/24V	12A	6-200Ah	75A (12V only)	12V 3A & 12A; 24V 3A & 6A	13x27x19cm	6.1Kg	2
MP7220	12/24V	20A	6-300Ah	150A (12V only)	12V 3A & 20A; 24V 3A & 12A	13x27x20	8.5Kg	2

Metal Cased Battery Chargers

8A, 12A, 20A & 30A METAL CASED BATTERY CHARGERS

A comprehensive range of metal cased battery chargers for a wide range of 12/24V vehicles. Ideal for workshop use.

- Built in safety features - overload, reverse polarity & short circuit detection.
- 1.5m leads with insulated crocodile clips.
- Suitable for - lead acid & AGM batteries.
- TUV Approved.



MP716

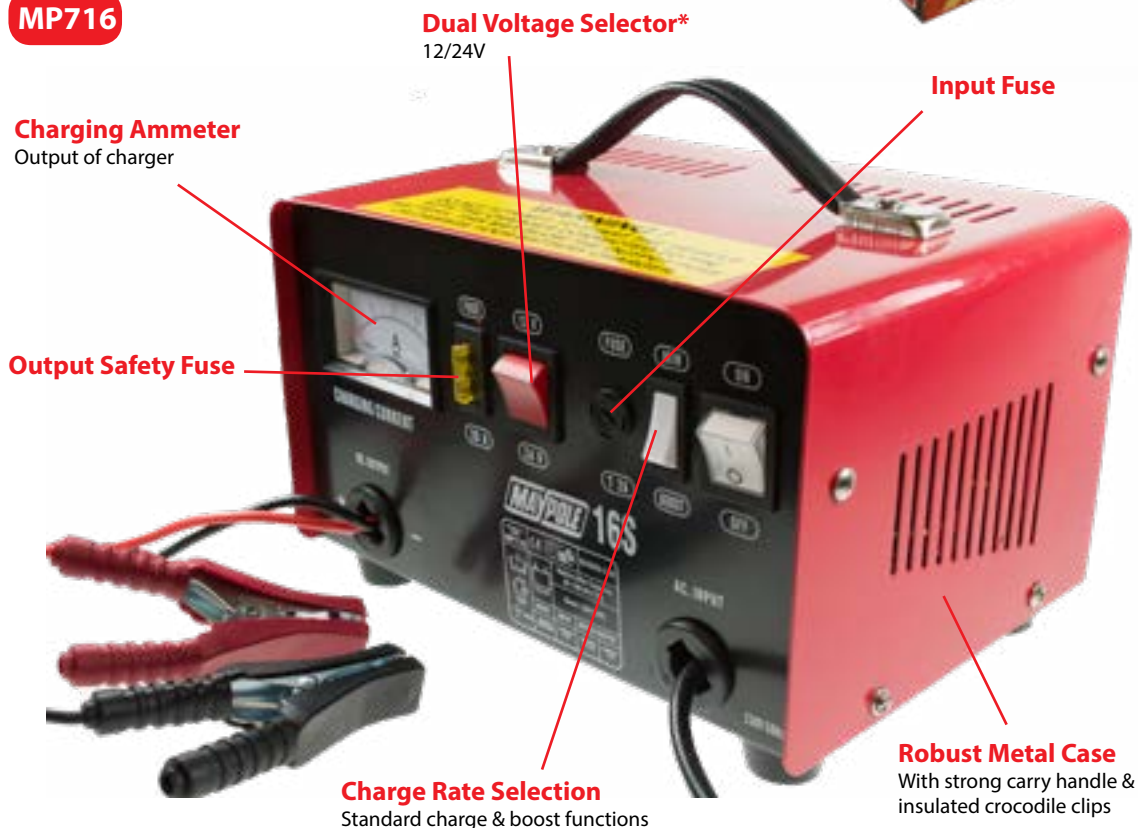

Technical Specification

Code	Voltage	Output (Amps)	Battery Capacity	Spare Output Fuse	Dimensions HxWxL (cm)	Weight	Box Qty
MP713	12V	8A	20Ah - 90Ah	MP3015 (15A)	175x280x205	4.2Kg	4
MP716	12/24V	12A	30Ah - 180Ah	MP3020 (20A)	175x210x210	6.04Kg	2
MP730	12/24V	20A	100Ah - 250Ah	MP3030 (30A)	260x390x230	11.71Kg	2
MP750	12/24V	30A	120Ah - 320Ah	MP75040 (40A)	285x430x285	13.5Kg	1

*MP730 & MP750 have terminals to select the output voltage

Trolley/Start Chargers

75A (12/24V) MAYPOLE START CHARGER

Maypole 75A start charger suitable for large capacity batteries of 12/24V vehicles. Ideal for workshop use.

- Built in safety features - overload & reverse polarity protection.
- Suitable for - lead acid & AGM batteries.
- 2m leads with insulated crocodile clips.
- TUV Approved.
- 16A supply is required.



Technical Specification

Code	Voltage	Max Power Input (Kw)	EN Rated Charging Current (A)	Max Charging Current Peak (A)	EN Rated Starting Current (A)	Max Starting Current Peak (A)	Boosting Current 0 Volt (A)	Battery Capacity (Ah)	Cable Length (mm)	Dims (mm)	Weight (Kg)
MP725	12/24V	6.5	25/30	75	300	450	50	120-750	2000	H 670 D 285 L 300	28

Trolley/Start Chargers

12/24V AUTOMATIC WORKSHOP TROLLEY/START CHARGERS

Fully automatic workshop trolley/start chargers with a built in intelligent micro processor and engine start function.

- **Built in safety features** - spark proof, reverse polarity, short circuit, overload and over current protection.
- **Fully automatic** - 10 stage charging process.
- **Repair function for old or sulphated batteries.**
- **Easy to manoeuvre with retractable handle and heavy duty wheels.**
- **Detailed messages on rolling screen.**
- **Alternator check function.**
- **Independent battery type selection** - STD/AGM/GEL.
- **Ideal for the workshop environment.**



Technical Specification



10 Step Charging Cycle

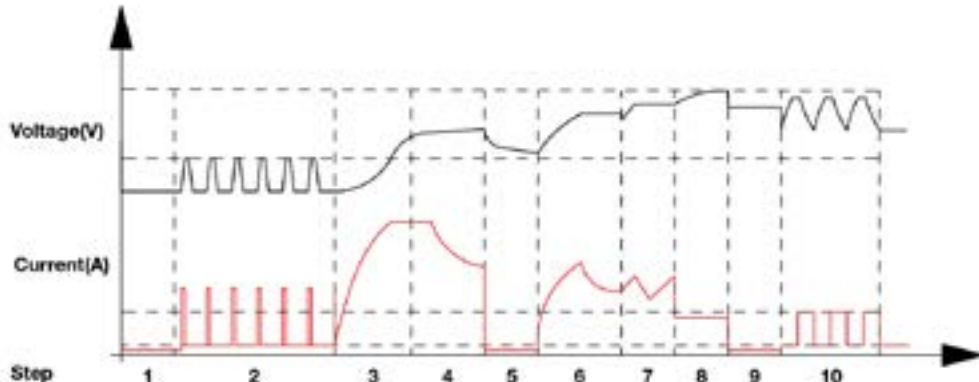

Code	Voltage	Charge Current	Engine Start Current	Dimensions (mm)	Weight (Kg)	Qty
MP726	12/24V	5A/15A/30A/40A	250A (Max) 200A (EN Rated)	66x36x33	20.5Kg	1
MP727	12/24V	20A/30A/40A/60A	350A (Max) 300A (EN Rated)	66x36x33	21Kg	1

Power Packs

300A LITHIUM ION POWER PACK

Safely jump start flat batteries of petrol engines up to 3L.

- **Suitable for** - all 12v lead acid batteries, including deep cycle, AGM and Gel
- **Smart cable technology** - reverse polarity, reverse charge, short circuit, over load, over discharge and over temperature protection
- **Complete with accessories** - 12v cigar lighter charger, smart cable jump lead, USB multi output cable for smart phones and handy carry bag
- **Can also be used as a power bank**
- **SGS safety tested**



Technical Specification

Code	Battery Capacity	Starting Current	Peak Current	Charging Time	Life Cycle	Size	Weight
MP7429	6,000mAh	150A	300A	2 hours	1000 charges	L13 x W7 x H1cm	212g

Power Packs

400A LITHIUM ION POWER PACK

Safely jump start flat batteries of petrol engines up to 6L and diesel engines up to 3L.

- **Suitable for** - all 12v lead acid batteries, including deep cycle, AGM and Gel
- **Smart cable technology** - reverse polarity, reverse charge, short circuit, over load, over discharge and over temperature protection
- **Complete with accessories** - 12v cigar lighter charger, mains charger, smart cable jump lead, USB multi output cable for smart phones, laptop connectors (x8) with switch cable and handy carry bag
- **Can also be used as a power bank**
- **SGS tested**



Technical Specification

Code	Battery Capacity	Starting Current	Peak Current	Charging Time	Life Cycle	Size	Weight
MP7430	12,000mAh	200A	400A	3-4 hours	1000 charges	L17 x W8 x H3cm	446g

Booster Cables & Jump Leads

EMERGENCY BOOSTER CABLES / JUMP LEADS

Copper coated aluminium booster cables 170A to 350A, suited to occasional use for emergency applications.

- Greater cross sectional area (CSA) to increase cable flexibility.
- Colour coded cable made from heat, oil & acid resistant PVC.
- Insulated metal clips.
- Supplied with reusable storage bag.



MP3505



MP3506



MP3507



MP3515



Technical Specification

Code	Engine	Length Size	Cable CSA	Peak Output	Recommended For	Retail Display Box Qty	Box Qty
MP3505	Up to 1.6L	2m	7.5mm ²	170A	Motorcycles, small cars & large cars	8	16
MP3506	Up to 2L	2.5m	8.5mm ²	200A	Small cars, large cars, & vans	5	10
MP3507	Up to 2.5L	3m	11mm ²	270A	Large cars, vans, 4x4's & motorhomes	5	10
MP3515	Up to 3L	3m	15mm ²	350A	Large cars, vans, 4x4's & motorhomes	5	10

Booster Cables & Jump Leads

HEAVY DUTY BOOSTER CABLES / JUMP LEADS

Copper coated aluminium booster cables 450A to 900A, suitable for larger cars, vans, 4x4's & agricultural vehicles. Designed for more regular heavy duty use.

- Greater cross sectional area (CSA) to increase cable flexibility.
- Colour coded cable made from heat, oil & acid resistant PVC.
- Insulated heavy duty metal clips.
- Supplied with reusable storage bag.



MP3525 & MP3526



MP3527



Technical Specification

Code	Engine	Length Size	Cable CSA	Peak Output	Recommended For	Box Qty
MP3525	Up to 4L	3m	25mm ²	450A	Large cars, vans, 4x4's & motorhomes	5
MP3526	Up to 6L	3.5m	30mm ²	600A	Vans, 4x4's, motorhomes, tractors & trucks	5
MP3527	Up to 8L	4m	45mm ²	900A	Vans, 4x4's, motorhomes, tractors & trucks	5

MOTORIST BOOSTER CABLES / JUMP LEADS

Available in the popular sizes of 170A, 350A & 400A peak values; suitable for motorcycles to large cars & vans. A hybrid mix for increased flexibility & performance.

- Maximised cross sectional area (CSA) to increase cable flexibility & maximise power transfer.
- Colour coded cable leads made from heat, oil & acid resistant PVC.
- Insulated metal clips.
- Supplied with reusable storage bag.



MP350



MP351 & MP352



Technical Specification

Code	Engine Size	Length	Cable CSA	Peak Output	Recommended For	Box Qty
MP350	Up to 1.6L	2m	5mm ²	170A	Motorcycles, small cars & large cars	16
MP351	Up to 3L	3m	10mm ²	350A	Large cars, vans, 4x4's & motorhomes	10
MP352	Up to 4L	3m	16mm ²	400A	Large cars, vans, 4x4's & motorhomes	5

Booster Cables & Jump Leads

PROFESSIONAL BOOSTER CABLES / JUMP LEADS

500A to 1200A 100% copper booster cables, ideal for commercial applications including workshop & vehicle recovery through to heavy duty agricultural & plant equipment. Fitted with tough heavy duty clamps for increased safety & reliability under regular use or extreme conditions.

- Maximised cross sectional area (CSA) to increase cable flexibility & maximise power transfer.
- Colour coded cable made from heat, oil & acid resistant PVC.
- Insulated heavy duty metal clips.
- Supplied with reusable storage bag.



MP353, MP354 & MP355

MP356



Technical Specification

Code	Engine Size	Length	Cable CSA	Peak Output	Recommended For	Box Qty
MP353	Up to 6L	4m	20mm ²	500A	Cars, vans & trucks	5
MP354	Up to 7L	4m	30mm ²	700A	Tractors, vans, recovery vehicles & lorries	5
MP355	Up to 8L	4m	35mm ²	900A	Tractors, vans, recovery vehicles & lorries	5
MP356	Up to 9.5L	4.5m	50mm ²	1200A	Recovery vehicles, plant equipment, HGVs & agricultural	4

Maypole offer one of the most comprehensive ranges on the market today!



BOOSTER CABLE CLIPS

- Insulated clips
- 500 amp constant and 900 amp peak
- Display pack of one set (red/black)



	Display Pack	Bulk Pack
Pair	MP340	-
Red clip	-	MP340BR
Black clip	-	MP340BB

HEAVY DUTY BOOSTER CABLE CLIPS

- Heavy duty, insulated clips
- 700 amp constant and 1200 amp peak
- Display pack of one set (red/black)



	Display Pack	Bulk Pack
Pair	MP344	-
Red clip	-	MP344BR
Black clip	-	MP344BB

QUICK RELEASE BATTERY CLAMPS

- Insulated
- Quick release mechanism
- Ideal for leisure and marine applications



	Display Pack	Bulk Pack
Pair	MP333	-
Red clip	-	MP333BR
Black clip	-	MP333BB

Maypole Towing Stand

- All your top 40 towing essentials in one place.
- Modern and eye catching packaging design across our wide product range.

Available upon request we can provide recommended ranges and planograms to suit your store. Also suitable for LED lighting display.

- *Maximum 2 stands per customer*
- *Limited Availability*

Towing Stand - YTOWINGSTAND

Minimum spend of £599 or buy for £155
Silver/blue design with base bin
Storage bin is ideal for towing electrics, jockey wheels, trailer spares and security products

Dimensions: 82.5cm W x 1.8m H x 45cm D



Contact our sales team now for pricing and availability.

Accessory Essentials

A wide range of essential accessories for your travels. Including: emergency breakdown equipment, tyre accessories, reversing digital cameras, compressors, inspection lamps and covers.



Breakdown Essentials

WARNING TRIANGLE

- Fully E Approved
- Supplied in a plastic storage case
- Legal requirement when driving abroad
- Plastic inset

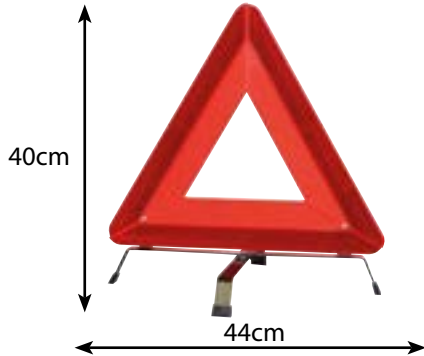

Code (Each)	Box Qty
MP120	20

HIGH VISIBILITY SAFETY VEST XL

- Class 2
- Legal requirement when driving abroad
- Ideal for site and work place safety



Code (Each)	Box Qty
MP119	10

EXTENDABLE WHEEL WRENCH 17/19MM

- Extends from 355mm to 530mm for extra leverage
- 1 reversible socket 17/19mm
- TUV/GS Approved



Code (Each)	Box Qty
MP7621	12

WARNING TRIANGLE (COMPACT)

- Fully E Approved
- Supplied in a plastic storage case
- Legal requirement when driving abroad
- Material inset

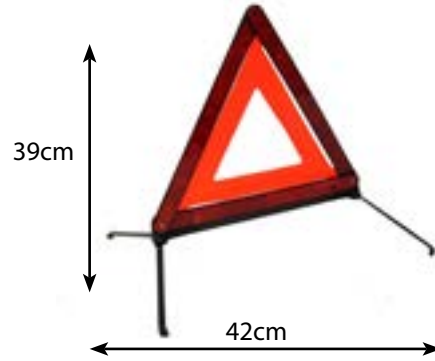

Code (Each)	Box Qty
MP1205	20

4 WAY WHEEL WRENCH

- 17mm, 19mm, 21mm and 23mm sockets
- Hanging display euro slot
- TUV/GS Approved



Code (Each)	Finish	Box Qty
MP761	Chrome	15
MP7618	Blue	15

EXTENDABLE WHEEL WRENCH 17/19/21/23MM

- Extends from 355mm to 530mm for extra leverage
- 2 reversible sockets -17mm/19mm and 21mm/23mm
- TUV/GS Approved



Code (Each)	Box Qty
MP762	12

Recovery Towing Straps & Tow Ropes

HEAVY DUTY ROADSIDE RECOVERY STRAPS

- Ideal for cars, vans, 4x4s and tractors
- 2 forged steel hooks for easy attachment
- Conforms to BS AU 187:2000
- Comes with storage bag, ON TOW sign, red safety flag and full instructions
- Made from polyester (PES)
- Bright orange for high visibility
- Alternative to tow ropes
- Supplied in zipped bags



Max Rolling Load	Length	Code (Each)	Box Qty
2500Kg	3.5m	MP6112	20
4000Kg	3.5m	MP6114	20
6500Kg	3.5m	MP6116	6

TOW ROPES

- 3.5m tow ropes
- Forged hooks
- Now with a warning flag
- 'On tow' sign and towing instructions
- Complete with storage bag
- Conforms to BSAU187



Max Rolling Load	Length	Code (Each)	Box Qty
1500Kg	3.5m	MP6091	20
2500Kg	3.5m	MP6095	20
4000Kg	3.5m	MP6097	20

2500KG ELASTICATED TOW ROPE

- 1.75m - 4m max stretched length
- Forged hooks
- Now with a warning flag
- 'On tow' sign and towing instructions
- Complete with storage bag
- Conforms to BSAU187



Max Rolling Load	Length	Code (Each)	Box Qty
2500Kg	1.75m - 4m	MP609	20

3000KG ELASTICATED TOW STRAP

- 1.75 - 4m max stretched length
- 3000Kg max rolling load
- Forged hooks and flag
- TUV/GS Approved
- Conforms to BSAU187
- 'On Tow' sign and towing instructions included



Max Rolling Load	Length	Code (Each)	Box Qty
3000Kg	1.75m - 4m	MP610	12

Tow Poles & Parking Sensor

RECOVERY TOW POLES

- 1.8m 3 section tow poles
- 1800Kg max rolling load
- TUV/GS Approved
- Storage bag included
- Red flag provided is to be fitted over the centre of the tow pole
- Two versions available. Fixed rigid and spring damper version
- A spring damper reduces compression shock loads
- Before using this product please read safety instructions fully



	Code (Each)	Box Qty
Rigid tow pole	MP489	4
Tow pole with spring damper	MP4895	4

PARKING SENSOR KIT

- This 12V DIY reverse parking aid has an LED distance display & audible warning buzzer reducing your chances of collisions when parking
- Kit includes 4 sensors, control unit and slim line dashboard display
- Working voltage: 9-16v DC
- Can be used when a towball and spare wheel is fitted
- Graduated colour coded LED digital display alerts driver to which side of the vehicle has the obstruction
- Contains 4 easy to install ultrasonic sensors capable of detecting objects up to 1.5m
- Audible warning which can be muted
- Equipped with a sensitivity control to provide optimum results based on driving environments



Code (Each)	Box Qty
MP100	20

Wireless Digital Reversing Camera System

WIRELESS DIGITAL REVERSING CAMERA SYSTEM

Ideal for caravans, motorhomes, livestock trailers, horse boxes, vans and pick-ups

- 25m range between camera and monitor - interference free wireless connection
- Large 4.3" colour LCD screen
- 105° wide viewing angle
- 6 infrared night vision LEDs
- Reversing visual guidelines
- IP65 waterproof
- Adjustable mounting bracket for use either externally or internally
- Monitor connection - 12V cigar lighter socket
- Camera resolution: 640 x 480 pixels
- LCD monitor resolution: 480 x 272 pixels
- Easy DIY installation; choose mounting bracket for camera, connect camera cable to 12V reversing light, install monitor with cable to the 12V cigar lighter
- Second camera available (MP7411) - alternate between rear and internal view on the same monitor which is perfect for horse boxes and livestock trailers



Water Resistant Durable Case

Infrared Night Vision LEDs

High Resolution Camera



- Range between camera & monitor
- Large 4.3" Colour LCD screen
- Wide viewing angle 105°
- Integrated night vision
- Interference free wireless connection
- Reversing guidelines
- Second camera available



Internal View Camera

Surface mounted adjustable bracket for internal view



Bracket Options

Flush mounted number plate bracket for rear view - no drilling required



Window Suction Clamp

Mounting bracket with quick release

Description	Code (Each)	Box Qty
Reversing Camera System	MP7410	10
Additional Camera	MP7411	20

Tyre Air Accessories

FOOT PUMPS

- Fully TUV/GS Approved compact foot pumps available in standard or heavy duty
- Single or double cylinders for faster inflation
- Complete with adaptors suitable for cars, motorcycles, bicycles, air mattresses and sports balls etc.
- 0-100 PSI pressure gauge
- Standard or heavy duty options



MP790

MP791

Indicator Guide
For correct inflation pressure



Non-Slip Footplate
With rubber feet & locking valve connector



Adaptors included

MP784



MP790



Code	Model	Piston	Hose Length	Box Qty
MP784	Standard	Double	60cm	10
MP790	Heavy Duty	Single	70cm	10
MP791	Heavy Duty	Double	70cm	10

DIGITAL TYRE PRESSURE GAUGE

- Digital LCD displays readings accurate to within 1 psi
- Operating range between 0-150 PSI / 0.15-10 bar
- Option to measure in PSI, Bar, KPA& KG/cm²
- Automatic reset and shut-off
- Battery included



Code (Each)	Box Qty
MP7925	10

12V AIR COMPRESSORS

Portable and compact 12V air compressors suitable for a wide range of vehicles and leisure products. They all plug directly into the vehicle's cigar lighter socket for an easy connection to your vehicle. The compressors are supplied with a 3 piece adaptor suitable for inflating sports balls and small inflatables.

EMERGENCY 12V AIR COMPRESSOR

- Suitable for: motorcycles, cars, cycles, air mattresses & sports balls
- 0-30 PSI



Code	PSI Range	Inflation Time (175/70 R13 Tyre 0-30 PSI)	Cable Length	Box Qty
MP7942	0-60 PSI	8 Mins	2.8m	10

Compressors

12V AIR COMPRESSOR

Maintain and monitor tyre pressures. Essential for safety and fuel efficiency.

- Portable and compact
- High speed inflation time 3.5mins (0-36PSI/175/65/R14 tyre)
- Striking retail packaging
- Handy accessories holder; inflatables adaptor, ball adaptor & tyre valve adaptor
- 12V DC power supply - plugs directly into cigar lighter socket



Fast inflation time



Compact hose and power cord storage



1. Inflatables adaptor
2. Ball adaptor
3. Tyre valve adaptor



Bright LED light



Multiple adaptors included



Large precision analogue display (PSI/BAR)



Portable & compact

Technical Specification

Suitable for:



Code	Pressure Range	Power Cable Length	Air Line Length	Air Flow Rate	Weight	Box Qty
MP7949	0-150PSI	3m	50cm	12L/Min	1Kg	8

12V AUTOMATIC DIGITAL AIR COMPRESSOR

Maintain and monitor tyre pressures. Essential for safety and fuel efficiency.

- Portable and compact
- High speed inflation time 3.5mins (0-36PSI/175/65/R14 tyre)
- Automatic pre-set shut off
- Striking retail packaging
- Handy accessories holder; inflatables adaptor, ball adaptor & tyre valve adaptor
- 12V DC power supply - plugs directly into cigar lighter socket



Fast inflation time



Compact hose and power cord storage



1. Inflatables adaptor
2. Ball adaptor
3. Tyre valve adaptor



Super bright LED night light



Multiple adaptors included



Large precision digital display



Automatic pre set shut off



Portable & compact

Technical Specification

Suitable for:



Code	Pressure Range	Power Cable Length	Air Line Length	Air Flow Rate	Weight	Box Qty
MP7950	0-160PSI	3m	50cm	12L/Min	1Kg	4

Compressors

12V HANDHELD AIR COMPRESSOR

Maintain and monitor tyre pressures. Essential for safety and fuel efficiency.

- Portable and compact
- High speed inflation time 3.5mins (0-36PSI/175/65/R14)
- Practical handheld design
- Striking retail packaging
- Handy accessories holder; inflatables adaptor, ball adaptor & tyre valve adaptor
- 12V DC power supply - plugs directly into cigar lighter socket



Large Precision
Analogue Display
(PSI/BAR)

Bright LED Light

Quick Release
Valve Connector



On/Off Trigger
Switch
Easy To Use



Fast inflation time



Compact hose and power
cord storage



1. Tyre valve adaptor
2. Ball adaptor
3. Inflatables adaptor



Technical Specification

Suitable for:



Code	Pressure Range	Power Cable Length	Air Line Length	Air Flow Rate	Weight	Box Qty
MP7951	0-150PSI	3m	50cm	12L/Min	0.8Kg	5

12V HANDHELD AIR INFLATOR

High speed inflation! Can inflate and deflate a double airbed mattress in less than 35 seconds.

- Portable and compact
- Practical handheld design
- Striking retail packaging
- Bright LED light
- 12V DC power supply - plugs directly into cigar lighter socket



High speed inflation



Inflates and deflates a double airbed in less than 35 seconds



Compact power cord storage



Rapid Inflation/
deflation speed



Bright
LED light



Portable
& compact



Practical
Handheld
design

Technical Specification

Suitable for:



Code	Max Pressure	Power Cable Length	Air Flow Rate	Weight	Box Qty
MP7954	1.5 PSI	3m	480L/Min	0.5Kg	8

Compressors

LITHIUM ION HANDHELD COMPRESSOR

Maintain and monitor tyre pressures. Essential for safety and fuel efficiency.

- Practical handheld design
- Inflation time in under 5mins (0-36PSI/175/65/R14 tyre)
- Striking retail packaging
- Handy accessories holder; inflatables adaptor and ball adaptor
- 12V cordless lithium ion - No cables or drain on car battery
- UK charging adaptor included
- Power level indicator on battery
- Also can be used as a power bank with USB power - 2,000mAh ideal for charging phones, tablets and many more devices
- Large precision digital display
- Automatic pre-set cut off



Fast inflation time



Bright LED light



2,000mAh lithium ion power bank

Technical Specification



Bright LED light



Large precision digital display



Multiple adaptors included



Practical Handheld design



Automatic pre-set shut off



Re-chargeable & cordless

Suitable for:



Code	Pressure Range	Air Line Length	Air Flow Rate	Battery Run Time	Weight	Box Qty
MP7955	0-150PSI	30cm	22L/Min	25 mins Approx	0.5Kg	6

12V RAPID AIR COMPRESSOR

Maintain and monitor tyre pressures. Essential for safety and fuel efficiency.

- Portable and compact
- Rapid inflation time 2.5mins (0-36PSI/175/65/R14 tyre)
- Bag included
- Striking retail packaging
- Handy accessories holder; inflatables adaptor, ball adaptor & tyre valve adaptor
- 12V DC power supply - plugs directly into cigar lighter socket



Large Precision
Analogue Display
(PSI/BAR)

Robust Carry
Handle



Quick Release
Connector Valve

Heavy Duty
Metal Cylinder

Anti-vibration
rubber mounted
feet



Fast inflation time



Storage bag



1 2 3

1. Tyre valve adaptor
2. Ball adaptor
3. Inflatables adaptor



Technical Specification

Suitable for:



Code	Pressure Range	Power Cable Length	Air Line Length	Air Flow Rate	Weight	Box Qty
MP7952	0-150PSI	3m	50cm	25L/Min	1.4Kg	6

Compressors

12V HEAVY DUTY AIR COMPRESSOR

Maintain and monitor tyre pressures. Essential for safety and fuel efficiency.

- Portable and compact
- High speed inflation time 1.45mins (0-36PSI/175/65/R14 tyre) - twice as fast a standard compressor
- Heavy duty twin metal cylinder
- Anti-vibration rubber mounted feet
- Bag included
- Striking retail packaging
- 12V DC power supply - Connects directly to car battery



Quick Release Connector Valve

Bright LED Light

Anti-vibration rubber mounted feet

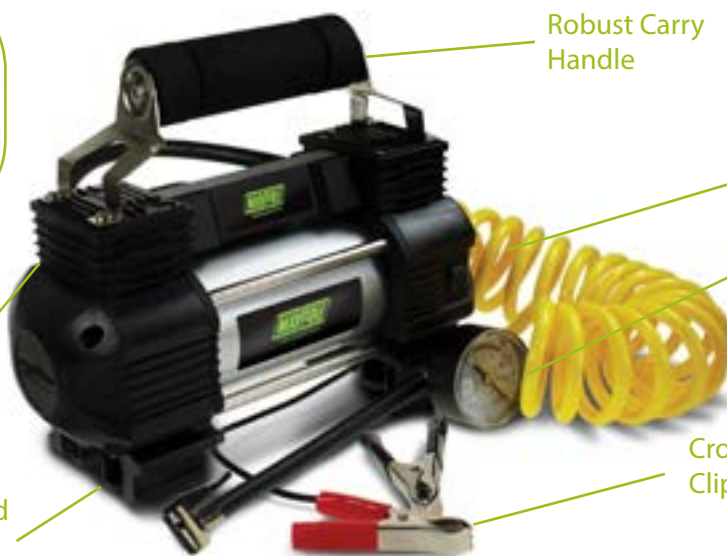

Robust Carry Handle

Extra Long Air Line Coil For Larger Vehicles

Large Precision Analogue Display (PSI/BAR)

Crocodile Battery Clips



Fast inflation time



Storage bag



Crocodile clip storage compartment



Anti-vibration rubber mounted feet



Bright LED light



Heavy duty twin metal cylinder



Large precision analogue display (PSI/BAR)



Extra long air line coil for large vehicles



Bag included

Technical Specification

Suitable for:



Code	Pressure Range	Power Cable Length	Air Line Length	Air Flow Rate	Weight
MP7953	0-150PSI	3m	6m*	35L/Min	2.3Kg

*coil fully extended

Inspection/Work Lights

PRO INSPECTION WORK LIGHTS

- Powerful and wide 5 & 10W 400 & 800 Lumen COB inspection lights
- Colour Pro CRI 95 for accurate colour rendering e.g. colour matching in paint shop repair centres
- UV-A spot light for leak detection
- IP65 dust and water protection
- Re-chargeable and cordless
- Robust aluminium case (IK08 impact resistance)
- Integral 360° metal hanging hook
- High strength magnet for storage and hands free use
- Workshop docking station for charging and storage
- Ideal for professional workshops



Technical Specification

Code	Lumens	Battery	Main Lamp Run Time	Spot Light Run Time	Charging Time	CRI Rating	Colour Temp	Box Qty
MP4051	400 lm (5w)	2x3.6V 2500mAh 9Wh	3-6hrs	10hrs	Approx. 3hrs	95	6000K Cool	10
MP4052	800 lm (10w)	3.6V 5000mAh 18Wh	3-6hrs	10hrs	Approx. 5hrs	95	6000K Cool	10

Did you know? CRI is a measure of how accurately a light source illuminates an objects true colours

Inspection/Work Lights

300 LUMEN SLIMLINE INSPECTION WORK LIGHT

- Powerful 3W COB 300lm inspection light and 20lm spot light
- Spot light for narrow spaces
- Main light has a low or high brightness setting - low setting 150lm, high setting 300lm
- Narrow design for tight/awkward spaces such as engine bays
- Re-chargeable and cordless
- 180° multi angle magnetic base for hands free use
- Ideal for home, leisure or workshop use
- IP20 rated



Technical Specification

Code	Battery	Low Setting Run Time	High Setting Run Time	Charging Time	CRI Rating	Colour Temp	Box Qty
MP4053	3.7V 1800mAh	5hrs	3hrs	3-4hrs	70	6500K Cool White	20

300 LUMEN LED EXTENDABLE WORK LIGHT

- Powerful 300 Lumen work light and 250 Lumen torch
- Re-chargeable and cordless
- Ideal for motoring, caravanning, camping or general emergency lighting
- IP20 rated

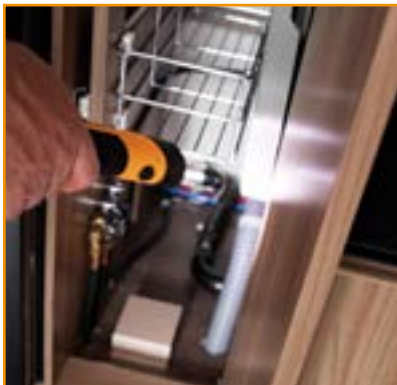

Technical Specification

Code	Battery	Main Lamp Run Time	Charging Time	CRI Rating	Colour Temp	Box Qty
MP4054	3.7V 1800mAh	2-3hrs	3-4hrs	70	6500K Cool White	20

Inspection/Work Lights

1000 LUMEN UNDER BONNET INSPECTION LIGHTS

- Powerful 5W COB 500 Lumen inspection light (two lights combined make up 1000lm)
- Options for low or high brightness setting - low setting 250lm, high setting 500lm
- 5V/2A USB output
- Robust ABS casing
- Spring loaded soft rubber bonnet grips, to prevent vehicle damage
- Detachable magnetic lights for specific area illumination
- 2600mAh power bank ideal for charging phones, tablets and many more devices
- Extra light available (MP4056) for total illumination of your working area or charging while other unit is in use
- Ideal for not only workshops but also caravanning or general household emergency lighting
- Rechargeable and cordless
- IP55 rated



Extra light (MP4056)



Magnetic base - freestanding

Folding arms for compact storage

Extendable spring loaded arms (1.2m - 1.9m)



Fully adjustable

Under bonnet padded hooks



Folds for compact storage



Under bonnet illumination



2,600mAh power bank

Technical Specification

Code	Battery	Low Lamp Run Time	High Lamp Run Time	Charging Time	CRI Rating	Colour Temp	Box Qty
MP4055	3.7V 2600mAh 9.62Wh	7hrs	4hrs	2-3hrs	70	6500K	4
MP4056	3.7V 2600mAh 9.62Wh	7hrs	4hrs	2-3hrs	70	6500K	8

Did you know? CRI is a measure of how accurately a light source illuminates an objects true colours

Vehicle Horns

VEHICLE HORNS

- High quality horns fitted to many of the world's leading vehicle manufacturers
- Disc horn tested to 500,000 cycles
- Cr3 iridescent white zinc-coating ensures high corrosion resistance
- Operating temperature -20°C - +80°C
- All horns comply with RoHS regulations
- Universal connection
- E Approved for highway use
- Mounting brackets or mounting kits included
- Twin horns gives a better dual note sound



MP892/L



MP893/L



MP895



MP896



Code	Voltage	Current	Type of Sound	dB (A)	Frequency (Hz)	Box Qty	Suitable for
MP892	12V (24V)	4A (1.5A)	High	114	430	24	
MP892L	12V (24V)	4A (1.5A)	Low	114	340	24	
MP893	12V (24V)	4A (2.5A)	High	109	500 +5%	30	
MP893L	12V (24V)	4A (2.5A)	Low	109	420 +5%	30	
MP895	12V (24V)	8A (5A)	High/Low	112	500-420 +5%	24	
MP896	12V (24V)	17A (8.5A)	2 Harmonised Tones	115	800-750	10	

Ratchet and Luggage Straps

750KG RATCHET STRAP & HOOKS

- 750Kg over centre tie down strap and buckle
- 50mm strap/buckle
- Strong polyester webbing with double 'J' hooks
- Ideally suited to box van lashing applications
- EN12195-2:2001
- Lashing capacity refers to load the strap can take measured in daN (Deca Newton)



Length	Break Force	Lashing Capacity	Code (Each)	Box Qty
5m	750Kg	375 daN	MP6075	25

2500KG RATCHET STRAP & HOOKS

- 38mm ratchet tie down
- Strong polyester webbing with double 'J' hooks
- Ideal for commercial use
- Reusable bag for storage
- Available in 2 lengths
- EN12195-2:2000



Length	Break Force	Lashing Capacity	Code (Each)	Box Qty
4.5m	2500Kg	1275 daN	MP606	20
6m	2500Kg	1275 daN	MP6062	20

5000KG RATCHET STRAP & HOOKS

- 50mm ratchet tie down
- Strong polyester webbing with double 'J' hooks
- Ideal for heavy duty commercial use
- EN12195-2:2001
- Available in 2 lengths



Length	Break Force	Lashing Capacity	Code (Each)	Box Qty
8m	5000Kg	2000 daN	MP61208	10
10m	5000Kg	2000 daN	MP61210	10

4000KG CAR TRANSPORTER LASHING STRAP

- 50mm car transporter lashing strap
- Strong polyester webbing with claw end fittings
- Ideal for vehicle recovery on trailers & recovery trucks
- Soft link strap and wear sleeve helps to protect wheels from scuffs and scratches



Length	Break Force	Lashing Capacity	Code (Each)	Box Qty
4m	4000Kg	2000 daN	MP61304	10

600KG RATCHET STRAP

- 25mm ratchet tie down strap
- Safe and easy to use
- Strong polyester webbing with quick release ratchet
- EN12195-2:2000
- GS/TUV Approved



Length	Break Force	Lashing Capacity	Code (Each)	Box Qty
4.5m	600Kg	250 daN	MP608	24

600KG RATCHET STRAP & HOOKS

- 25mm ratchet tie down strap with heavy duty 'S' hooks
- Safe and easy to use
- Strong polyester webbing with quick release ratchet
- EN12195-2:2000
- GS/TUV Approved



Length	Break Force	Lashing Capacity	Code (Each)	Box Qty
4.5m	600Kg	250 daN	MP607	24

600KG RATCHET STRAPS & HOOKS (PAIR)

- 25mm ratchet tie down straps with heavy duty 'S' hooks
- Safe and easy to use
- Strong polyester webbing with quick release ratchet
- EN12195-2:2001
- GS/TUV Approved



Length	Break Force	Lashing Capacity	Code (Each)	Box Qty
4.5m	600Kg	250 daN	MP6070	18

250KG LUGGAGE STRAP WITH CAM BUCKLE

- Strong 25mm polyester webbing with quick release cam buckle
- Safe and easy to use
- EN12195-2:2000
- GS/TUV Approved
- Supplied in singles or as a pair



Unit	Length	Break Force	Lashing Capacity	Code (Each)	Box Qty
Single	2.5m	250Kg	125daN	MP6071	48
Pair	2.5m	250Kg	125 daN	MP6072	40

Car Covers

CAR TOP COVERS

- Strong & lightweight water resistant car top covers ideal for frost and snow protection
- The water resistant fabric does not absorb moisture meaning that water, snow and frost can be shaken from the cover when it is removed
- Complete with 4 strong elasticated straps for a windproof secure fit
- Quick, easy to fit and takes up very little storage space when stored
- Available in 4 sizes to fit modern vehicles
- Handy storage bag for when not in use



Protects against;



Smog & Dust



Rain & Wind



Frost & Snow



UV Rays



High UV protection



Water resistant



Quick & easy to fit



Ideal winter protection



Birds



Leaves

Code (Each)	Vehicle Size	Approx. Dimensions (cm)	Box Qty
MP990	Small	L 283 x W 118 x H 54.5	10
MP992	Medium	L 325 x W 128 x H 57	10
MP991	Large	L 352 x W 128 x H 53	10
MP993	Extra Large	L 377 x W 129 x H 70	10

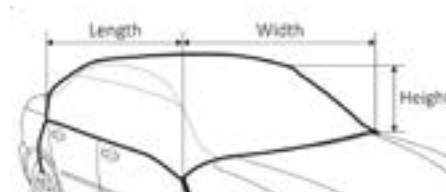

NOTE: All dimensions are approximate and for guidance only

Features include;



4 elasticated straps for a secure windproof fit.



Reinforced stitching for extra strength.



Fit tailored to most modern vehicle sizes.

BREATHABLE CAR COVERS

- Fully breathable water resistant covers ideal for long term protection in any environment
- The breathable material allows moisture to evaporate whilst still protecting the car from the outdoor elements
- The double stitched seam and adjustable straps are designed to withstand tough conditions yet light enough to be fitted and removed quickly
- Available in 4 sizes to fit modern vehicles
- Handy storage bag for when not in use



Protects against;



Smog & Dust



Rain & Wind



Frost & Snow



UV Rays



Birds



Leaves



High UV protection



Water resistant



Quick & easy to fit



Breathable material

Code (Each)	Vehicle Size	Approx. Dimensions (cm)	Box Qty
MP9851	Small	L 430 x W 160 x H 115	4
MP9861	Medium	L 450 x W 160 x H 116	4
MP9871	Large	L 490 x W 170 x H 116	4
MP9881	Extra Large	L 530 x W 190 x H 117	4

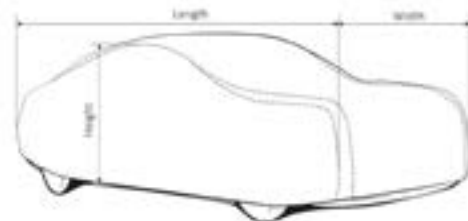

NOTE: All dimensions are approximate and for guidance only

Features include;



4 straps with buckles for a secure windproof fit.



Elasticated hem allows a tailored fit.



Double stitched seam for extra strength.

Car Covers

BREATHABLE MPV & SUV COVERS

- Fully breathable water resistant covers ideal for long term protection in any environment
- The breathable material allows moisture to evaporate whilst still protecting the car from the outdoor elements
- The double stitched seam and adjustable straps are designed to withstand tough conditions yet light enough to be fitted and removed quickly
- Available in 2 sizes to fit modern MPV & SUV vehicles
- Handy storage bag for when not in use



Protects against;



Smog & Dust



Rain & Wind



Frost & Snow



UV Rays



Birds



Leaves



High UV protection



Water resistant



Quick & easy to fit



Breathable material

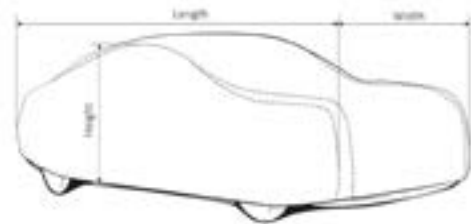

Code (Each)	Vehicle Size	Approx. Dimensions (cm)	Box Qty
MP9482	Medium	L 460 x W 190 x H 140	4
MP9483	Large	L 500 x W 210 x H 140	4

NOTE: All dimensions are approximate and for guidance only

Features include;



4 straps with buckles for a secure windproof fit.



Elasticated hem allows a tailored fit.



Double stitched seam for extra strength.

PREMIUM WATERPROOF CAR COVERS

- Fully waterproof covers designed for long term winter storage and protection against the toughest elements where absolute waterproofing is a must
- Designed with vents to reduce condensation build up and adjustable straps to ensure a secure fit in the harshest conditions
- Made from polyester Oxford 200D with waterproof PU coating
- Available in 4 sizes to fit modern vehicles
- Handy storage bag for when not in use



Protects against;



Smog & Dust



Rain & Wind



Frost & Snow



UV Rays



Birds



Leaves



High UV protection



Fully waterproof



Quick & easy to fit

Code (Each)	Vehicle Size	Approx. Dimensions (cm)	Box Qty
MP9331	Small	L 430 x W 160 x H 115	4
MP9332	Medium	L 450 x W 160 x H 116	4
MP9333	Large	L 490 x W 170 x H 116	4
MP9334	Extra Large	L 530 x W 190 x H 117	4

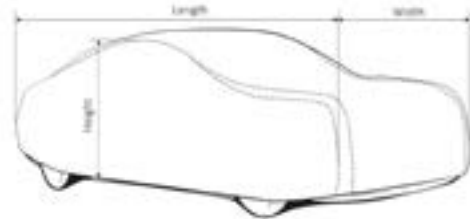

NOTE: All dimensions are approximate and for guidance only

Features include;



4 straps with buckles for a secure windproof fit.



Elasticated hem allows a tailored fit.

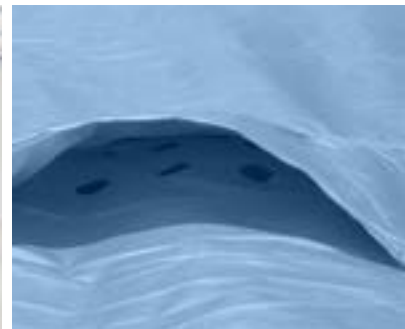

Air vents to reduce condensation build up.

Covers

UNIVERSAL NYLON SCOOTER COVER

- Water and UV resistant
- Ventilation panel
- Elasticated hem and tie
- Security strap to secure the cover to the vehicle
- Storage bag with straps for attaching to scooter



Code (Each)	Box Qty
MP937	10

REAR SPARE WHEEL COVER

- 4x4 spare wheel cover
- Easy to fit with elasticated band
- Protects wheel from weather damage
- Keeps wheel clean



Code (Each)	Tyre Diameter	Box Qty
MP94428	710mm (28")	10
MP94429	735mm (29")	10
MP94431	790mm (31")	10

DELUXE WINDSCREEN COVER

- Frost cover with carry pouch
- 1900 x 740mm
- Small and compact
- Snow and ice protection
- 100% nylon
- Easy to fit



Code (Each)	Box Qty
MP9890	50

Boot Liners

DELUXE UNIVERSAL CAR BOOT LINER

- Ideal for protecting the car boot floor when visiting the tip, garden centres and transporting pets
- Heavy duty water resistant polyester material
- Universal fit suitable for most vehicles
- W106xL97xH40cm overall
- Easy to fit and secure - comes with velcro strips, zips and elasticated straps
- Zipped rear panel can fold down to protect bumper and paintwork during loading and unloading
- Display boxed with euro slot

Protects against;



Dirt & grease



Oil & water



Food & drink



Code (Each)	Box Qty
MP6543	10

HEAVY DUTY PVC CAR BOOT LINER

- Protects your car boot from dirt, spills, animal hair and lingering odours
- Generous sizing - 140 x 110cm
- Trim to fit - cutter guidelines in the mat allow for easy trimming to fit the contour of your boot
- Easy to clean - can be swept or hosed down

Protects against;



Dirt & grease



Oil & water



Food & drink

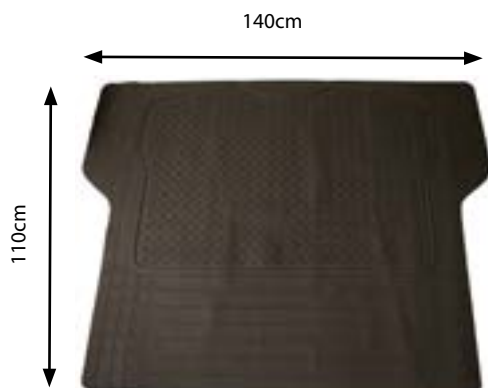

Code (Each)	Box Qty
MP6380	4

Seat Covers

HEAVY DUTY UNIVERSAL SEAT PROTECTORS

- Fully waterproof heavy duty nylon seat covers designed to protect your vehicle upholstery from all elements
- Complete with seat belt access and an elasticated base that ensures secure and easy fit
- Universal sizing suitable for cars, vans, MPV's, 4X4s and minibuses
- Easily wiped clean
- Can be used with armrests
- Not compatible with seat airbags



MP650



MP651



MP652/MP6525

Protects against;

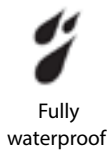

Code (Each)	Vehicles	Colour	Set Qty	Box Qty
MP650	Cars, vans, MPV's, 4x4's & minibuses	Grey	1 x single front cover	14
MP651	Cars, vans, MPV's, 4x4's & minibuses	Grey	1 x rear cover	10
MP652	Vans, MPV's, 4x4's & minibuses	Grey	1 x single front cover 1 x double front seat cover	10
MP6525	Vans, MPV's, 4x4's	Black	1 x single front cover 1 x double front seat cover	10

Features include;



Easy seat belt access.



Elasticated base ensures secure and easy fit.



Covers the headrest.

WATER RESISTANT UNIVERSAL CAR SEAT PROTECTORS

- Water resistant seat covers designed to protect your vehicle upholstery from all elements
- Complete with seat belt access and an elasticated base that ensures a secure and easy fit
- Universal sizing suitable for cars, vans, MPV's, 4x4s and minibuses
- Easily wiped clean
- Not compatible with seat airbags



Protects against;



Code (Each)	Vehicles	Colour	Set Qty	Box Qty
MP6508	Cars, vans, MPV's, 4x4's & minibuses	Grey	2 x single front cover	14
MP6518	Cars, vans, MPV's, 4x4's & minibuses	Grey	1 x rear cover	14

Features include;



Easy seat belt access.



Elasticated base ensures secure and easy fit.



Covers the headrest.

'Vision Pro' Flat Wiper Blades & Kit

'VISION PRO' FLAT WIPER BLADES & KIT

- OEM quality
- Simple & easy to fit
- Universal fit
- Natural soft rubber
- Flat design with precision-tensioned, dual steel spring for uniform pressure along the whole blade
- Aerodynamic design reduces wind lift at speed
- Precision cut wiping edge for maximum clearance of water from the windscreen
- Resistant to heat & cold
- Note – each pack contains single blades only
- Online fitting instructions are available by scanning the QR code on the packaging

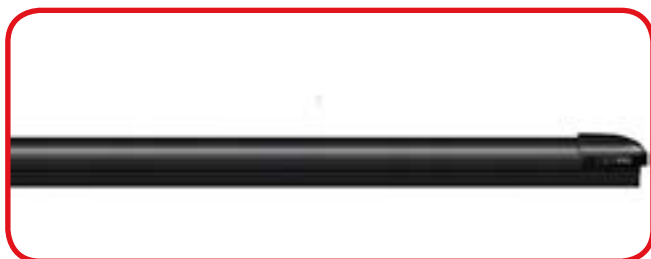

Display Pack	Size
MP15003	15" 380mm
MP15004	16" 410mm
MP15005	17" 430mm
MP15006	18" 450mm
MP15007	19" 480mm
MP15008	20" 510mm
MP15009	21" 530mm
MP15010	22" 550mm
MP15011	23" 580mm
MP15012	24" 610mm
MP15013	26" 650mm
MP15014	28" 700mm



Car Mats

All of our car mats are universal fitting giving unrivalled protection to your car's original carpets from dirt, mud, rain, snow, pet hair and salt corrosion. The anti-slip backing helps prevent movement whilst the high quality materials ensure the mats are durable, hard wearing and suitable for all seasons. Supplied with display header and hook to hang on a stand in store. Available in a variety of designs and budgets to suit your customer's needs. Only available in outer box quantities.

PVC CAR MATS

Style	Colour	Dimensions (cm)	Trimable	Code (Each)	Box Qty
Heavy duty	Black	L 70.3 x W 44.3	Yes	MP6337	6
Universal	Black	L 60 x W 40.5	Yes	MP6373	12
Heavy duty	Black/blue	L 70.5 x W 48.5	Yes	MP6353	6
Heavy duty	Black/grey	L 70.5 x W 48.5	Yes	MP6354	6

Protection

Trim to fit

Washable

Non-slip

COMBINED PVC & CARPET CAR MATS

■ PVC car mats with carpet inserts

Style	Colour	Dimensions (cm)	Trimable	Code (Each)	Box Qty
Heavy duty	Black	L 71 x W 45.5	Yes	MP6304	6
Luxury	Black	L 71 x W 48	Yes	MP6343	6
Luxury	Grey	L71 x W 48	Yes	MP6345	6

Non-slip

Protection

Trim to fit

Welding

MIG WIRE

■ Quality wire for use with most mig welders

Mig Wire	Code	Box Qty
0.6mm Mild Steel 0.7Kg Spool	MP560	18
0.8mm Mild Steel 0.7Kg Spool	MP561	18
0.8mm Stainless Steel 0.7Kg Spool	MP562	20
0.6mm Mild Steel 5Kg Spool	MP565	1
0.8mm Mild Steel 5Kg Spool	MP566	1
0.8mm Mild Steel 15Kg Spool	MP568	1
Flux Cored	Code	Box Qty
0.9mm Flux Cored Wire 0.4Kg Spool	MP524	20
0.8mm Flux Cored Wire 0.4Kg Spool	MP526	20
0.9mm Flux Cored Wire 0.9Kg Spool	MP525	20
0.8mm Flux Cored Wire 0.9Kg Spool	MP527	20



CONTACT TIPS 5MM THREAD (M5)

■ Tips for M14 torches

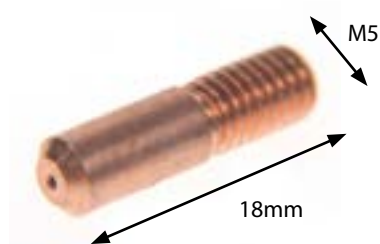

	Code
0.6mm x 18mm M5 thread x 5 display packed	MP551
0.6mm x 18mm M5 thread bulk (min order 20)	MP551B
0.8mm x 18mm M5 thread x 5 display packed	MP552
0.8mm x 18mm M5 thread bulk (min order 20)	MP552B

CONTACT TIPS 6MM THREAD (M6)

■ Tips for M15 torches

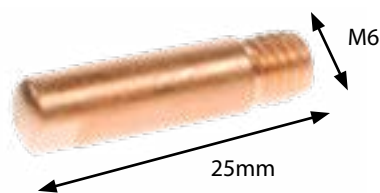

	Torch	Code
0.6mm x 25mm M6 thread x 5 display packed	M14/15	MP531
0.6mm x 25mm M6 thread bulk (min order 20)	M14/15	MP531B
0.8mm x 25mm M6 thread x 5 display packed	M14/15	MP532
0.8mm x 25mm M6 thread bulk (min order 20)	M14/15	MP532B
1.0mm x 28mm M6 thread x 5 display packed	M25	MP534
1.0mm x 28mm M6 thread bulk (min order 20)	M25	MP534B

GAS CUPS SCREW ON TYPE

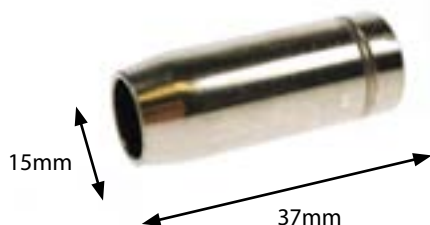

	Code
Conical gas cup x 2 display packed	MP553
Conical gas cup bulk (min order 5)	MP553B

GAS CUPS PUSH ON TYPE

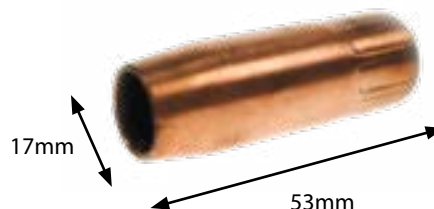

	Code
Conical gas cup x 2 display packed	MP693
Conical gas cup bulk (min order 5)	MP693B

DISPOSABLE GAS CYLINDERS

Disposable gas cylinders are ideal when portability is essential or gas usage is low; suitable for most makes of mini mig welders.

	Code	Box Qty
CO ² 600g cylinder for welding mild steel.	MP555	12
ARGON/CO ² mix cylinder for welding stainless steel and mild steel. Welding duration approx 20 minutes. ARGON/CO ² mixtures will usually require lower power settings and give a steadier arc and smoother weld appearance than CO ² . Therefore better performance is available from most machines when using ARGON/CO ² gas.	MP556	12
ARGON cylinder for welding aluminium. Welding duration approx 20 minutes.	MP557	12



FLIP UP HEAD MASK

- Head and sweat band
- Fully assembled
- Conforms to EN175
- Complete with anti-spatter, dark and clear lens
- 4¼" x 2" lens



	Code
Head mask	MP114

TYRE INFLATION GUN C/W CLIP CONNECTOR

- Durable die-cast metal body
- Robust pressure gauge with two scales 0-220 psi & 0-15 Bar
- Clip on connection with 350mm rubber hose
- ¼ BSP fitting



Code
MP780

WELDING GAUNTLETS

- Leather lined gloves
- CE marked CAT II
- Fire resistant



Display Pack	Bulk Pack
MP156	MP156B

TYRE INFLATION GUN C/W PUSH-ON CONNECTOR

- Durable die-cast metal body
- Robust pressure gauge with four scales 0-220 psi, 0-15 Bar, 0-15Kg/cm² & 0-1500 kPa
- Tyre chuck connection with 350mm rubber hose
- ¼ BSP fitting



Code
MP7805

Workshop Essentials

AIR BLOW GUNS

■ Useful for removing dust, swarf and residue from inaccessible or hidden areas. The trigger allows you to regulate the amount of air flow giving you greater control. Constructed from tough nylon plastic complete with steel nozzle.



Nozzle	BSP Fitting	Code
150mm	¼"	MP7812

HAND GREASE GUN

- Heavy duty manual grease gun
- 3 way filling operation - standard 400g cartridge, suction or bulk fill up to 500cc
- Two delivery tubes included - angled steel tube and flexible tube



Code
MP788

UNDERBODY COATING GUN

- Ideal for applying many types of coatings including anti-stone chip, Schutz, underbody sealant and wax-oil to help protect from rust corrosion
- Air pressure 3-8 bar / 45-120 psi
- Max pressure 10 bar / 150 psi
- Supplied with 60cm wax injector probe
- Standard ¼" BSP fitting



Code
MP782

SPRAY GUNS

A range of high quality spray guns designed for use in a variety of applications including car body spraying, wheel refurbishment and covering large surface areas quickly and with an even coating.

All of our spray guns feature pressure sensitive triggers, air screws and fully adjustable spray patterns for maximum control. The robust brass air caps and stainless steel needle and nozzle ensures for long-life performance and ¼" BSP fitting for universal fitment.

MP7855 Gravity Fed



MP7865 HVLP Gravity Fed



	Nozzle	Max Air Pressure	Air Consumption	Cup Capacity	Code (Each)
Economy	1.5mm	45 PSI	7CFM	600ml	MP7855
Professional	1.7mm	45 PSI	15CFM	600ml	MP7865

Air Hoses & Fittings

10M RUBBER AIR HOSE

- Professional heavy duty 8mm rubber air hoses pre-fitted with standard 1/4" BSP female swivel nuts
- Max working pressure 300 psi / 20 bar
- Conforms to ISO 239812



Code
MP78710

7.62M/25FT COILED UPVC AIR HOSE

- High strength, flexible UPVC hose; recoils when slack to help keep work areas tidy
- All hoses are fitted with standard 1/4" BSP fitted swivel nuts
- Max working pressure 200 psi
- Resistant to oil, grease and most similar contaminants
- Suitable for MP782, MP7855, MP786 and MP7865



Code
MP78707

1/4" STANDARD COUPLING AIR LINES

	Display Pack
Male	MP74601
Female	MP74602



1/4" SLIM COUPLING AIR LINES

	Display Pack
Male	MP74603
Female	MP74604



1/4" QUICK CONNECT ADAPTOR AIR LINES

	Display Pack
Female	MP74606
Male	MP74607



Trailer Lighting & Towing

Our Trailer Lighting and Towing catalogue includes over 120 pages of new products, more product information and latest images and drawings. It includes all of the following product ranges:

Towing Electrics

Cable, Cable Accessories, Extension Leads & Junction Boxes

Plugs & Sockets

Conversion Adaptors, 12 & 24V Plugs & Sockets

Towbar Wiring

Towbar Wiring Kits, Socket Mounting Plates, Relays, Towbar Testers

Towing Hardware

Towballs, Ball & Pin Hitches & Towing Hardware

Trailer Lighting Harness

Trailer Lighting Solutions, SuperSeal Harness, Radex & AJ.BA Harnesses & Lamps

LED Vehicle Lamps

Markers, Outline Markers, Combination, Reverse, Fog & Numberplate Lamps

Bulb Vehicle Lamps

Markers, Outline Markers, Combination, Reverse, Fog & Numberplate Lamps

Trucklite

Trailer Lighting Boards

Trailer Lighting Pods, LED, LED Varivolt, Standard, Cycle Carrier Boards

Reflectors

Beacons & Work Lamps

Interior Lamps

LED & Bulb



Trailer Servicing, Parts & Accessories

Our Trailer Servicing, Parts and Accessories catalogue is a one-stop shop for all trailer builders and service centres. It includes all of the following product ranges:

Couplings

Bellows, Dampers, Breakaway Cables, Secondary Couplings, Drawbar & Coupling Accessories

Jockey Wheels

Replacement Jockey Wheels, Prop Stands, Jacks & Jockey Wheel Clamps

Brakes

Brake Shoe Axle Sets, Brake Cables, Brake Parts

Bearings

Bearing Kits, Bearings, Hub Caps, Wheel Studs, Bolts & Nuts

Suspension Units

Wheels & Tyres

Trailer Mudguards

Trailer Fixtures & Fittings

U-Bolts

Winches

Boat Rollers

Launch Trolley Wheels

Trailer Security

Stronghold & Maypole hitchlocks & wheel clamps



Why choose Stronghold Security products?

Designed in the UK and manufactured to the highest standards, Stronghold is a leading name in vehicle security solutions. The range includes wheel clamps and hitchlocks intended for securing caravans, motorhomes and trailers. Created in 1987 Stronghold products have continually been improved and developed to meet the demands of an ever changing market place. We provide competitive products that give the consumer the right level of security at the right price and insuring peace of mind. Our products are inventive and feature creative new approaches to vehicle security.

Our goal is to manufacture products that meet the consumer's expectations of;

- Quality
- Insurance Approval
- Independent testing by recognised third party test companies
- User friendly and ease of fit - pictorial instructions and fitting videos available
- After sales support
- Spares availability



In response to these expectations our Stronghold products commonly feature;

- Robust anti-saw hardened steel construction
- Lightweight and compact designs
- Registered product designs with patented high security pick-free locks, unique to Stronghold
- Sold Secure certification, recognised by UK insurance companies
- 5 year manufacturing defect warranty
- Online product registration
- Fitting videos and colour pictorial fitting instructions
- Full after sales technical support
- Products supplied with three keys, but a spare key cutting service is available (please note that the key code needs to be recorded on the instructions provided)
- Keyed alike also available, (special order only) enabling you to secure several vehicles with the same key
- Storage case with most products

We are committed to ensuring that all Stronghold products pass stringent security tests not only in the UK but also in Europe.

5 Year Warranty

All Stronghold products carry a 12 month manufacturing defect warranty.

Consumers can upgrade the 12 month warranty to 5 years, free of charge, if within one month of purchase they;

- Complete and return the enclosed warranty card to us, or
- Register the purchase with us online at www.stronghold-security.com. Follow the link to "Register your product here".



Sold Secure

Many of the Stronghold products carry Gold Sold Secure Approvals that are recognised by UK insurance companies. Sold Secure is an independent test company for the assessment of security products. They are administrated by the Master Locksmith Association. They test security products within strict criteria to ensure the products are designed and manufactured to the highest standards. Annual re-testing ensures these standards are maintained. Our products can withstand prolonged attack tests to give your customer peace of mind.



SCM / VbV

For customers in Europe, SH5412, SH5414 and SH5415 are tested and approved to the MP03 standard from SCM / VbV in the Netherlands. The VbV is an association of Dutch insurers that create quality standards for vehicle security systems. SCM / VbV approvals for caravan and trailer mechanical security devices to MP03 standard, are recognised by Dutch and other international insurers.



Secured by Design

Secured by Design member company status is awarded to companies producing security products that pass standards and tests nominated by the police service. The standards and related tests must demonstrate the product effectiveness in preventing or reducing crime, usually by resistance to physical attack. Many Stronghold products have Secured by Design status.



Dedicated Website

We have recently launched a brand new Stronghold dedicated website where you will find more information, videos, images and be able to locate dedicated Stronghold stockists in a specific area. Full warranty terms and FAQs can be viewed on the website www.stronghold-security.com.

Please contact our customer services department for any technical support or spare requirements.

Please note that Stronghold products are only available in box quantities.

We have images and fitting videos available for your website or catalogue. We also have available A5 leaflets that can be used in-store to promote the products to the consumer. Please contact our marketing department for more information.

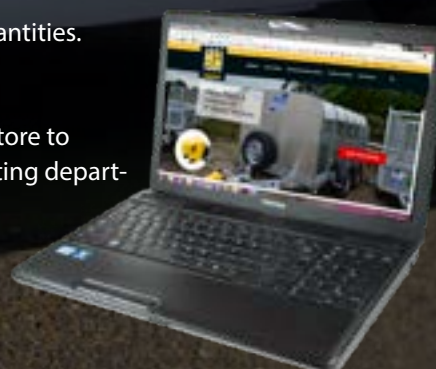

Hitchlocks

We supply a range of hitchlocks for caravans and trailers security. Hitchlocks are a visible deterrent and can prevent your caravan or trailer from being stolen. Stronghold hitchlocks are Sold Secure Gold Approved, meaning they are tested to stringent attacks to stop an opportunist thief. Our locks cover the hitch and make it difficult for thieves to attach a caravan and tow it away. This gives you peace of mind when your caravan is on the campsite or left in storage.

The below guide shows exactly which hitch models our hitchlocks fit:

Manufacturer	Model	SH5412	SH5414	SH5415	SH5417	SH5410
ALKO	1. AK130	●				
	2. AK160	●				
	3. AKS1300	●				
	4. AKS2004	●				
	5. AKS3004	●				
Avonride	6. 575003			●		
	7. 575004			●		
	8. 575005			●		
	9. 575008			●		
Bradley	10. HU3				●	
	11. HU12				●	
BPW	12. ISC ZKAS		●			
Knott	13. K7.5					●
	14. K14					●
	15. KK14					●
	16. KQ14					●
	17. K20					●
Steelpress	18. ZSK-750					●
	19. ZSK-1300					●
	20. ZSK-1700					●
	21. ZSK-2000					●
	22. BC2300					●
23. BC3000-1					●	
Winterhoff	24. WS3000		●			
	25. WW8					●
	26. WW150					●



Scan the code to watch the fitting video!



Hitchlock

for ALKO Hitches

SH5412

- High security patented locking system
- Can be used when a car and caravan are parked coupled together to provide security in both hitched or unhitched situations
- Approved to Sold Secure Gold standard for caravans
- VbV/SCM MP03 Approved in the Netherlands
- Approved by Secured by Design
- Immobilises hitch to prevent tow-away theft
- Fitted in under 10 seconds, scan the QR code for video
- The strong and robust high visibility yellow hardened steel casing with anti-saw features covers the fixing bolts of the hitch to protect it from being stolen
- Water and corrosion resistant
- Lightweight and compact
- High security pick-free locks have thousands of possible key combinations and are supplied with 3 keys, plus a key identity tag
- Supplied in a retail display box with colour pictorial instructions
- Handy storage bag included



Kit Contents:

- Hitchlock
- Locking bolt body
- Locking bolt lock holder with three keys
- Security ball - SH54126B
- Fitting instructions and warranty card

Code (Each)	Weight	Box Qty
SH5412	3Kg	4



Fits a wide range of ALKO hitches including:

AK130



AK160



AKS1300



AKS2004



AKS3004



Scan the code to watch the fitting video!



Hitchlock

for **Winterhoff & BPW**
Stabiliser Hitches

SH5414

- High security patented locking system
- Can be used when a car and caravan are parked coupled together to provide security in both hitched or unhitched situations
- Approved to Sold Secure Gold standard for caravans
- VbV/SCM MP03 Approved in the Netherlands
- Approved by Secured by Design
- Immobilises hitch to prevent tow-away theft
- Fitted in under 10 seconds, scan the QR code for video
- Strong and robust hardened steel construction
- Water and corrosion resistant
- Lightweight and compact
- High security pick-free locks have thousands of possible key combinations and are supplied with 3 keys, plus a key identity tag
- Supplied in a retail display box with colour pictorial instructions
- Handy storage bag included



Kit Contents:

Set of three keys
Security ball - SH54126B
Left-hand cheek with lock pin
Right-hand cheek with lock holder
Fitting instructions and warranty card

Code (Each)	Weight	Box Qty
SH5414	2.5Kg	4

Fits Winterhoff WS3000 and BPW ISC (ZKAS) stabiliser couplings:

WS3000



ISC ZKAS



Scan the code to watch the fitting video!



Hitchlock

for Avonride Hitches

SH5415

- High security patented locking system
- Suitable for many Ifor Williams trailers and horse boxes
- Can be used when a car and caravan are parked coupled together to provide security in both hitched or unhitched situations
- Allows use of Avonride integral lock
- Approved to Sold Secure Gold standard for trailers
- VbV/SCM MP03 Approved in the Netherlands
- Approved by Secured by Design
- Immobilises hitch to prevent tow-away theft
- Fitted in under 10 seconds, scan the QR code for video
- The strong and robust high visibility yellow hardened steel casing with anti-saw features covers the fixing bolts of the hitch to protect it from being stolen
- Water and corrosion resistant
- Lightweight and compact
- High security pick-free locks have thousands of possible key combinations and are supplied with 3 keys, plus a key identity tag
- Supplied in a retail display box with colour pictorial instructions
- Handy storage bag included



Kit Contents:

- Hitchlock cover
- Locking bolt body
- Locking bolt lock holder with three keys
- High security plastic hitch ball - SH54126B
- Fitting instructions and warranty card

Code (Each)	Weight	Box Qty
SH5415	4.5Kg	4



Fits most 50mm Avonride cast coupling heads including:

575003



575004



575005



575008



Scan the code to watch the fitting video!



Hitchlock

for **Bradley Autohead Hitches**

SH5417

- High security patented locking system
- Widely used on plant trailers
- Can be used when a car and caravan are parked coupled together to provide security in both hitched or unhitched situations
- Approved to Sold Secure Gold standard for caravans and trailers
- VbV/SCM MP03 Approved in the Netherlands
- Approved by Secured by Design
- Immobilises hitch to prevent tow-away theft
- Fitted in under 10 seconds, scan the QR code for video
- Strong and robust hardened steel construction
- Water and corrosion resistant
- High security pick-free locks have thousands of possible key combinations and are supplied with 3 keys, plus a key identity tag
- Retail friendly plastic case included, also ideal for storage



Kit Contents:

- Hitchlock cover
- Locking bolt body
- Locking bolt lock holder with three keys
- High security plastic hitch ball
- Fitting instructions and warranty card

Weight	Box Qty	Code (Each)
4.3Kg	4	SH5417

Fits HU3, HU12 and D201C Bradley Autohead Hitches:

HU3



HU12





Scan the code to watch the fitting video!



Strongbox Ultra

for Knott, Steelpress & Winterhoff Pressed Steel Hitches

SH5410



- High security patented locking system
- Suitable for braked and unbraked trailers, horseboxes, car transporters etc
- Approved to Sold Secure Gold standard for caravans and trailers
- Approved by Secured by Design
- Patent pending design
- Lock fits between handle and main coupling body to completely block coupling use
- Immobilises hitch to prevent tow-away theft
- Fitted in under 10 seconds
- Strong and robust hardened steel construction
- High security pick-free locks have thousands of possible key combinations and are supplied with 3 keys, plus a key identity tag
- Storage bag included
- Supplied in a retail display box with colour pictorial instructions



Kit Contents:

- Hitchlock cover
- Locking bolt body
- Locking bolt lock holder with three keys
- Plastic hitch ball & tee assembly - SH54106B
- Fitting instructions and warranty card
- Storage bag

Weight	Box Qty	Code (Each)
5.1Kg	4	SH5410

Fits Knott, Steelpress & Winterhoff pressed steel hitches:

Knott



Steelpress



Winterhoff



See page 64 for full application list





Towing Eye Lock

for 40/50mm towing eyes

SH5420

- High security patented locking system
- Fits 40 to 50mm towing eyes, commonly used on plant equipment such as compressors and water bowsers
- Also suitable for use on commercial trailers, lighting towers and mobile catering
- Approved to Sold Secure Gold standard for caravans and trailers
- VbV/SCM MP03 Approved in the Netherlands
- Approved by Secured by Design
- Body is one piece steel construction
- Lock blocks access, to stop vehicle coupling and theft
- Fitted in under 10 seconds
- Strong and robust hardened steel construction
- Water and corrosion resistant
- Lightweight and compact
- High security pick-free locks have thousands of possible key combinations and are supplied with 3 keys, plus a key identity tag
- Supplied in a retail display box with colour pictorial instructions
- Handy storage bag included



Kit Contents:
 40/50mm towing eye cover
 Locking bolt body
 Locking bolt lock holder with three keys
 Fitting instructions and warranty card

Code (Each)	Weight	Box Qty
SH5420	2Kg	4

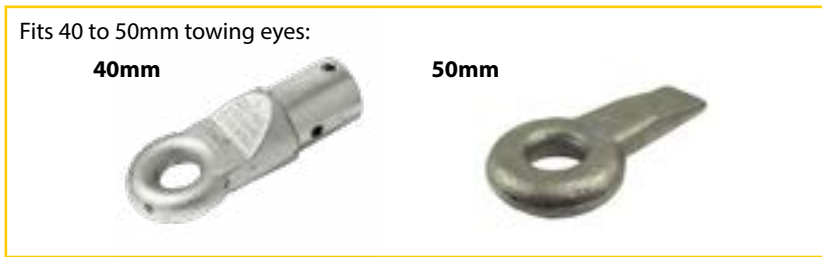

Wheel Clamps

We supply a range of wheel clamps to suit different size tyres on a caravan, trailer or motorhome. Wheel clamps are an instant visual deterrent against an opportunist thief. Whether you have alloy or steel wheels we have a wheel clamp for you. Our wheel clamps designed for caravan security are Sold Secure Gold Approved, meaning they are tested to stringent timed attacks.

The below guide can help you to identify how to work out a suitable wheel clamp for your tyre size. There are three pieces of information that you need to know regarding your wheel to be able to identify the most suitable wheel clamp.

1. Measure the wheel rim
2. Measure the tyre width
3. Do you have an alloy or steel wheel?
4. Use the chart below to find the most suitable wheel clamp for your requirements

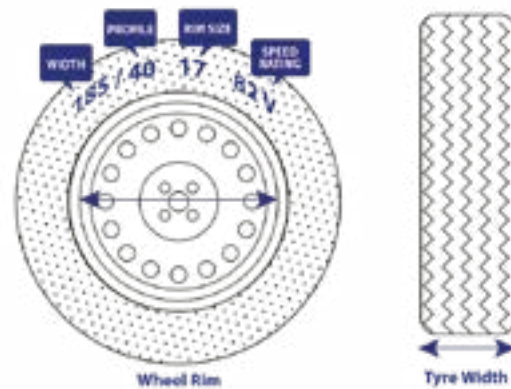

Part no.	Suitable for	Wheel rim	Tyre width	Weight	Wheel Type
SH5431	Caravans & trailers	12-14"	155-190mm	4.8Kg	Steel
SH5432	Caravans	Universal	Universal	3.4Kg	Alloy
SH5436	Caravans	13-15"	165-205mm	8.51Kg	Alloy
SH5438	Caravans & Trailers	Universal	Up to 265mm	7.1Kg	Both
SH5439	Cars, 4x4's, motorhomes & camper vans	Universal	Up to 265mm	7.1Kg	Both
SH5451	Trailers & Cars	12-13"	Up to 165mm	8.9Kg	Both
SH5452	Caravans, trailer tents horse boxes	13-15"	175-195mm	9.6Kg	Both
SH5456	Caravans & motorhomes	15-18"	205-225mm	10Kg	Both

Scan the code to watch the fitting video!



Apex

Triangular Wheel Clamps

- High security patented locking system
- Available in 3 sizes and suitable for cars, caravans, trailers, trailer tents, horse boxes, vans and motorhomes
- Approved to Sold Secure Gold standard for cars, caravans and trailers
- Approved by Secured by Design
- Highly visible deterrent
- Versatile heavy duty triangular wheel clamp
- Fully adjustable (set once only) for wheel diameter
- Covers wheel nuts, wheel trims and alloy wheels
- Protective rubber on back plate to prevent damage to the wheel when fitted
- Very easy to fit and in under a minute, no tools required for assembly
- Patented design with unique locking front plate
- Strong and robust hardened steel construction
- Water and corrosion resistant
- Lightweight and compact
- High security pick-free locks have thousands of possible key combinations and are supplied with 3 keys, plus a key identity tag
- Supplied in a retail display box with colour pictorial instructions
- Trailer application list available upon request



Kit Contents:

- Wheel clamp top plate
- Wheel clamp back plate
- Top arm
- 2 x adjustable arms
- Locking adaptor
- Lock with three keys
- Fitting instructions and warranty card



Code (Each)	Tyre Width	Description	Tyre Diameter	Box Qty
SH5451	Up to 165mm	12" - 13" wheel clamp	Min: 504mm - Max: 704mm	2
SH5452	175 - 195mm	13" - 15" wheel clamp	Min: 504mm - Max: 704mm	2
SH5456	205 - 225mm	15" - 18" wheel clamp	Min: 618mm - Max: 818mm	2



Scan the code to watch the fitting video!



Strongarm

Wheel Clamp

SH5431

- High security patented locking system
- Ideal for caravans and trailers with steel wheels
- Fits 12"-14" wheel rims with tyre sizes 155mm to 190mm
- Prevents tow-away theft by preventing wheel rotation
- Approved to Sold Secure Gold standard for caravans and trailers
- Approved by Secured by Design
- Lightweight and compact design
- Easily fitted in under 60 seconds
- Includes 2 x M12 x 1.5mm pitch wheel bolts and three keys
- Specifically designed for steel wheels
- Strong and robust hardened steel construction
- Locks onto the wheel hub instead of over the tyre
- High security pick-free locks have thousands of possible key combinations and are supplied with 3 keys, plus a key identity tag
- Supplied in a retail display box with colour pictorial instructions



Kit Contents:

Wheel clamp
2 x M12 x 1.5mm pitch wheel bolts
Lock with three keys
Fitting instructions and warranty card

Code (Each)	Weight	Box Qty
SH5431	4.8Kg	4



Scan the code to watch the fitting video!



Protector

Wheel Clamp

SH5432

- High security patented locking system
- Ideal for caravans alloy wheels
- Universal fit - not restricted by tyre size or width
- Prevents tow-away theft by stopping wheel rotation as the locking arm comes into contact with the suspension or bodywork
- Approved to Sold Secure Gold standard for caravans and trailers
- Approved by Secured by Design
- Lightweight and compact design
- Yellow protective cap protects lock from dirt and water
- Foam protection to lock bar and prevent damage to wheels
- Easily fitted in under 60 seconds
- Includes 1 x (M12 x 30mm) hexagon cap screw and three keys
- Strong and robust hardened steel construction, can't be cut off
- For ease of fitting the locking arm can be passed through any convenient hole in the rim that allows the lock body to be fitted on the replacement wheel bolt
- High security pick-free locks have thousands of possible key combinations and are supplied with 3 keys, plus a key identity tag
- Replacement or additional wheel bolts available - SH54364B
- Supplied in a retail display box with colour pictorial instructions



Kit Contents:

- Replacement M12 x 1.5 wheel bolt
- M12 x 30mm hexagon cap screw and key
- Locking arm
- Lock body
- Lock assembly & 3 keys
- Yellow lock cover cap
- Fitting instructions & warranty card

Code (Each)	Weight	Box Qty
SH5432	3.4Kg	2



Scan the code to watch the fitting video!



Alloy Wheel Clamp

SH5436

- High security patented locking system
- Ideal for caravans
- Fits 13"-15" wheel rims with tyre sizes 165mm to 205mm
- Prevents tow-away theft by preventing wheel rotation
- Approved to Sold Secure Gold standard for caravans and trailers
- Approved by Secured by Design
- Lightweight and compact design
- Easily fitted in under 60 seconds
- Includes 2 x M12 x 1.5mm pitch wheel bolts and three keys
- Specifically designed for steel wheels
- Water and corrosion resistant
- Strong and robust hardened steel construction
- Specifically designed for alloy wheels
- Locks onto the wheel instead of over the tyre
- High security pick-free locks have thousands of possible key combinations and are supplied with 3 keys, plus a key identity tag
- Supplied in a retail display box with colour pictorial instructions



Kit Contents:

'U' shaped wheel clamp
Lock with three keys
10mm allen key
M12 x 30mm socket headed screw with hexagon key
2 x M12 x 1.5mm pitch wheel bolt
Fitting instructions and warranty card

Code (Each)	Weight	Box Qty
SH5436	6.1Kg	2



Scan the code to watch the fitting video!



Atlas

Wheel Clamps

- High security patented locking system
- SH5438 ideal for caravans and trailers & SH5439 ideal for cars, 4x4s, motorhomes & camper vans
- Fits alloy and steel wheels with tyres up to 265mm wide
- Prevents tow-away theft by preventing wheel rotation
- Approved to Sold Secure Gold standard for caravans and trailers
- Approved by Secured by Design
- Lightweight and compact design
- Easily fitted in under 60 seconds
- Includes 2 x (M12 x 1.5) Stronghold Sold Secure Gold Approved locking wheel bolts and key (only SH5438)
- Additional locking wheel bolts available - SH7662
- Robust 'anti-drill' hardened steel construction
- Durable PVC coating prevents damage to wheel rims
- Protective cap protects lock from dirt and water ingress
- Water and corrosion resistant
- Strong and robust hardened steel construction
- High security pick-free locks have thousands of possible key combinations and are supplied with 3 keys, plus a key identity tag
- Supplied in a retail display box with colour pictorial instructions



Kit Contents:

2 x M12 x 1.5 high security, Sold Secure locking wheel bolts and key (only SH5438)
Front arm
Rear arm
Lock assembly and three keys
Lock cover
Fitting instructions and warranty card

Code (Each)	Weight	Box Qty
SH5438	4.95Kg	2
SH5439	4.95Kg	2





Stronghold Plastic Security Ball

- Plastic security ball for hitchlocks
- Suitable for - SH5412/SH5414/SH5415, or for use in conjunction with other Stronghold hitchlocks
- Also suitable for other 'branded' security products
- Allows operation of stabiliser or hitch handle mechanism enabling the security product to be fitted



Code (Each)	Display Pack (Single)	Box Qty
SH54126B	SH54126	10

Stronghold Locking Wheel Bolts

- Stronghold THATCHAM & Sold Secure Gold Approved locking wheel bolts
- Heavy duty toughened rotary ring for extra security
- Anti-drill
- Suitable for trailers & caravans
- Suitable for steel or alloy wheels



	Code (Each)
M14 x 23mm x 1.5 (Pack of 4)	SH7665
M12 x 23mm x 1.5 (Pack of 4)	SH7664
M12 x 23mm x 1.5 (Pack of 2)	SH7662

Maypole Locking Wheel Nuts

- High security locking wheel nuts for trailers and caravans
- Supplied in a pack of 2
- Spare keys available by special order
- 3/8 UNF nuts suitable for many UK light trailers
- M10 x 1.25 nuts suitable for many Continental light trailers including Erde & Daxara to 148
- Suitable for steel or alloy wheels



	Code (Each)
3/8 UNF Nuts	MP7651
M10 x 1.25 Nuts	MP7655

Maypole Locking Wheel Bolts

- High security locking wheel bolts for trailers and caravans
- Supplied in a pack of 2
- Spare keys available by special order
- M12 x 1.5 bolts suitable for many caravans and heavy trailers - MP7661
- Suitable for steel or alloy wheels



	Code (Each)
M12 x 1.5 Bolts	MP7661
M12 x 24.5mm x 1.5 Bolts	MP7663B

Maypole Security

A wide range of security devices including: parking posts, steering wheel locks and hitchlocks.



STEERING WHEEL LOCK

- Additional physical security to deter electronic theft of modern vehicles
- Universal fit for steering wheels up to 43cm (17") - right hand drive vehicles only
- Highly visible
- Compact and lightweight design - easy to use and store
- Fitted and removed in seconds
- Strong and robust steel construction
- Includes anti-drill integral lock
- Anti-saw bar
- Restricts access to air bag / fits over to protect from theft
- Easily stored in a footwell or under a seat when not in use
- Suitable for cars, vans, motorhomes etc.
- Unique design to Maypole



Code (Each)	Weight	Box Qty
MP5494	2.43Kg	4



UNIVERSAL STEERING WHEEL LOCK

- Additional security against modern day vehicle theft
- Highly visible deterrent, preventing wheel rotation
- Soft liner prevents scratching of the steering wheel
- Compact and lightweight design - easy to use and store
- Fitted and removed in seconds
- Strong and robust steel construction
- Heavy duty lock
- Suitable for cars and vans etc.



Code (Each)	Weight	Box Qty
MP9045	1.3Kg	6

DOUBLE HOOK STEERING WHEEL LOCK

- Universal fit for steering wheels up to 39cm
- Additional vehicle security
- Highly visible
- Strong and robust steel construction
- Restricts access to air bag
- Compact and lightweight design - easy to use and store
- Fitted and removed in seconds
- Suitable for cars and vans etc.



Code (Each)	Weight	Box Qty
MP9041	1.3Kg	12

HEAVY DUTY VAN DOOR LOCK

- Anti-pick lock with 2 keys
- 2Kg heavy duty
- Rust resistant chrome plated hasp and fittings
- Suitable for: vans, sheds and garages
- Supplied with 6x8mm fixing bolts



Code (Each)	Weight	Box Qty
MP908	2Kg	10



CAR KEY SIGNAL BLOCKER (PAIR)

- Wireless car key blocker (pair)
- Protects against wireless car theft
- Phone signal blocker
- Card theft blocker
- Twin pack
- Scan the QR code below to see how important it is to use a signal blocker to prevent theft of modern day vehicles



Code (Each)	Box Qty
MP9046	400



HITCHLOCK FOR ALKO HITCHES

- Fits ALKO hitches - AK130, AK160, AKS1300, AKS2004 and AKS3004
- Immobilises hitch to prevent tow-away theft
- Highly visible deterrent
- Strong and robust
- Lightweight and compact design (only 1.7kg)
- Insurance approved
- Easily fitted in under 10 seconds
- Multi purpose use - can be used hitched or unhitched
- Fitting instructions included
- Can be used with Stronghold security dummy ball SH54126 (not supplied)



Code (Each)	Weight	Box Qty
MP956	1.89Kg	6



STRONGBOX HITCHLOCK

- Ideal for braked trailers fitted with ALKO, Steelpress and Knott pressed steel hitches
- Lightweight and user friendly patented design
- For hitches on straight drawbar only (Not 'A' frames)
- Fits hitched* or unhitched (*Swan neck and ALKO style towballs only)
- Multipurpose use - can be used hitched or unhitched
- Strongbox features an anti prising lip
- High security lock with anti-drill feature
- Strong and robust



Code (Each)	Weight	Box Qty
MP5411	3.4Kg	4

UNIVERSAL HITCHLOCK

- Fits most standard 50mm couplings
- Case hardened 12mm steel bar
- Prevents 'towaway theft'
- Quick & easy to use
- Supplied with two keys
- MP953B is supplied in a plain white box suitable for online retailers



Code (Each)	Display Pack	Weight	Box Qty
MP953B	MP953	1Kg	8

UNIVERSAL COUPLING LOCK

- Universal coupling lock that fits most standard 50mm couplings
- Lock fits into coupling blocking access and prevents tow-away theft
- Expand in coupling by allen key, then lock
- High quality construction
- Corrosion proof
- Supplied with 2 keys

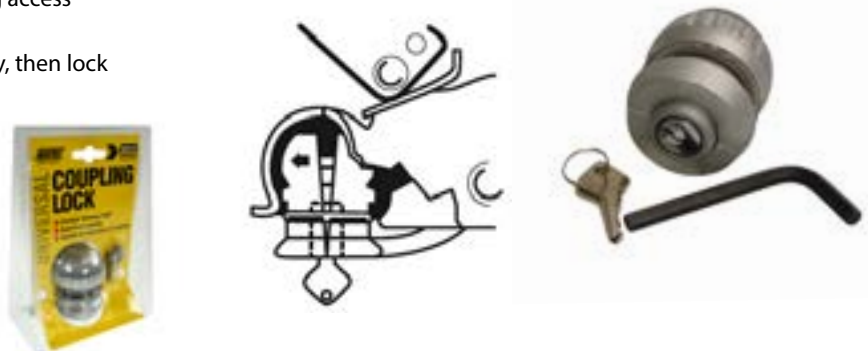

Code (Each)	Weight	Box Qty
MP279	0.45Kg	24

DELUXE TRAILER AND CARAVAN COUPLING LOCK

- Visible coupling lock prevents theft
- Lock fits into coupling blocking access and prevents tow-away theft
- Adaptable for standard 50mm pressed steel couplings on most types of trailer
- High security brass cylinder lock
- Easy press lock fitting



Code (Each)	Weight	Box Qty
MP9952	1.3Kg	24

HEAVY DUTY TRAILER HITCH COUPLING SAFE

- Steel coupling safe trailer hitch lock
- Complete with hardened steel close shackle padlock and 2 keys
- Fits most pressed steel couplings
- Full colour box



Code (Each)	Weight	Box Qty
MP89	2.7Kg	6

HEAVY DUTY REMOVABLE SECURITY POST

- Highly visible deterrent
- Steel construction
- Designed for concreting into the ground
- Effectively blocks driveways, carports and garages
- Removable to allow vehicle access
- Complete with hinged cover for when not in use
- Stainless steel padlock provided with 2 keys

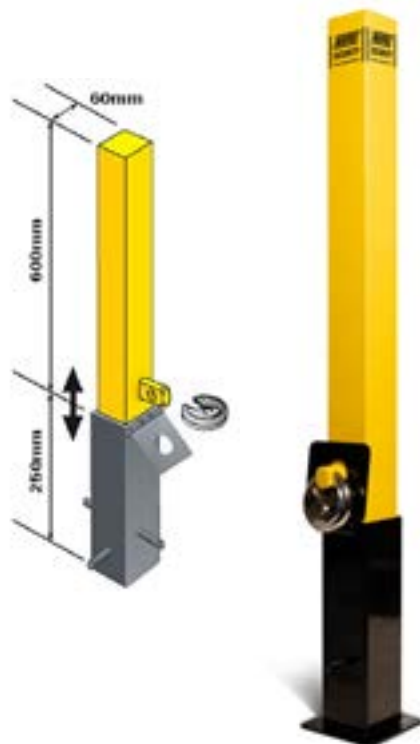

Code (Each)	Weight	Box Qty
MP9731	6.76Kg	3

HEAVY DUTY REMOVABLE TRAILER HITCH SECURITY POST

- Highly visible deterrent
- Steel construction
- Designed for concreting into the ground
- 50mm ball allows you to lock your trailer or caravan to the post
- Prevents theft of caravans and trailers fitted with a 50mm tow hitch
- Removable top section to allow vehicle access
- Ideal for private and commercial use
- Stainless steel padlock provided with 2 keys

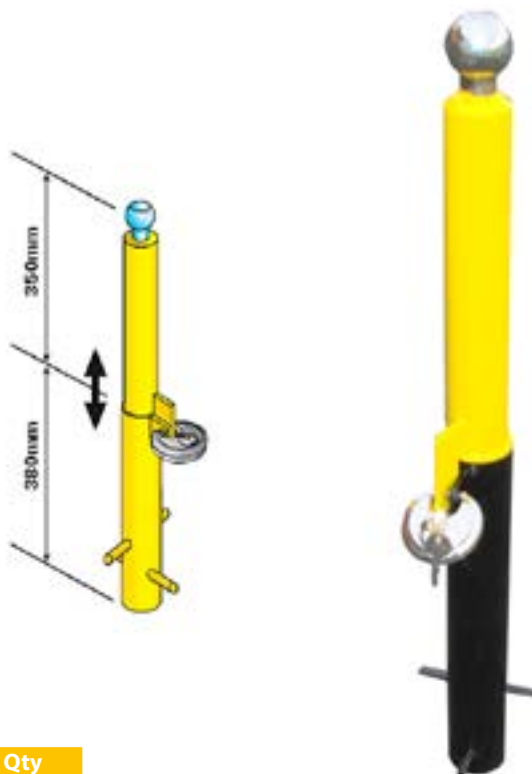

Code (Each)	Weight	Box Qty
MP9735	4.9Kg	3

HEAVY DUTY FOLD DOWN SECURITY POST (SET IN CONCRETE TYPE)

- Highly visible deterrent
- Steel construction
- Solid cast base
- Designed for concreting into the ground to restrict driveway access
- Effectively blocks driveways, carports and garages
- Folds down to allow vehicle access
- Designed for car, trailer, motorhome and caravan security
- Stainless steel padlock provided with 2 keys

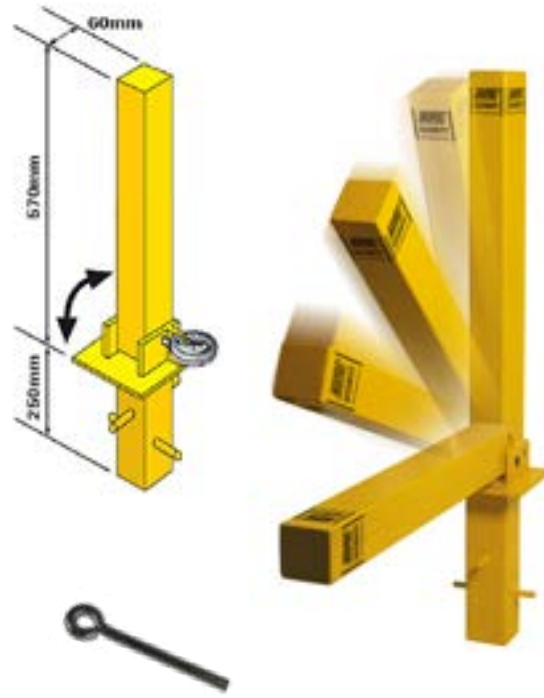

MP97371 - Spare eye pin

Code (Each)	Weight	Box Qty
MP9739	6Kg	3

HEAVY DUTY FOLD DOWN SECURITY POST (BOLT DOWN TYPE)

- Highly visible deterrent
- Steel construction
- Solid cast base
- Provided with high security fixing bolts to prevent being released once fitted
- Effectively blocks driveways, carports and garages
- Folds flat to ground for access
- Designed for car, trailer, motorhome and caravan security
- Ideal for private and commercial use
- Stainless steel padlock provided with 2 keys



MP97371 - Spare eye pin

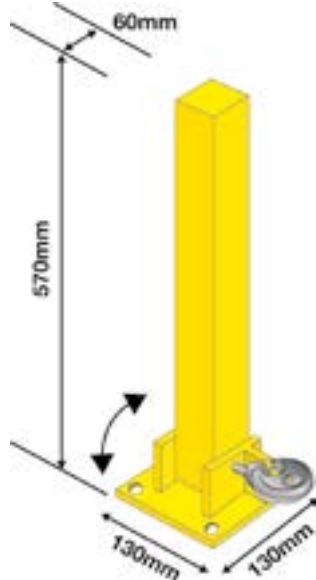

Code (Each)	Weight	Box Qty
MP9737	5Kg	4

ROUND FOLD DOWN SECURITY POST

- Additional security for private or commercial use
- Multi purpose use - suitable for driveways, garages, car parks, forecourts, parking spaces and much more
- Highly visible deterrent
- Folds down for convenient vehicle access
- Strong and robust steel
- 3 mounting holes for bolting into concrete (bolts not supplied)
- Includes integral lock and protective cover
- Height 620mm and diameter 60mm
- Fitting instructions included



Code (Each)	Weight	Box Qty
MP9733	2.65Kg	4

SQUARE FOLD DOWN SECURITY POST WITH INTEGRAL TOP LOCK

- Additional security for private or commercial use
- Bright yellow for high visibility
- 4 mounting holes for bolting into concrete - bolts not supplied
- Multi purpose use suitable for driveways, garages, car parks, forecourts and parking spaces
- Folds down for convenient vehicle access
- Top mounted integral lock with protective dust cap
- Height 600mm and 60x60mm section



Code (Each)	Weight	Box Qty
MP9732	3.17Kg	4

CORNER STEADY LEG LOCK

- Suitable for all corner steadies fitted with an exposed 19mm hexagonal drive
- Locks corner steady in down position to immobilise the caravan
- High security locking system
- Robust steel construction
- Water and corrosion proof
- Supplied with 3mm allen key and hexagonal driver
- Electro-plated for rust protection
- Patented design
- Insurance Approved and independently tested
- Quick and easy to fit
- Fit more than one for extra protection



Code (Each)	Box Qty
MP5491	10

UNIVERSAL WHEEL CLAMP

- A highly visible deterrent that is simple to use and can be fitted in seconds
- Robust steel construction for maximum protection
- Soft PVC coating prevents wheel damage
- Suitable for steel and alloy wheels
- Insurance approved
- Simple to use and fitted in second
- Compact design for easy use and storage
- Integral lock for extra security
- Supplied with 2 keys



Code (Each)	Tyre Width	Recommended For	Box Qty
MP9075	175-225mm	Cars, vans, motorhomes, caravans & trailers	4

MAYPOLE WHEEL CLAMPS

- A highly visible deterrent that is simple to use and can be fitted in seconds (once initial size set)
- Can be used without removing the wheel trim
- Fitted with a rubber pad to prevent wheel damage
- Two security plate settings for different tyre widths
- Security plate prevents access to wheel nuts
- Suitable for steel and alloy wheels
- Insurance approved
- Fully adjustable and folds for easy storage
- Supplied with 2 keys



Code (Each)	Typical Wheel Sizes	Tyre Width	Diameter Capacity	Recommended For	Box Qty
MP9061	8-10"	120-140mm	350-550mm	Caravans & trailers	4
MP9065	13-17"	175-215mm	450-650mm	Cars, caravans, vans & trailers	4

MAYPOLE HEAVY DUTY WHEEL CLAMP

- A highly visible deterrent that is simple to use and can be fitted in seconds (once initial size set)
- Can be used without removing the wheel trim
- Fitted with a rubber pad to prevent wheel damage
- Two security plate settings for different tyre widths
- Security plate prevents access to wheel nuts
- Suitable for steel and alloy wheels
- Insurance approved
- Fully adjustable and folds for easy storage
- Supplied with a corrosion proof, pick resistant lock with 3 keys



Code (Each)	Typical Wheel Sizes	Tyre Width	Diameter Capacity	Recommended For	Box Qty
MP909	10-16"	135-215mm	400-700mm	Cars, vans, caravans, trailers & motorhomes	4

TRIANGULAR HEAVY DUTY WHEEL CLAMPS

- Versatile heavy duty triangulation wheel clamp
- Fully adjustable (set once only) for wheel diameter and width
- Suitable for steel and alloy wheels
- Patented design
- Insurance Approved
- Electro plated arms for corrosion protection
- Strong and robust hardened steel construction
- High security pick-free lock, dust, water and corrosion proof
- Protective non scratch rubber plate pad, stops wheel damage
- Available in three sizes, each suited for different vehicles:
 - SH5433 - Trailers
 - SH5434 - Trailers, caravans, cars, vans and horse boxes
 - SH5435 - Trailers, caravans, cars, vans, horse boxes and motorhomes



KIT CONTENTS:

- Wheel clamp top plate
- Wheel clamp bottom plate
- Top arm
- Bottom arm
- Adjuster arms
- Lock with three keys
- 6mm allen key
- 2 x M10 x 12mm long socket screws
- 8 x M10 x 16mm long socket screws
- Fitting instructions and warranty card



Code (Each)	Description	Tyre Size	Tyre Width	Box Qty
MP5433	8" - 10" wheel clamp	Min: 383mm - Max: 550mm	Min: 100mm - Max: 175mm	2
MP5434	10" - 14" wheel clamp	Min: 450mm - Max: 690mm	Min: 155mm - Max: 205mm	2
MP5435	14" - 16" wheel clamp	Min: 650mm - Max: 850mm	Min: 185mm - Max: 250mm	2

INTEGRAL LOCK AND KEY SET

- Lock and key suitable for many pressed steel couplings including MP80/MP81
- Prevents the coupling handle from being operated
- Hitch not included
- Two keys provided



Display Pack	Bulk Pack
MP478	MP478B

INTEGRAL COUPLING LOCK FOR BRADLEY AUTOHEAD & AUTOJAW

- Suitable for Bradley Coupling Heads and Auto Jaws including MP2030 and D201
- High security integral lock, 4 keys, key ring and key documentation
- Thousands of different key combinations
- Supplied with 2 years warranty
- Hitch not included

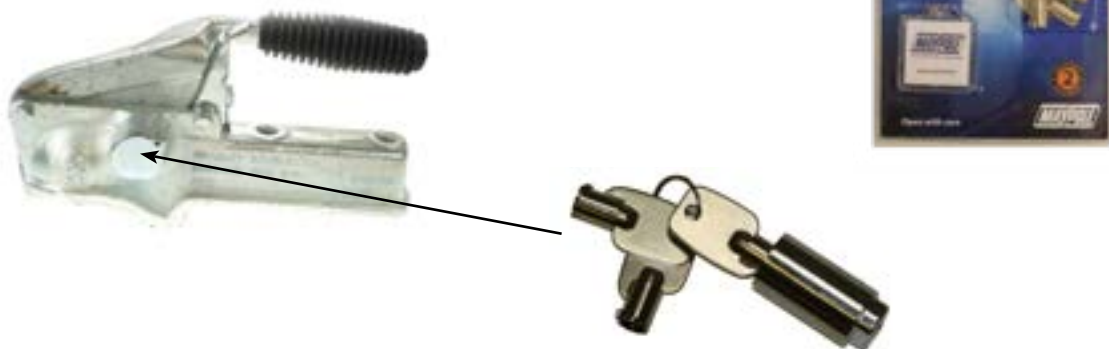

Code (Each)
MP201L

BARREL LOCK & KEY SET FOR KNOTT AVONRIDE COUPLING HEADS

- Replacement Coupling Barrel lock & key set for Knott-Avonride coupling heads up to 3500Kg
- Lock cover cap, two keys, lock housing pin and fitting instructions supplied
- Thousand of different key combinations
- Supplied with 2 years warranty
- Hitch not included



Code (Each)
MP2015L



Caravan Servicing

Did you know we also have a range of caravan servicing lines available?

We also stock a range of caravan servicing parts compatible with major brands and OE from leading manufacturer ALKO. This includes:

Coupling Dampers & Bellows

Quality German manufactured Stabilus branded products



Brake: shoes, cables, hub nuts & adjusters

Fully approved Maypole branded



Jockey Wheels

Including MP9757 which is specifically designed for caravans



Brake Service Lines

Brake shoe adjuster kits, expanders & cover plates



Lighting, Electrics & Reflectors



Electrics

Plugs, sockets and conversion adaptors



Request copies of our Trailer Servicing, Parts and Accessories and Trailer Lighting and Towing catalogues to find out more information!

Leisure Accessories

Caravan steps, parking and levelling and Grayston Spring Assisters.



Caravan Steps

LARGE PLASTIC STEP

- UV stable polypropylene plastic step
- Large tread area for maximum safety
- Tread size 445mm x 270mm
- Grey colour
- Manufactured according to EN14183:2003 standards
- Anti-slip tread
- Strong and stable construction
- Large feet with peg holes for extra stability when used on grass
- Maximum load 150Kg



Code (Each)	Weight	Step Height	Box Qty
MP5388	1.4Kg	235mm	10

SINGLE CARAVAN STEP - STEEL

- Robust steel construction
- Silver/grey painted
- Manufactured according to EN14183:2003 standards
- Anti-slip tread
- Maximum load 150Kg



Code (Each)	Weight	Step Height	Box Qty
MP538	2.2Kg	260mm	10

DOUBLE CARAVAN STEP - STEEL

- Reinforced steel construction
- Silver/grey painted
- Manufactured according to EN14183:2003 standards
- Anti-slip tread
- Maximum load 150Kg
- Only available in box or pallet quantities



Code (Each)	Weight	Step Height	Box Qty
MP5385	4.8Kg	200mm & 390mm	5
MP5385B	4.8Kg	200mm & 390mm	64

Caravan Steps

FLAT PACK DOUBLE CARAVAN STEP - STEEL

- Ideal for caravan, motorhome or around the home
- Robust steel construction
- Silver/grey painted
- Manufactured according to EN14183:2003 standards
- Rubber non-slip tread plates
- Step height 190mm and 380mm
- Anti-slip tread
- Easy push fit assembly, no tools required
- Maximum load 150Kg
- Only available in box
- Disassembles for storage
- Full colour box

Caravan & Motorhome Flat Pack Step



Code (Each)	Weight	Step Height	Box Qty
MP5387	5.26Kg	190mm & 380mm	4

DOUBLE CARAVAN STEP WITH HANDRAIL - STEEL

- Ideal for caravan, motorhome or around the home
- Reinforced steel construction
- Silver/grey painted
- Soft hand grip
- Universal handrail (left or right) fitment option
- Handle requires assembly to step, fittings included
- 2 reflectors to aid visibility at night
- Manufactured according to EN14183:2003 standards
- Rubber non-slip tread plates
- Anti-slip tread
- Easy to assemble
- Maximum load 150Kg
- Only available in box quantity



Code (Each)	Weight	Step Height	Box Qty
MP5386	6Kg	200mm & 390mm	4

Parking and Levelling

WHEEL CHOCK

- Essential accessory for cars, caravans and trailers
- A vital safety device when parking or changing a wheel
- Best used in pairs for chocking two wheels on a gradient or both sides of one wheel on the flat
- Can be purchased in a display box of 10 when buying in bulk



Display Pack (Single)	Bulk Pack (Each)	Box Qty
MP461	MP461B	10

TYRE GRIP TRACTION MAT

- Essential for escaping muddy fields
- Two mats easily join together
- Very durable, use again and again
- Highly visible
- Supplied as a pair



Code (Each)	Box Qty
MP536	10

CARAVAN JACK PAD SET

- Universal fit for all caravan legs / corner steadies
- Helps stabilise caravan on soft ground
- Strong, durable and easy to fit
- Permanent attachment to help save time
- Weighted design for when caravan is being towed
- Manufactured in the U.K.
- Supplied in a set of 4



Code (Set of 4)	Box Qty
MP4976	12

CARAVAN SPIRIT LEVEL

- Spirit level guide for easy caravan levelling
- With two fixing holes
- Size 60mm x 45mm

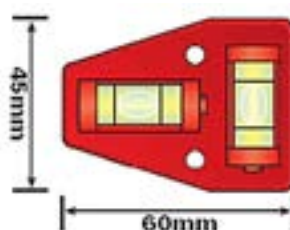

Display Pack	Bulk Pack
MP835	MP835B

Parking, Levelling and Grayston Spring Assisters

NOSE WEIGHT GAUGE

- Check weight before departure for safe and legal towing
- Ideal for caravans or trailers
- Calibrated easy to read scale
- 50-100Kg
- Accuracy within 3%
- Soft tip to prevent damage to hitch
- Helps stop overloading and load distribution
- Robust steel construction



Code (Each)	Box Qty
MP970	10

SPRING ASSISTERS AND RAISERS



- Coil Spring Assisters & raisers give your car an uprated spring rate, providing the following benefits when towing or carrying heavy loads:
 - Reduces light steering
 - Prevents suspension sag
 - Helps to prevent the vehicle from bottoming out
 - Helps to prevent headlights from aiming too high
- Ideal to use when towing caravans, trailers & motorbikes
- They are designed to be used as a temporary measure and are therefore quick and easy to fit
- Can be fitted without any special tools
- Manufactured from a hard rubber compound



Spring Gap Dim.	Code
To suit 18mm - 25mm	GE13
To suit 26mm - 38mm	GE14
To suit 39mm - 51mm	GE15
To suit 51mm - 65mm	GE15A

To work out which size you need, the spring gap needs to be measured when the car is jacked up, with the wheel off the ground. Then take the measurement of the gap between the coils where the assister will be fitted (usually in the middle of the spring) Please note: Spring assisters should only be fitted to the rear of a vehicle.

SEAT BELT CLIP



- Relieves seat belt tension
- Suitable for all inertia reel safety belts
- Allows movement without readjusting
- Supplied in a pack of 2



Code
GE16

FROLI ROUND WHEEL LEVELLER

- Innovative round wheel leveller from Froli
- An easier way to level a caravan or motorhome when in site or in storage
- Also acts as a tyre protector as it is perfectly matched to the wheel shape
- Tested load capacity 1250Kg per wheel
- Maximum gross weight 3850Kg
- Need approx. 28cm clearance from the vehicle to the ground
- Maximum lifting height approx. 10cm
- Approved for wheels approx. 70cm diameter
- No access aid required
- Patented design
- Pack includes one round wheel leveller

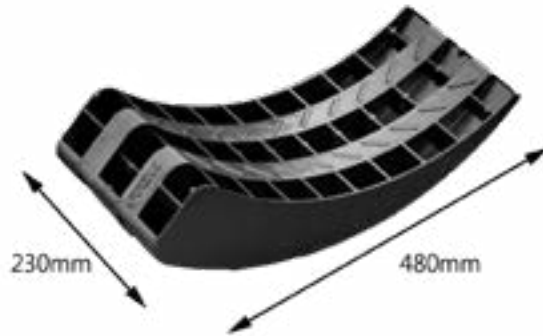

Scan the QR code to see the fitting video



Code (Each)	Width	Length	Tested Load Capacity
MP4606	230mm	480mm	1250Kg per wheel

FROLI TWIN LEVEL RAMP SET

- Set includes 2 wheel ramps
- Tested load capacity 2000Kg per wheel
- Perfect for caravans and motorhomes up to 8000Kg total weight
- Maximum levelling height 80mm
- The curved rear end of the ramp allows the leveller to be inserted between 2 wheels of some twin axle caravans
- The wheel leveller must rest entirely on solid ground



Code (Each)	Width	Length	Tested Load Capacity
MP4601	160mm	450mm	2000Kg per wheel

FROLI 3 PART LEVEL RAMP SET

- Set includes 1 level ramp, 1 easy access lead-in plate and 1 wheel chock
- Suitable for use with single and twin axles
- Tested load capacity 2000Kg per wheel
- Perfect for caravans and motorhomes up to 8000Kg total weight
- Maximum levelling height 80mm
- The curved rear end of the ramp allows the leveller to be inserted between 2 wheels of some twin axle caravans
- The wheel leveller must rest entirely on solid ground



Code (Each)	Width	Length	Tested Load Capacity
MP4603	160mm	450mm	2000Kg per wheel

FROLI 4 PART LEVEL RAMP SET

- Set includes 2 part level ramp, easy access lead-in plate and wheel chock
- Tested load capacity 2000Kg per wheel
- Parts can be used separately or together for levelling heights of 40, 55 and 95mm
- Combined height 95mm
- Product weight 1840g
- The wheel leveller must rest entirely on solid ground



Code (Each)	Width	Length	Tested Load Capacity
MP4605	180mm	500mm	2000Kg per wheel

FROLI TWIN MULTI-LEVEL RAMP SET

- Set includes 2 multi-level ramps and 1 heavy duty storage bag
- Suitable for use with single and twin axles
- Tested load capacity 1250Kg per wheel
- Perfect for caravans and motorhomes up to 5000Kg total weight
- 3 stepped levelling heights of 40, 70 and 100mm
- Product weight 1350g
- The ramp's wide non-slip surface increases stability on uneven, hard and soft ground
- The wheel leveller must rest entirely on solid ground



Code (Each)	Width	Length	Tested Load Capacity
MP4607	235mm	590mm	1250Kg per wheel

Mirrors

SINGLE EXTENSION TOWING MIRROR

- An additional rear view mirror that extends your field of vision
- Convex glass for a wider field of vision
- Fits most vehicles
- Easy to use
- Universal strap fixings
- European Approval



Code (Each)	Box Qty
MP8322	40

CONVEX TOWING MIRRORS (PAIR)

- An additional rear view mirror that extends your field of vision
- Convex glass for a wider field of vision
- Aerodynamic shape
- Strong fixings and chrome bar minimise vibration for a clearer view
- Robust and durable
- Additional safety strap
- Supplied as a pair
- Quick and easy clamp fittings are more versatile so are suitable for a wide range of vehicle shapes and sizes



Code (Each)	Box Qty
MP8329	10

Mirrors

LARGE DUAL GLASS TOWING MIRROR

- An additional rear view mirror that extends your field of vision
- Robust and durable construction
- Fits most large vehicle mirrors
- Recommended for 4x4s and MPV's
- Small convex and large flat glass dual mirrors
- Use in either orientation
- European Approval



Code (Each)	Box Qty
MP8324	20

DELUXE/DUAL GLASS AERO SHAPED TOWING MIRROR

- An additional rear view mirror that extends your field of vision
- Universal fit
- Robust and durable construction
- Modern aerodynamic shape
- Convex and flat glass
- Fits most large, deep and curved vehicle mirrors
- European Approval



Code (Each)	Box Qty
MP8326	20

DELUXE TOWING MIRROR

- An additional rear view mirror that extends your field of vision
- Easily adjustable clamps
- Robust and durable construction
- Universal fit
- Modern aerodynamic shape
- Available in flat or convex glass options
- Use in either orientation
- European Approval



Code (Each)	Glass Type	Box Qty
MP8327	Convex	20
MP8328	Flat	20

DRIVEWAY MIRROR

- Gives visibility for awkward driveway pull outs and blind spots
- Convex shatterproof mirror for a wider field of vision
- Lightweight plastic
- 300mm diameter
- Weather resistant
- Pole mounting
- All fixings and instructions included
- Display packed



Code (Each)	Box Qty
MP8325	12

Caravan and Camping Electrics

MOBILE MAINS ROLLER POWER UNIT

- 5 in 1 power supply for all your modern appliances
- Compact free standing roller ideal for storage and transportation - no messy cable to unravel
- 3 BS 13A sockets
- 2 x 5v/2.1A USB sockets for modern day devices
- Built in high quality RCD and circuit breaker for optimum protection against electric shocks
- Integral carry handle
- Built in LED light
- 230V 10A AC Max
- 15m orange PVC insulated cable with 100% copper conductors
- Manufactured to European Electrical Safety standards
- IP44 rated
- Full colour box



Code (Each)	Box Qty
MP3767	4

MOBILE MAINS POWER UNIT WITH USB

- 5 in 1 power supply
- Plugs directly into camp site power supply to bring safe 230V power to your appliances
- Ideal for use in your caravan, tent, awning, trailer tent, camper van or motorhome
- 3 BS 13A sockets pin power sockets, socket orientation perfect for large plugs and adaptors
- 2 USB sockets (1A and 2.1A) for modern day devices
- Built in RCD and circuit breaker for optimum protection against electric shocks
- Indicator light shows power supply is connected
- 16 amp total maximum capacity
- Integrated carry handle and tent pole/awning clips
- 15m orange PVC insulated cable with 100% copper conductors
- Socket Approval - BS1363
- Plug Approval - EN60309
- USB Approval - EN55022
- IP44 - Splash proof
- Full colour box



Code (Each)	Box Qty
MP3766	4

MOBILE MAINS POWER UNIT

- Plugs directly into campsite power supply to bring safe 230V power to your appliances
- Ideal for use in your caravan, tent, awning, trailer tent, camper van or motorhome
- Built in high quality RCD and circuit breaker for optimum protection against electric shocks
- 3 UK pin power sockets, socket orientation perfect for large plugs and adaptors
- Indicator light shows power supply is connected
- 10 amp maximum total capacity
- Handy carry handle tent pole clips
- 15m orange PVC insulated cable with 100% copper conductors
- Socket Approval - BS1363
- Plug Approval - EN60309
- IP44 rated
- Full colour box



Code (Each)	Box Qty
MP3765	4

230V SITE EXTENSION LEAD

- Caravan site extension lead
- 100% (3 core 2.5mm²) copper cable
- 16 amp/230V site connectors
- NCC (National Caravan Council) compliant
- Supplied with splash-proof 3 pin plug and socket
- Socket & plug Approval - EN60309
- IP44 rated
- Full colour box



Code (Each)	Cable Length	Box Qty
MP377	25m	4
MP3771	10m	8

230V EXTENSION LEAD (NOT NCC APPROVED)

- Extension lead cable
- 100% (3 core 1.5mm²) copper cable
- H05VV-F 3G1.5 PVC cable
- 230V 16 amp connection
- Not NCC Approved
- Socket & plug Approval - EN60309
- IP44 rated
- Display packed



Code (Each)	Cable Length	Box Qty
MP3773	10m	8
MP3772	25m	4

Caravan and Camping Electrics

230V 3WAY HOOK-UP SPLITTER

- 3-way hook-up splitter with 16 amp adaptor
- Ideal for caravan and camping sites when using multiple electrical accessories
- Plug Approval - EN60309
- IP44 rated



Display Pack	Bulk Pack	Box Qty
MP370	MP370B	20

230V 2WAY HOOK-UP SPLITTER

- 2-way hook-up splitter with 16 amp adaptor
- Ideal for caravan and camping sites when using multiple electrical accessories
- Plug Approval - EN60309
- IP44 rated



Display Pack	Bulk Pack	Box Qty
MP369	MP369B	20

230V 16 AMP EURO HOOK-UP LEAD

- Enables your caravan to be connected to mains power via European 2 pin socket
- 33cm 3 core orange 230V mains cable
- Supplied with a splash-proof 3 pin socket
- Socket Approval - DIN 0620-1
- Plug Approval - EN60309
- VDE 3G1.5mm² cable
- IP44 rated



Display Pack	Bulk Pack	Box Qty
MP371	MP371B	50

230V 16 AMP SITE PLUG

- Can be used as a spare plug or to make up a site extension lead
- Used in power supply leads for caravans and motorhomes (MP377 & MP3771)
- Plug Approval - EN60309
- IP44 rated



Display Pack	Bulk Pack	Box Qty
MP372	MP372B	100

230V 16 AMP SITE CONNECTOR

- Allows you to connect the mains inlet socket of your caravan or trailer
- Suitable for use as a replacement for an existing site electrics hook-up socket
- Supplied with a 230V splash-proof 3 pin socket
- Used in power supply leads for caravans and motorhomes (MP377 & MP3771)
- Socket Approval - EN60309
- IP44 rated



Display Pack	Bulk Pack	Box Qty
MP373	MP373B	100

230V 16 AMP UK HOOK-UP LEAD

- Enables your caravan to be connected to mains power via a domestic 3 pin socket
- Fitted with a 3 pin UK plug
- 26cm 3 core orange 230V mains cable
- Splash-proof connector
- Socket Approval - BS60309
- Plug Approval - EN1363
- IP20 rated



Display Pack	Bulk Pack	Box Qty
MP374	MP374B	50

230V 16 AMP UK TRAILING SOCKET

- Converts caravan site electrics for 3 pin British socket applications
- Socket Approval - BS1363
- Plug Approval - EN60309
- VDE 3G1.5mm² cable
- IP20 rated



Display Pack	Bulk Pack	Box Qty
MP375	MP375B	50

CARAVAN 230V UK TWIN TRAILING SOCKET

- 16 amp plug to 2 x 13 amp BS sockets
- Ideal for caravans, motorhomes and generators
- 41cm length cable
- Socket Approval - BS1363
- Plug Approval - EN60309
- IP20 rated



Display Pack	Bulk Pack	Box Qty
MP3752	MP3752B	20

16 AMP CARAVAN INLET WITH CAP

- 230V inlet
- Supplied with weather cap making this ideal for caravans and motorhomes when travelling
- Plug Approval - EN603609
- IP44 rated



Display Pack	Bulk Pack	Box Qty
MP594	MP594B	40

16A 240V 3PIN SOCKET SURFACE MOUNTED GARAGE OUTLET

- 16A 240V 3 Pin socket surface mounted garage outlet ideal for charging leisure batteries in camper vans, motorhomes and caravans
- 3 entry points to fit electrics
- IK Rating IK08
- ICE309 EU standard
- IP44 rated



Bulk Pack	Box Qty
MP5940B	40

CARAVAN 230V 16 AMP PLUG TO BS SOCKET ADAPTOR

- 16 amp plug to 13 amp socket adaptor
- Ideal for caravans, motorhomes and generators
- Socket Approval - BS1363
- Plug Approval - EN60309
- IP44 rated



Display Pack	Bulk Pack	Box Qty
MP3758	MP3758B	50

Caravan and Camping Electrics

240V 16 AMP MAINS FLUSH FIT INLET

- Replacement flush - mounting mains inlet socket for connecting a caravan, camper van or motorhome to site mains supply
- Rounded base allows for quicker fitment using a hole cutter
- Fitted with a hinged lid and locking peg
- Accepts caravan site mains lead or blue female site socket
- Splash-proof with an IP44 rating
- CE Approved
- Made from durable UV stable plastic
- Standard fit on a whole range of motorhomes and caravans
- Complete with black foam seal
- Includes lever to release female socket



Code (Each)	Colour	Box Qty
MP598B	White	25
MP5985B	Black	25

SINGLE POLE CUT OFF SWITCH

- 12/24V
- 100 amp max load
- Removable key for safety and security
- Suitable for use with towing and touring auxiliary batteries



	Display Pack	Bulk Pack
Switch	MP604	MP604B
Spare key	-	MP604KB

MARINE SINGLE POLE CUT OFF SWITCH

- 12/24V
- 100 amp max load
- Removable key for safety and security
- Protective rubber cap for marine use



	Display Pack	Bulk Pack
Switch	MP605	MP605B
Spare key	-	MP605KB

LEG WINDING SOCKET

- Extended socket for caravan leg winding
- 19mm socket
- Suits 10mm drill chucks
- Made from a strong and durable steel
- Only available in box quantities



Code (Each)	Length	Box Qty
MP76312	(12") 300mm	10
MP76320	(20") 500mm	10

CARAVAN LEG WINDING SOCKET

- 19mm socket
- 71cm long
- Specifically designed to use in difficult positions & places
- Features a free rotating knob on one end and a plastic rotating sleeve in the middle for ease of use
- Only available in box quantities



Code (Each)	Box Qty
MP760	12

Power Inverters

150W/300W/500W POWER INVERTERS WITH USB

Portable power when you need it most!

- Converts 12V DC to 230 AC
- **Equipped with essential protective safety features** - reverse polarity protection, over and under voltage protection, low battery shut down protection, low battery shut down protection and short circuit, overload and over temperature protection
- **Output wave form** - Modified sine wave
- Manufactured to European Electrical Safety standards
- High speed cooling fan



MP56050

Robust Aluminium Case

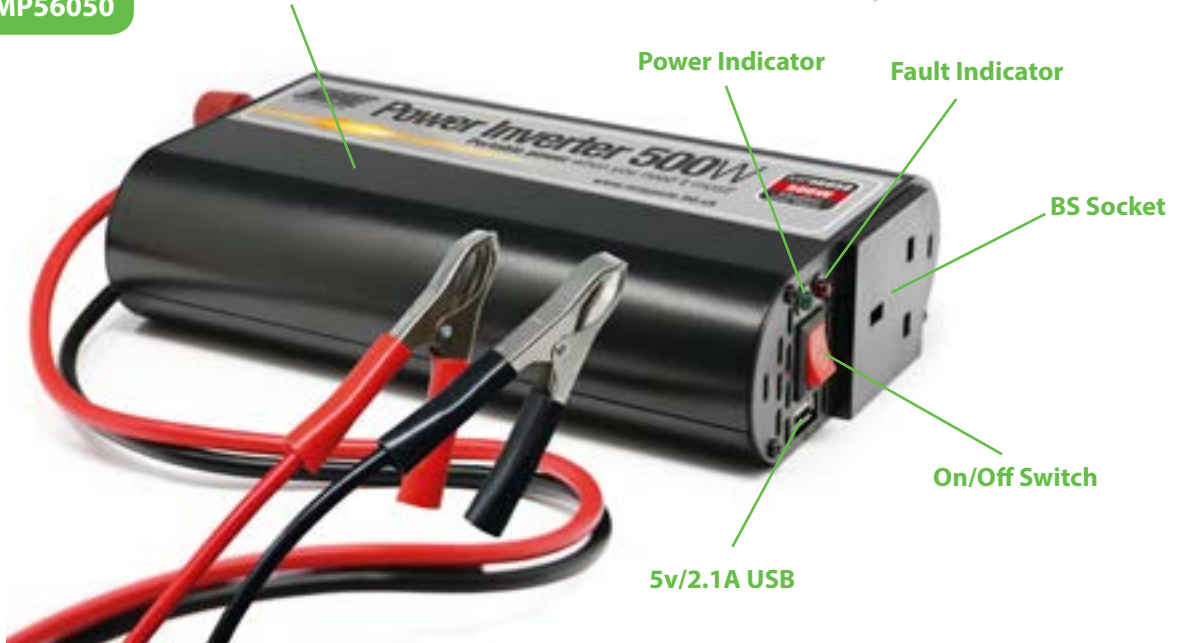

Technical Specification

Code	Constant Output	Peak Output	Input Voltage	Output Frequency	Output Voltage	USB Output Voltage	Other Applications	Box Qty
MP56015	150W	300W	12V DC	50-60Hz	220-240V AC	5V 1A		6
MP56030	300W	600W	12V DC	50-60Hz	220-240V AC	5V 2.1A		6
MP56050	500W	1000W	12V DC	50-60Hz	220-240V AC	5V 2.1A		6

MP56015 has a cigar lighter connection

Power Inverters

800W/1000W/1500W POWER INVERTERS WITH USB

Portable power when you need it most!

- Converts 12V DC to 230 AC
- Equipped with essential protective safety features - reverse polarity protection, over and under voltage protection, low battery shut down protection, low battery shut down protection and short circuit, overload and over temperature protection
- Output wave form - Modified sine wave
- Manufactured to European Electrical Safety standards
- High speed cooling fans with protective guard

MP56150

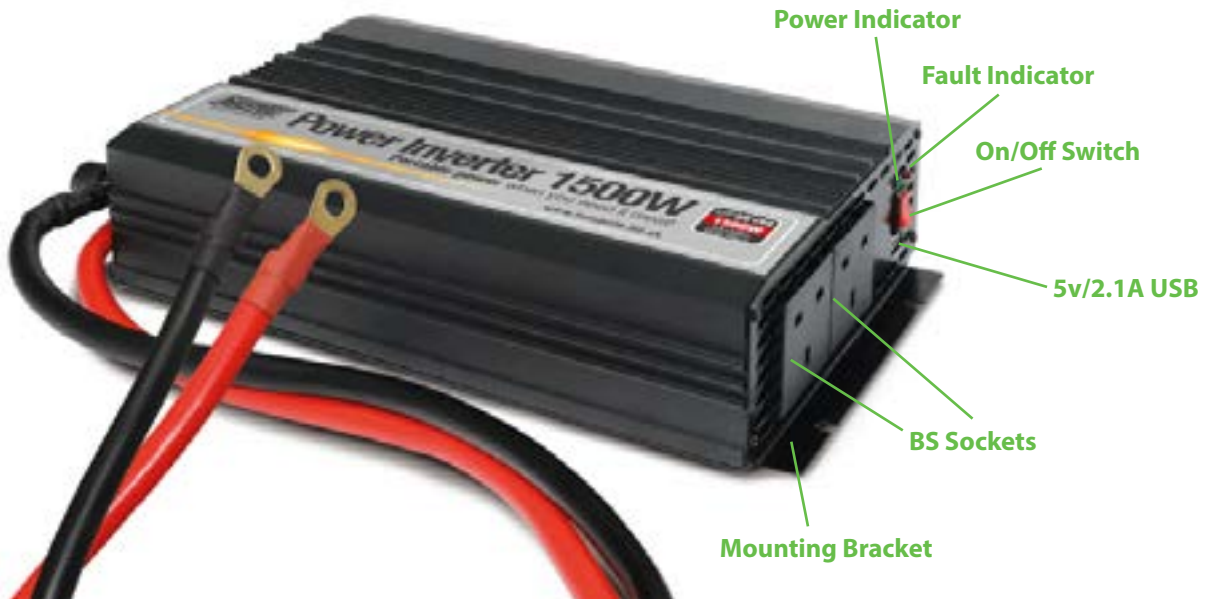

Technical Specification

Code	Constant Output	Peak Output	Input Voltage	Output Frequency	Output Voltage	USB Output Voltage	Other Applications	Box Qty
MP56080	800W	1600W	12V DC	50-60Hz	220-240V AC	5V 2.1A		6
MP56100	1000W	2000W	12V DC	50-60Hz	220-240V AC	5V 2.1A		2
MP56150	1500W	3000W	12V DC	50-60Hz	220-240V AC	5V 2.1A		2

Leisure Covers

Caravan, motorhome, camper van, and horse box covers. Motorhome and camper van internal and external blinds.



Caravan Covers

Maypole are the market leaders in the supply of universal covers to the leisure industry. It is essential to protect a caravan, motorhome or camper van exterior over the winter months from the outdoor elements, when on-site or in storage to protect against; dirt, dust, birds, leaves, mould and algae.

Maypole have over 20 years experience of manufacturing and supplying covers within the leisure industry. We now offer a comprehensive range designed to meet all requirements for today's modern vehicles. Designed for: Caravans, Motorhomes, Camper Vans to Horse Boxes.

Over the years Maypole have proven product quality and developed additional features across all ranges to ensure we continue to offer covers which customers can rely on.



Look out for the "4-ply features" logo on each of our cover pages in this section of the catalogue to find out which of our covers have the below features.

Key features across the 4-ply cover ranges include;



Breathable heavy duty non woven polypropylene 4-ply material, helping moisture to evaporate reducing the risk of mould, mildew or algae. Material also features a soft non-abrasive backing which is designed not to scratch a vehicle when fitted. Material is also bonded, using an innovative rounded pattern, helping it to resist stress and tears under normal conditions.



Material has high UV protection, ensuring a long product life.



Highly water resistant material (up to 1000mm hydrostatic pressure head test) providing excellent protection from the elements.



All covers are easy to fit with full fitting & care instructions provided.

Technical Information - 4-Ply material

Specification	
Layers	4
Composition	SB+SB+FILM+SB
Weight	163gm/m ²
Water repellency	80-90mm
Water resistance	1000mm
Rain test	<0.1

SB = Spunbound polypropylene

Film = Better water resistance than a membrane

For exact product dimensions please scan the QR code.



Protects against;



Smog & Dust



Rain & Wind



Frost & Snow



UV Rays



Leaves



Birds

"Water resistant" means the material will repel water but is not thoroughly waterproof. Maypole 4ply covers are independently tested and will withstand the pressure of up to 1000mm of water. The breathable material allows condensation and water to evaporate - essential for long term storage.

PREMIUM GREEN CARAVAN COVERS



Maypole's green caravan covers have additional features that are designed to improve the fit and functionality of the cover, including;

- 3 zip locations on the nearside for easy access to the door and to assist when fitting the cover. Please refer to drawing
- Adjustable straps on the rear and side of the cover to tighten the material when fitted. This ensures a safe fit in all conditions
- Reflectors on the front, side and rear enhances night time visibility
- Modern retail friendly display box with key features highlighted
- Breathable hitch cover with adjustable strap is included
- Supplied with storage bag

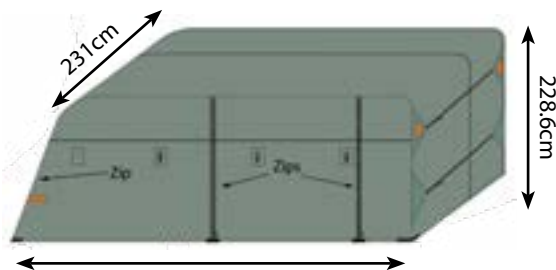

Measure along the bottom of the caravan excluding the A frame to find out your required size



Code	Size (Approx)		Width (cm)	No. of Side Straps
	Metric	Imperial		
MP9531	Up to 4.1m	14'	231	4
MP9532	4.1 - 5.0m	14'-17'	231	4
MP9533	5.0 - 5.6m	17' - 19'	231	5
MP9534	5.6 - 6.2m	19' - 21'	231	5
MP9535	6.2 - 6.8m	21'-23'	231	6
MP9536	6.8 - 7.4m	23'-25'	231	7



Reflectors front, side & rear for added visibility. Rear adjustable straps for a secure tight fit.



Convenient side zip providing easy door access.



Breathable hitch cover with adjustable straps.



Elasticated hem around the whole base of the cover allows a tailored fit.



3 strong heavy duty zips for easy fitment and access.



Extra strong double stitched adjustable side nylon straps.

Caravan Top Covers

WATERPROOF CARAVAN TOP COVERS

- Superior top cover offering protection for your caravan roof
- Protects against; UV rays, rain & wind, smog & dust, snow & ice, birds and leaves
- Designed to keep birdlime and tree sap from the roof of the caravan
- Waterproof heavy duty silver polyester material
- UV Stable material ensuring long product life
- Adjustable straps with nylon coated heavy duty steel hooks
- Non-abrasive padded protectors cover each adjustable buckle to prevent scratching or damage
- Manufactured from polyester with PU silver coating
- Hydrostatic pressure tested to 1500mm (for water resistance)
- Universal quick and easy to fitment
- Not suitable for use in exposed windy areas
- Handy storage bag for when not in use
- Fitting and care instructions provided
- Cover width 229cm, cover height 41cm



Code	Size (Approx)		Box Qty
	Metric	Imperial	
MP9261	Up to 4.1m	14'	4
MP9262	4.1 - 5.0m	14'-17'	4
MP9263	5.0 - 5.6m	17' - 19'	4
MP9264	5.6 - 6.2m	19' - 21'	4
MP9265	6.2 - 6.8m	21'-23'	4
MP9266	6.8 - 7.4m	23'-25'	4



Plastic coated heavy duty steel hooks.



Non-abrasive padded protectors cover each adjustable buckle to prevent scratching or damage.



Adjustable straps to tighten the cover when fitted.

Hitch Covers

HITCH COVER - BREATHABLE GREEN

- Breathable material to match our caravan cover material prevents moisture build-up
- Protects against; UV rays, rain & wind, smog & dust and snow & ice
- Universal and easy to fit
- Adjustable straps and buckles
- Height 75cm, width 63cm

Code (Each)	Box Qty
MP9258	10



HITCH COVER - UNIVERSAL

- Universal and easy to fit with adjustable straps and plastic buckles
- Protects against; UV rays, rain & wind, smog & dust and snow & ice
- Robust construction, ideal for caravans and trailers
- Heavy duty
- Made from nylon
- Height 75cm, width 62cm

Code (Each)	Box Qty
MP9256	20



HITCH COVER - DELUXE HEAVY DUTY

- Manufactured from heavy duty reinforced PVC material
- Protects against; UV rays, rain & wind, smog & dust and snow & ice
- Ideal for caravans and trailers
- Universal and easy to fit with adjustable nylon straps and robust plastic buckles
- Height 66cm, width 80cm

Code (Each)	Box Qty
MP925	10



Motorhome Covers



MOTORHOME COVERS

- Elasticated hem allows a tailored fit over a range of motorhome sizes
- Nylon straps on the side, front and rear to secure the cover when fitted
- Extra strong double stitched seams on the straps to ensure product life
- 4 zips positioned on both sides of the cover at the front and back for easy access
- Handy storage bag for when not in use
- Only available in grey
- Cover width 235cm, cover height 270.5cm



Measure the length at the bottom of the motorhome



Code	Size (Approx)		Width (cm)	No. of Side Straps
	Metric	Imperial		
MP9421	Up to 5.7m	19'	235	6
MP9422	5.7 - 6.0m	19'-20'	235	6
MP9423	6.1 - 6.5m	20' - 21'	235	7
MP9424	6.5 - 7.0m	21' - 22'	235	7
MP9425	7.0 - 7.5m	22'-25'	235	8
MP9426	7.5 - 8.0m	25'-27'	235	8



Heavy duty, durable zips to allow easy fitting and opening.



Elasticated hem and velcro fastenings.



Nylon straps on the sides, front and rear to secure the cover firmly in place.

Motorhome Blinds

EXTERNAL THERMAL MOTORHOME BLIND

- Keeps motorhomes cool in the summer and warm in the winter
- Universal fit for van based motorhomes (e.g. Peugeot Boxer, Fiat Ducato, Ford Transit etc.)
- Protects against; UV rays, rain & wind and snow & ice
- Tested from -20°C to +50°C
- Secured to the outside of the motorhome using the doors
- Complete with strong nylon adjustable straps for secure fitment
- Completely covers windscreen and side windows for privacy and protection
- Quilted insulated cover
- Zipped front panel
- Retail friendly packaging, which acts as a storage bag when not in use
- 4700 W x 900mm H



Code (Each)	Box Qty
MP6607	4



Zipped front panel to provide light in the motorhome when fitted.



Heavy duty, durable straps to allow easy fitting.



Retail friendly packaging that acts like a storage bag to keep the panels together when not in use.

Motorhome Blinds

UNIVERSAL INTERNAL THERMAL MOTORHOME BLIND

- Keeps motorhomes cool in the summer and warm in the winter
- Universal fit for van based motorhomes (e.g. Peugeot Boxer, Fiat Ducato, Ford Transit, Mercedes Sprinter etc.)
- Tested from -20°C to +50°C
- Optimum blackout for maximum privacy
- Quality 5 ply construction - Multi layer durable material with thermal foam and PVC thermal foil ensures maximum privacy, winter insulation and summer heat reflection
- 3 piece set - 1 front windscreen and 2 side window blinds
- High quality extra strong black suction cups for fitment to the window. Spare available see part number MP6611
- Silver reflective effect
- Retail friendly display bag with hook
- Supplied with a storage bag

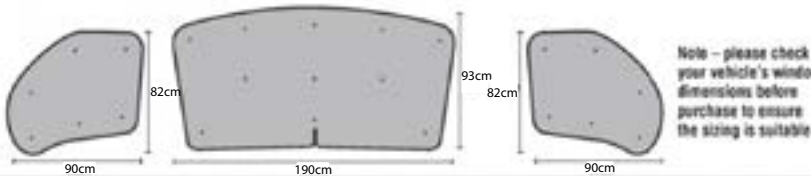

Code (Each)	Box Qty
MP6608	15

Camper Van Blinds

INTERNAL THERMAL BLIND SET FOR VOLKSWAGEN T4/T5/T6 CAMPER VANS

- Keeps vehicles cool in the summer and warm in the winter
- MP6609 is suitable for T4 Camper Vans
- MP6610 is suitable for T5 & T6 Camper Vans
- Tested from -20°C to +50°C
- Optimum blackout for maximum privacy
- Quality 5 ply construction - Multi layer durable material with thermal foam and PVC thermal foil ensures maximum privacy, winter insulation and summer heat reflection
- 3 piece set - 1 front windscreen and 2 side window blinds
- High quality extra strong black suction cups for fitment to the window. Spare available see part number MP6611
- Silver reflective effect
- Retail friendly display bag with hook
- Supplied with a storage bag



Code (Each)	Suitable for	Box Qty
MP6609	VW T4	15
MP6610	VW T5/T6	10

PACK OF REPLACEMENT SUCTION CAPS

10 high quality, extra strong replacement suction cups suitable for the following Maypole Internal Thermal Blinds:

- MP6608 Universal Motorhomes
- MP6609 Volkswagen T4
- MP6610 Volkswagen T5 & T6

Code (Each)	Box Qty
MP6611	10



Camper Van Blinds

EXTERNAL BLACKOUT SCREEN FOR VOLKSWAGEN T5/T6 CAMPER VANS

- Suitable for Volkswagen T5 and T6 Camper Vans
- Keeps vehicles cool in the summer and warm in the winter
- 100% blackout for maximum privacy
- Quality 4 layer thermal construction
- Strong velcro sides provide easy access to the passenger and driver's door
- Front screen drops down to let light in the vehicle without removing the whole screen
- Waterproof wipe clean material
- 3 piece set - 1 front windscreen and 2 side window screens
- Easy to fit



Corner fitment elasticated straps



Black out for privacy



Adjustable to allow light into the vehicle

Code (Each)	Box Qty
MP6612	4

Camper Van Covers

CAMPER VAN COVER GREY - VW T2



- Comes with elasticated hem for a tailored fit
- Protects against; UV rays, rain & wind, smog & dust, snow & ice, birds and leaves
- Breathable heavy duty non woven polypropylene 4-ply material, helping moisture to evaporate, reducing the risk of mould, mildew or algae
- Extra strong double stitched seam ensuring a long product life
- Suitable for all models of VW Type 2 camper van with:
 - Most roof options
 - Standard or lowered suspension
 - Rear cycle carrier or front mounted spare wheel
- 2 straps underneath the vehicle
- Handy storage bag for when not in use



Only suitable for Classic VW T2 Type



Code (Each)	Dimensions	No. of Side Straps
MP6582	L 4.5 x W 1.5 x H 1.6m	2



2 zip openings for driver & passenger doors make fitting easy.



3 straps at the back of the cover for a secure fit.



2 side nylon straps to secure the cover firmly in place.

Camper Van Covers

CAMPER VAN COVER GREY - VW T25/T3/T4/T5/T6



- Comes with elasticated hem for a tailored fit
- Protects against; UV rays, rain & wind, smog & dust, snow & ice, birds and leaves
- Breathable heavy duty non woven polypropylene 4-ply material, helping moisture to evaporate, reducing the risk of mould, mildew or algae
- Extra strong double stitched seam ensuring a long product life
- This cover will fit camper vans with a total overall length and height measurement of approx. 7.75m to 8.75m
- Also fits camper van with:
 - Standard or high top
 - Short or long wheel base
 - Rear cycle carrier or ladder
 - Side mounted awning blind
- 2 straps under the vehicle
- Handy storage bag for when not in use



Size Guide

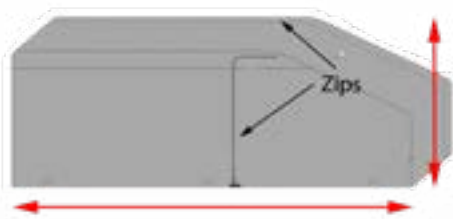

L + H = Approx Size



Code (Each)	Dimensions	No. of Side Straps
MP6584	L 5.0 x W 2.0 x H 1.7m	2



2 zip openings for driver & passenger doors make fitting easy.



3 straps at the back of the cover for a secure fit.



2 side nylon straps to secure the cover firmly in place.

CAMPER VAN COVER GREY - DUCATO/BOXER



- Comes with elasticated hem for a tailored fit
- Protects against; UV rays, rain & wind, smog & dust, snow & ice, birds and leaves
- Breathable heavy duty non woven polypropylene 4-ply material, helping moisture to evaporate, reducing the risk of mould, mildew or algae
- Extra strong double stitched seam ensuring a long product life
- This cover will fit camper vans with a total overall length and height measurement ranging from 7.75m to 8.75m
- Also fits camper van with:
 - Standard or high top
 - Short or long wheel base
 - Rear cycle carrier or ladder
 - Side mounted awning blind
- Fits Fiat Ducato, Ford Transit & Peugeot Boxer
- 2 straps underneath the vehicle
- Handy storage bag for when not in use

Size Guide

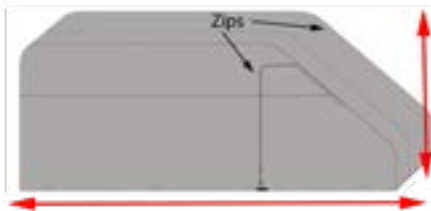

L + H = Approx Size



Code (Each)	Dimensions	No. of Side Straps
MP6586	L 6.3 x W 2.3 x H 2.6m	2



2 zip openings for driver & passenger doors make fitting easy.



3 straps at the back of the cover for a secure fit.



2 side nylon straps to secure the cover firmly in place.

Horse Box Cover



HORSE BOX COVER

- Fits 3.3m to 3.7m (including Ifor Williams HB-506 & HB-511)
- Extra strong double stitched seam ensuring a long product life
- Note - top doors cannot be latched open when cover is fitted
- Colour co-ordinated hitch cover included
- Handy storage bag for when not in use

Size Guide

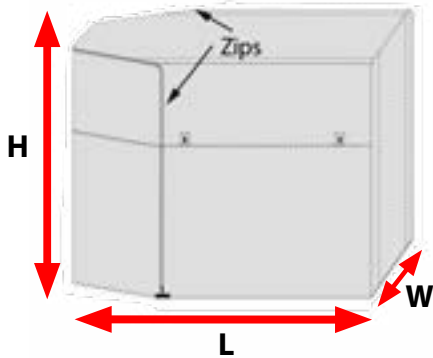

Code (Each)	Dimensions	No. of Side Straps
MP6595	L 3.7 x W 2.05 x H 2.5m	2



2 zip openings give access to the front loading ramp & groom's door.



Elasticated hem gives a tailored fit to a range of horse box sizes.



2 side nylon straps to secure the cover firmly in place.



Caravan & Motorhome Accessories

Air awnings, universal sun canopy, drive-away awning kits, caravan and awning accessories, storage bags, interior and awning lamps, cleaning and toilet fluid.

Air Awnings

SEASONAL
PRODUCT -
ORDER EARLY
TO GUARANTEE
STOCK

AIR DRIVE-AWAY AWNING

- Suitable for camper vans with a maximum height of 210cm
- All weather 150D Oxford Polyester Material
- UV Rating 30+
- 3000mm hydrostatic head water resistance
- Fully taped waterproof seams throughout
- 4 Access points - Full front door, right side door, left and right side cowl doors
- Interconnecting zip back rear cowl door for easy vehicle access
- 3 windows/mesh ventilation panels - front, right hand side and left hand side
- Sewn in ground sheet
- Front door fibreglass porch canopy
- Double action high volume pressure release pump
- Carry bag and pegs included
- H 210cm x L x 374cm x W 310cm



AIR DRIVE-AWAY AWNING

Don't forget
your awning
lamps on
page 138!

Additional features:



Large 134cm cowl tunnel



Highly visible storm straps included



Elasticated toggles to hold up doors/windows and mesh panels



Dual awning piping (4mm/6mm)



External valve covers



2 point inflation air frame

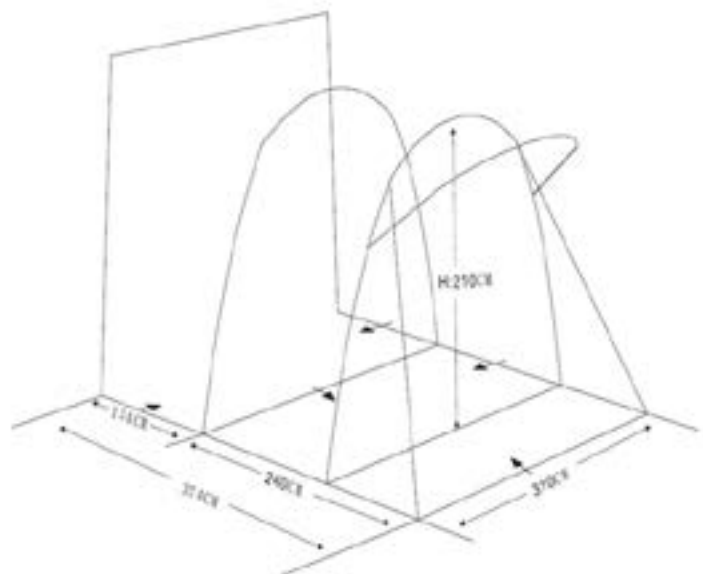
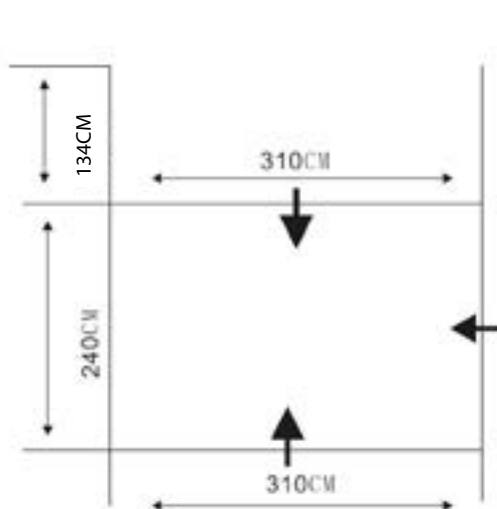

Code (Each)	Weight	Pack Size	Box Qty
MP9516	13.5Kg	H 39cm x L 82cm x W 39cm	1

Air Awnings

SEASONAL
PRODUCT -
ORDER EARLY
TO GUARANTEE
STOCK

2 BERTH INNER TENT FOR MP9516 AIR DRIVEAWAY AWNING

- 2 Berth clip in inner tent
- A quick and easy way to create sleeping space
- Compatible with the Air Driveway Awning (MP9516)
- 190T Breathable polyester material
- Sewn in waterproof PE groundsheet
- 2 fully zipped door panels
- H 190cm x L 122cm x W 270cm



Code (Each)	Weight	Box Qty
MP9521	1Kg	4

SEASONAL
PRODUCT -
ORDER EARLY
TO GUARANTEE
STOCK

POP UP SCREEN HOUSE (4)

- Quick and easy single person pitch
- All weather 210D Oxford polyester material
- UV Rating 30+
- Taped seams
- 1000mm hydrostatic head water resistance
- Sides roll down fully for privacy and for protection from the elements
- Includes mesh sides and fully zipped sidewalls and front door
- Carry bag included
- H 210cm x L 240cm x W 240cm



See next page for more information

Air Awnings

POP UP SCREEN HOUSE (4)

Additional features:

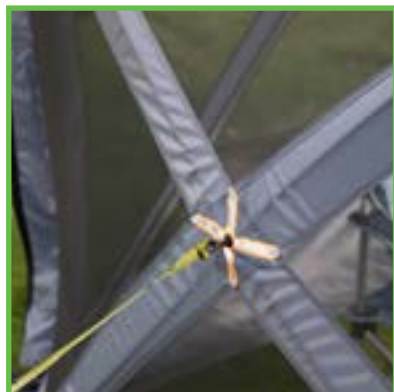

Strong anchor points on 3 sides



Mesh sides act as a barrier against insects



Elasticated toggles to hold up sidewalls



Storm straps and pegs included



Solid fibreglass poles



Handy storage pockets

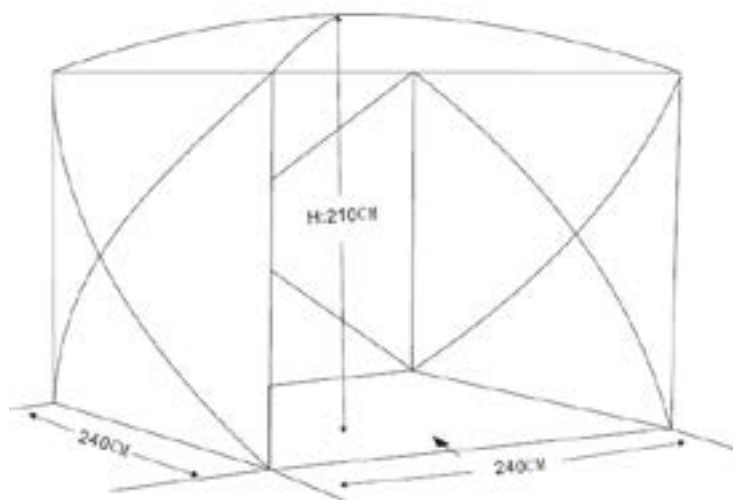
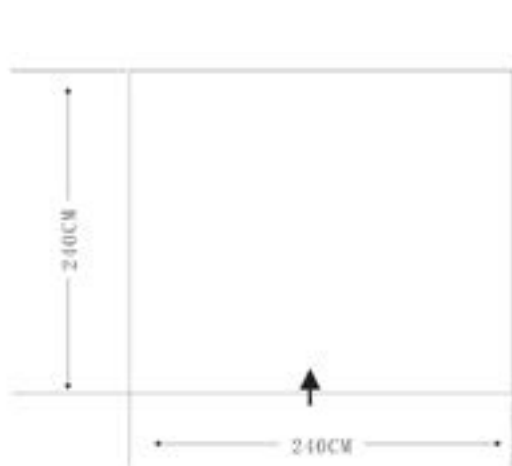

Code (Each)	Weight	Pack Size	Box Qty
MP9517	9.3Kg	H 21cm x L 175cm x W 21cm	1

**SEASONAL
PRODUCT -
ORDER EARLY
TO GUARANTEE
STOCK**

TIDY STORAGE TENT

- Weatherproof outdoor storage
- Ideal for outdoor leisure furniture, chairs, bikes, windbreaks or toys
- Durable 190T polyester material
- UV Rating 30+
- 3000mm hydrostatic head water resistance
- Fully taped waterproof seams throughout
- Sewn in ground sheet
- Carry bag, pegs and guy ropes included
- H 175cm x L 196cm x W 84cm



**Capacity to store 2
adult size bikes**



Fibreglass frame



**Extra pegging points
on every side**

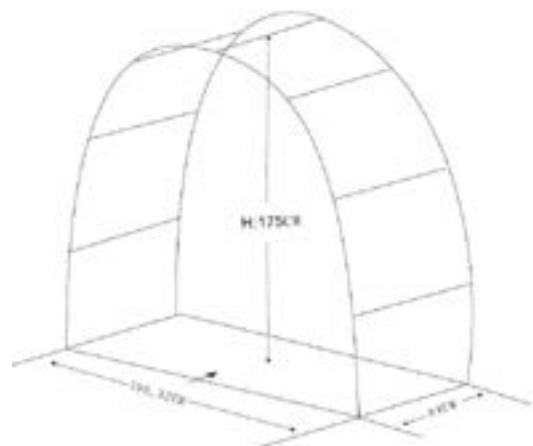
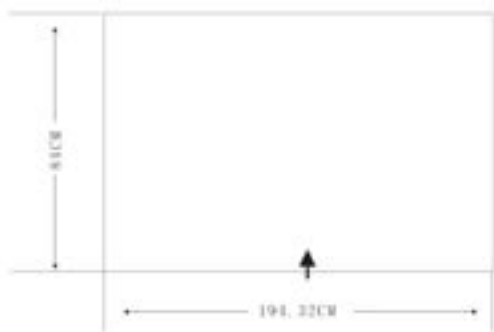

Code (Each)	Weight	Pack Size	Box Qty
MP9518	1.2Kg	H 10cm x L 56cm x W 14cm	6

Sun Canopy

UNIVERSAL SUN CANOPY

Will fit any vehicle with a 6mm or 4mm awning rail between a height of 1.6m to 2.5m

- Unique dome shape provides quick and easy extra space (W 2.5m, L 2.5m, Max H 2.5m)
- Highly water resistant (3000mm)
- Adjustable steel legs for uneven ground
- Grey colour
- Strong plastic feet prevent sinking into soft ground for maximum stability
- 5 guy ropes and with pegs for extra stability
- Suitable for camper vans, caravans, motorhomes and vans



Adjustable steel legs for uneven ground

Box Quantity	Code (Each)
4	MP9513



For 6mm or 4mm awning rail channel



5 guy ropes for extra stability. Highly visible to avoid trip hazard

Drive-Away Awning Fixing Kits

DRIVE-AWAY AWNING FIXING KITS

- Quick and easy attachment for your drive-away awnings
- Available in two sizes (6mm-6mm/6mm-4mm)
- Suitable for any vehicle with an awning channel
- Convenient attachment and detachment of drive-away awnings when on-site
- Water resistant to 1000mm
- Kador strip is 150D Oxford fabric with PVC coating
- UV stable
- Kit includes:
 - 1 x 3m kador strip
 - 3 x 1m figure of 8 PVC extrusions
 - 1 x handy storage bag



Code (Each)	Description	Box Qty
MP9510	6mm - 4mm	25
MP9511	6mm - 6mm	25

MAGNETIC DRIVE-AWAY AWNING FIXING KIT

- Quick and easy attachment for your drive-away awnings
- Universal fit - suitable for any type of vehicle
- Suitable for when your vehicle does not have an awning channel
- Includes 4 x adjustable straps for maximum security
- Kit includes:
 - 1 x 3m magnetic kador strip
 - 3 x 1m figure of 8 PVC extrusions
 - 1x handy storage bag



Code (Each)	Description	Box Qty
MP9512	Magnetic	15

Caravan and Awning Accessories

EPSOM AWNING CARPET

- Woven awning carpet is made of durable, breathable material that allows grass to breathe and prevents discolouration whilst the close weave acts as an effective barrier to insects and worms
- The carpet is rot proof, UV stable and features securing eyelets
- Grey colour and comes in a range of sizes
- Easily cleaned with a pressure washer or hose
- Ideal for awnings
- Supplied in a reusable storage bag
- Wide range of sizes available



Code (Each)	Size	Box Qty
MP93525	2.5m x 2.5m	10
MP93530	2.5m x 3m	10
MP93535	2.5m x 3.5m	10
MP93540	2.5m x 4m	7
MP93545	2.5m x 4.5m	5
MP93550	2.5m x 5m	5
MP93555	2.5m x 5.5m	5
MP93560	2.5m x 6m	5
MP93565	2.5m x 6.5m	5



HEAVY DUTY SCREW IN PEGS

- Thick heavy duty steel pegs with corkscrewed shaft for extra grip
- Includes a 13mm drill adaptor and storage box
- 13mm hexagonal head ensure pegs can be driven into hard or stoney ground using a drill
- Multi purpose use; ideal for camping and caravan sites to ensure a secure pitching
- Tough plastic head with a hooked design to aid pulling out of the ground
- Bright orange head for maximum visibility
- Supplied with storage case



HEAVY DUTY ROCK PEGS

- Heavy duty steel rock pegs with peg puller and storage box
- Sharp tips are designed for driving into the hardest of ground with a mallet or hammer
- Multi purpose use; ideal for camping and caravan sites to ensure a secure pitching
- Tough plastic head with a hooked design to aid pulling out of the ground
- Bright orange head for maximum visibility
- Supplied with storage case



Code (Each)	Description
MP9519	20 pegs with adaptor
MP9519B	100 pegs without adaptor

Code (Each)	Description
MP9520	20 pegs with peg puller
MP9520B	100 pegs without peg puller

12M CARAVAN AWNING RAIL PROTECTOR

- Keeps your awning rail clean and protects it against damage
- Helps to prevent black streaks caused by water run-off
- A dirt free awning rail allows easy fitment of your awning
- White PVC
- Easily cut to length
- Slots inside awning channel



Code (Each)	Length	Box Qty
MP951	12m	20

CARAVAN AND MOTORHOME DRAFT SKIRT

- Excellent for draft exclusion into awning especially when used with wheel covers (MP93665)
- Cut to length as required
- Fits directly into vehicle's awning channel
- Manufactured from reinforced grey PVC
- Protects against wind and rain
- Includes eyelets for security
- Ideal for use with awning



Code (Each)	Vehicle	Size
MP95150	Caravan	50cm x 50m roll
MP95175	Motorhome	75cm x 50m roll

WHEEL COVER AND PEGS

- Designed to protect tyres when parked to prevent the sun's harmful UV rays causing tyre degradation and splitting which can lead to tyre blow-outs
- 2 eyelets plus pegs for securing into soft ground
- Can be used in conjunction with "Caravan Skirt" for added draft exclusion (MP95150)



Code (Each)	Vehicle	Size	Box Qty
MP93665	Caravan wheel cover	63cm x 21cm	20

Caravan Accessory Storage Bags

Essential storage bags for your camping accessories



AQUAROLL/WATER HOG STORAGE BAG

- Nylon bag with pull cord closure and spring toggle
- For the Aquaroll or Waterhog
- Blue



Code (Each)	Box Qty
MP6621	20

AWNING AND TENT POLE STORAGE BAG

- Nylon bag with pull cord closure and spring toggle
- Universal fit
- Blue



Code (Each)	Box Qty
MP6624	20

WASTEMASTER/WASTE HOG STORAGE BAG

- Nylon bag with pull cord closure and spring toggle
- For the Wastemaster or Wastehog containers
- Blue



Code (Each)	Box Qty
MP6622	20

AWNING AND TENT CANVAS STORAGE BAG

- Nylon bag with pull cord closure and spring toggle
- Universal fit
- Blue



Code (Each)	Box Qty
MP6625	20

AWNING FLOOR TILE STORAGE BAG

- Zip bag with carrying handles ideal for awning floor tiles
- For foam tiles (up to 62x62cm) and edging strips
- Holds up to 16 x 12mm tiles or 13 x 15mm tiles
- Suitable for awning carpet
- Polyester



Code (Each)	Box Qty
MP6626	20

SITE LEAD STORAGE BAG

- For 10/25m extension leads
- Zip fastening
- Blue
- Carry handle
- Diameter 40cm



Code (Each)	Box Qty
MP37705	20

INSULATED WATER CARRIER STORAGE BAG

- Designed to reduce the risk of water freezing in the winter
- Cover can be reversed, helping to reflect sunlight and keep water cooler in the summer
- Suitable for water carriers up to 40L including Waterhog, Aqua Roll, Water Porter & Aquarius
- Padded polyester insulation
- Cover for water supply hose for added protection
- Easy to fit, wrap around design with Velcro fastening
- Highly water resistant material



Code (Each)	Box Qty
MP6623	4

PADDED 24" TV STORAGE BAG

- Ideal for storing and transporting flat screen TVs, in-car DVD players and game consoles
- Suitable for TV's up to 24"
- Rigid side and padded interior for screen protection
- Handy storage pocket for leads and accessories



Code (Each)	Box Qty
MP6635	10

Interior and Awning Lamps

10W AWNING/DOOR LAMP WITH HALOGEN BULB

- 12V, 10W
- Ideal for door illumination
- 140 lumens
- White
- IP66 rated
- Perfect for caravans and motorhomes



Code (Each)	Length	Width	Box Qty
MP82961	250mm	90mm	50

10W INTERIOR AWNING LAMP



- 12V, 10W
- On/off switch
- Britax 891
- With bulb included 1x245
- 100 lumens



Display	Bulk	Length	Width	Box Qty
MP35	MP35B	120mm	120mm	22

INTERIOR AWNING LAMP



- 12V, 20W
- On/off switch
- Britax 896
- Bulbs included
- 250 lumens
- Special order only



Code (Each)	Length	Width	Box Qty
MP877B	355mm	55mm	20

WRAP AROUND CARAVAN LAMP



- Caravan replacement lamp
- Bulbs included 3 x 382 1 x 380
- 12V
- E Approved
- Britax 9300



Code (Each)	Length	Width
MP379	382mm	130mm

FLEXI LIGHT 1.2M STARTER KIT

- 1.2m flexi light
- 36pc white LED's (720 Lumens)
- 12V DC 230V mains power supply
- On/off dimmer
- 3 strips can be linked together
- Carabiner clips and easy to use end connectors to link 3 lights together
- Ideal for tents and awnings
- Easy to fit velcro attachment compatible with air tubes and awning poles
- Waterproof case (IP68)
- Comes with storage bag

■ Starter Kit contents:

- 1.2m flexi light
- 230V UK mains adaptor with 5m cable
- 12V cigarette lighter adaptor with 5m cable
- Dimmer switch
- Storage bag

■ Extension kit contents:

- 1.2m flexi light



Code (Each)	Description	Box Qty
MP82962	Starter kit	5
MP82963	Add on kit	10

Cleaning and Toilet Fluids

SUPERIOR 2L BLUE TOILET FLUID

- Eco friendly toilet fluid for caravans, motorhomes and boats
- A formaldehyde free high quality fragrant toilet fluid
- Breaks down waste effectively
- Leaves a fresh smell in the bathroom
- Works with Maypole toilet rinse
- Manufactured in the UK
- 2 litre bottles



Code (Each)	Box Quantity	Pallet Quantity
MP6991	8	320

SUPERIOR 2L PINK TOILET RINSE

- Superior fragrant toilet rinse for caravans, motorhomes, boats and portable toilets
- Disinfects toilet with each rinse leaving it clean and free of bacteria
- Leaves a fresh smell in the bathroom
- Works with Maypole toilet fluid
- Manufactured in the UK
- 2 litre bottles



Code (Each)	Box Quantity	Pallet Quantity
MP6993	8	320

TWIN 2L PACK SUPERIOR TOILET RINSE & FLUID

- Twin pack contains 2 litre toilet rinse and toilet fluid (MP6991/MP6993)
- For caravans, motorhomes and boats
- Cellophane wrapped
- Ideal as a promotional line



Code (Each)	Box Quantity	Pallet Quantity
MP6997	4	160

Cycle Carriers

Rear mounted cycle carriers and accessories.



Cycle Carriers

TOWBALL MOUNTED 4 BIKE CYCLE CARRIER

- Carries up to 4 bikes (total 60Kg)
- Sliding adjustable cradles that suit racing bike to mountain bike tyres
- Rapid lock quick release handle allows you to easily fit the carrier to the towball - no tools required
- Lockable arms are provided to secure each bike to the support bar
- Tilting system - allowing quick access to the boot
- Compatible with European 50mm Towballs
- Modern UK specified lights
- Extra lashing straps supplied for extra security when in use
- Supplied with a 13pin – 7 pin adaptor
- Foldable for storage
- TUV approved



Code (Each)	Weight	Box Qty
BC3024	17Kg	1

REAR MOUNTED 3 BIKE CYCLE CARRIER WITH EASY-FIT CRADLES & STRAPS

- Carries up to 3 bikes (total 45Kg)
- Strong aluminium alloy frame
- Features easy fit cradles and straps to secure the bike to the carrier
- 6 fixing straps give security and stability when in use
- "Clam-shells" allows various arm positions to suit a wide range of vehicles
- "Quick-lock" lever on clam shells
- Foam pads protect vehicle body work from damage
- Fully factory-assembled and ready to use
- Folds for easy storage
- Fits most: saloons, hatchbacks, vans, estates and coupés



Code (Each)	Box Qty
BC2085	4
Code (Each)	Spares
BC20851	Cradle for the BC2085
BC20852	Strap for the BC2085

REAR MOUNTED 2 BIKE CYCLE CARRIER

- Carries up to 2 bikes (total 30Kg)
- 6 fixing straps give security and stability when in use
- Soft foam covered arms
- "Clam-shells" allows various arm positions to suit a wide range of vehicles
- Extra-large foam pads protect vehicle body work from damage
- Fully factory-assembled and ready to use
- Folds for easy storage
- Fits most: saloons, hatchbacks, vans, estates and coupés



Code (Each)	Box Qty
BC2060	2
Code (Each)	Spares
BC2001	Glass fixing kit

Accessories & Foldable Roof Box

BIKE FRAME ADAPTOR

- For bikes without cross-bar (e.g. ladies bikes/suspension bikes)
- Allows secure stable attachment to most rear mounted cycle carriers
- Push button gate openings prevent accidental detachment
- PVC coated gates prevent damage to bikes
- 16"-28" / 410-710mm gate opening range
- Adjustable length
- Robust steel construction
- Maximum load 15Kg



Code (Each)	Box Qty
BC2089	20

CYCLE CARRIER LIGHTING BOARD

It is a legal requirement to use a cycle carrier lighting board if the rear lights and number plate are obstructed. Please visit our website or request a copy of our Trailer Lighting Catalogue for more information on our range of trailer lighting boards

- Standard Ex-stock

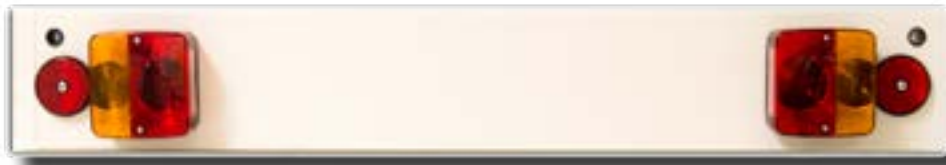

Code	Board Length	Cable Length	Lamps	Reflectors	Quantity
MP8551P	0.92m (approx. 3')	2m	MP17B x 2	MP854B x 2	10

320L ROOF BAG

- The easy to store alternative to a roof box
- Protects load with waterproof material, seams and sealed zip
- Fast and secure fitting with a solid base
- Universal fitment - Fits directly onto roof bars (min 66cm/ max 82cm roof bar spacing)
- Compact storage
- High tensile U bolts
- Adjustable straps
- Max capacity 50Kg
- Aerodynamic shape



Code (Each)	Box Qty
MP6639	4

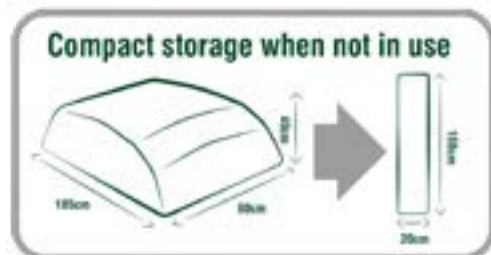

M-WAY

MENABO

Whether you are making a trip to your favourite holiday destination; taking the kids to cycle round the park, or exploring mountain terrain on your bike, **Menabo will get you there.**

Menabo is a range of quality cycle carriers and roof bars, manufactured by Italian company F.lli Menabo, which was founded in 1972.



M-Way is a quality brand of universal, vehicle specific roof bars, cycle carriers and roof boxes owned by Menabo.

Maypole is the exclusive distributors of Menabo and M-Way products in the UK and Ireland, delivering quality products for any budget, requirement or taste.

To find out which roof bar fits a specific vehicle, we have application lists for each bar available on our website. The website also features a registration look-up function; input your vehicle registration and it will take you to the bar that is right for that vehicle. Simple, easy and user friendly.

When you see this icon visit www.maypoleltd.com to view the application lists for all of the M-Way roof bars.



For Life's *Adventures*

CONTENTS

- Stylish modern designs
- Easy to fit and with minimal assembly required
- Manufactured to the highest quality standards
- Unique and useful features
- Range of accessories and replacement spares available

M-WAY ROOF BARS

The range includes roof bars for vehicles with integrated and raised roof rails, as well as vehicle specific roof bars with the appropriate fixing kit. When the need for more space is required on a commercial vehicle, we have a selection of roof bars to help carry the load.

UNIVERSAL ROOF BARS



VEHICLE SPECIFIC ROOF BARS



M-WAY CYCLE CARRIERS

Whatever the activity, we have a cycle carrier to help you do it. Whether you prefer a roof mounted carrier, or one to use on your towball, we have a range to suit any requirement or taste.

ROOF MOUNTED CYCLE CARRIERS



TOWBALL MOUNTED CYCLE CARRIERS



M-WAY ROOF BOXES

When extra storage is needed for the holiday journey, M-Way roof boxes provide the best solution. Supplied in three sizes, they are stylish, aerodynamic and very easy to fit to a range of roof bars.

ROOF BOXES



M-Way Avia Universal Aluminium Roof Bar Sets for “Integrated” & “Raised” Roof Rails



- Profiled and aerodynamic shape reduces noise
- To find out your vehicles load capacity, please look at the application lists on our website
- Use the vehicle registration look-up on our website to find out which bars are suitable
- Gap closures reduce wind noises
- Simple and fast assembly
- Retail box supplied with application list on the side
- Instructions included

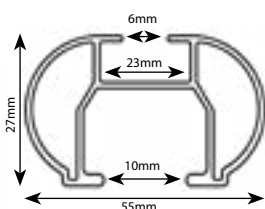

Part no.	Length	Weight	Safety Approved load	Lockable	Box Qty
RB1020	120cm	4.20Kg	75Kg	✓	4
RB1025	135cm	4.60Kg	75Kg	✓	4

M-Way Eagle Universal Aluminium Roof Bar Sets for "Raised" Roof Rails



- Suitable for raised roof rails
- Supplied with 13 x 13mm T-bolts which slide into the T-track slot on the top of the roof bar. This allows the full width of the bar to be used and accessories to be fitted securely
- Profiled and aerodynamic shape reduces noise
- To find out your vehicles load capacity, please look at the application lists on our website
- Use the vehicle registration look-up on our website to find out which bars are suitable
- Retail box supplied with application list on the side
- Instructions included
- RB250 - M-Way t-bolt kit

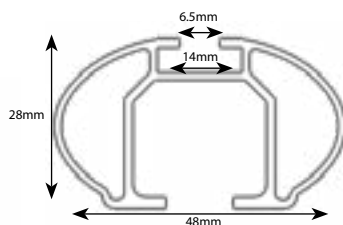

Part no.	Length	Weight	Safety Approved load	Lockable	Box Qty
RB1040	120cm	3.56Kg	75Kg	✓	6
RB1045	135cm	3.99Kg	90Kg	✓	6

M-Way Space Roof Bars



- Profiled and aerodynamic shape reduces noise
- Fits over 400 makes and models of vehicle on the road today and the application lists are updated regularly
- Also fits a range of small vans
- While the aluminium bar is lightweight, the steel bar is coated in black plastic for a durable finish
- Rotary end caps allows you to add T-bolts when the bars are fitted
- Foot kit included in the roof bars
- Customers must order fixing kits separately
- Retail box supplied with application list on the side
- Simple and fast assembly
- Instructions included

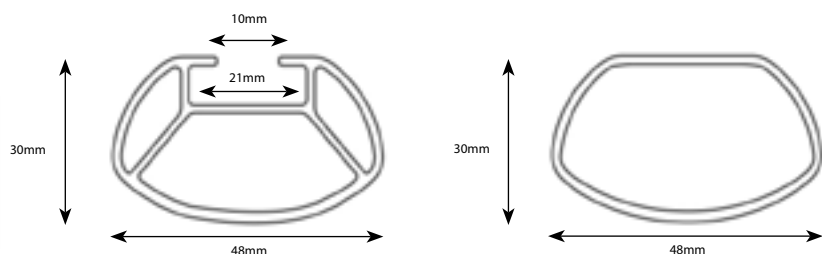

Part no.	Space Bar	Length	Weight	Safety Approved load	Construction	Lockable
RB2005	A	1.12m	4.90Kg	50Kg (door arch) & 75Kg (fixed point)	Steel	Optional
RB2020	A	1.12m	3.50Kg	50Kg (door arch) & 75Kg (fixed point)	Aluminium	Optional
RB2010	B	1.30m	5.70Kg	50Kg (door arch) & 75Kg (fixed point)	Steel	Optional
RB2025	B	1.30m	4.10Kg	50Kg (door arch) & 75Kg (fixed point)	Aluminium	Optional

M-Way Space Fixing Kits



So you have picked your roof bar, now you need to know what fixing kit you require. Depending on your vehicle, you will need one of the following styles of fixing kit;

STANDARD



FIXED POINT



For Life's *Adventures*

SPECIAL

Hybrid kit that includes different fixings for the front and back of the vehicle.



- Step 1** Visit www.maypole.ltd.uk/M-Way and enter your vehicle registration
- Step 2** Select the bar type and length
- Step 3** Discover which fixing kit you need
- Step 4** Keep a record of the part numbers and head to our stockist section

Vehicle Examples for Fixing Kits

We have tried to make the process of choosing the right bar and fixing kit as easy as possible. To illustrate we have a few examples of which bar and fixing kit is required for some of the most popular vehicles on the road.



Example of a vehicle that requires a STANDARD FIXING KIT

Ford Fiesta, 5 door, 2018 registration plate
Requires Space Bar A 1.12m, choose from aluminium or steel



Fixing Kit RB002

Example of a vehicle that requires a FIXED POINT KIT

Peugeot 4008, 5 door, 2018 registration plate
Requires Space Bar A 1.12m, choose from aluminium or steel



Fixing Kit RB016

Example of a van that requires a FIXED POINT KIT

Citroen Berlingo, 5 door, 2018 registration plate
Requires Space Bar B 1.30m, choose from aluminium or steel



Fixing Kit RB055

Example of a vehicle that requires a SPECIAL FIXING KIT

Vauxhall Corsa, 5 door, 2018 registration plate
Requires Space Bar A 1.12m, choose from aluminium or steel



Fixing Kit RB020

RB249 M-Way Optional Lock Kit for Space Bars

- Lock your roof bar to the vehicle to prevent theft



M-Way Raptor Single Cycle Carrier



- Mounts to vehicle roof bars with U-bolts supplied or optional T-bolt kit (page 117)
- Suitable for narrow tube bike frames only
- Can be used with various weight bearing roof bars with maximum dimensions of 58mm x 50mm
- Constructed from powder coated steel
- Nylon fixing straps provided to secure bike to carrier (1)
- Thumb wheel opens to 45mm
- Fixings and instructions included

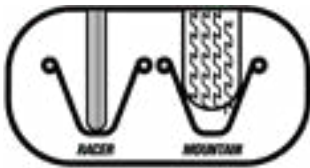

Part no.	Bikes	Weight	Safety Approved Load	Lockable
RB1050	1	2.65Kg	15Kg	Optional - RB1099

Menabo Merak Cycle Carriers



- Featuring Rapid-lock, an adjustable quick release handle which allows you to easily fit the carrier to the towball
- Sliding straps for a quick fixing to secure the wheels to the carrier (1)
- Arms are provided to secure each bike to the support bar (2). Each jaw arm is padded to protect the bike frame. Optional locks available
- Tilts to give you access to the boot of the car
- Modern chrome UK specified lights



2.



1.



Part no.	Bikes	Weight	Max Load Capacity	Pallet Qty	Lockable
BC3052	2	14kg	30kg	20	Optional - RB1099
BC3053	3 (extension)	2.85kg	45kg	20	Optional - RB1099

Menabo Shadow Cycle Carrier



- BC3055 is for VW T5 and BC3056 is for VW T6
- Sliding wheel support with ratchet straps for a quick fixing of the wheel to the carrier which suits any width tyre (racing bike tyres to mountain bike tyres) (1)
- Unique fixing system without straps. No drilling into the body work required.
- Lockable arms are provided to secure each bike to the support bar (2). Each jaw arm is padded to protect the bike frame
- Foldable for easy transport and storage
- Lockable anti theft knobs to secure the frame to the carrier (3)
- Suitable for Volkswagen T5 & T6's with a single rear door (Tailgate door)
- Not suitable for vehicles fitted with a spoiler
- Lightweight aluminium profiles



Part no.	Bikes	Weight	Safety Approved Load	Pallet Qty	Lockable
BC3055	3	15.4kg	45Kg	8	✓
BC3056	3	15.4kg	45Kg	8	✓

M-Way Nighthawk Cycle Carriers



- Featuring Rapid-lock, an adjustable quick release handle which allows you to easily fit the carrier to the towball (4)
- All arm locks on the carrier are keyed alike so only one key is required
- Sliding, adjustable cradles that suits any width tyre (racing bike tyres to mountain bike tyres) (2)
- An extra lashing strap is supplied for security when towing the carrier with bikes
- Lockable arms are provided to secure each bike to the support bar. Each jaw arm is padded to protect the bike frame (1)
- Tilts to give you access to the boot of the car
- Foldable for storage (3)
- Modern chrome UK specified lights
- Supplied with 13 Pin to 7 Pin adaptor



3.



4.

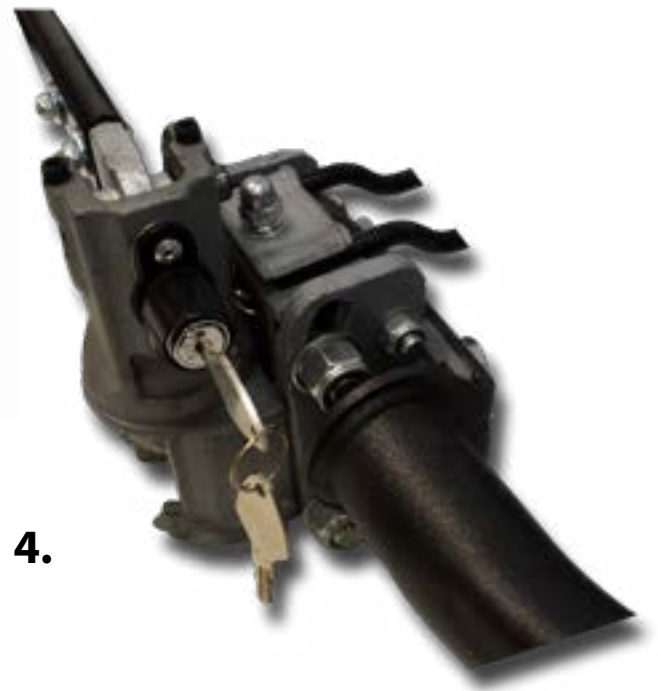

Part no.	Bikes	Weight	Safety Approved Load	Pallet Qty	Lockable
BC3022	2	17.6Kg	30Kg	8	✓
BC3023	3	20.4Kg	45Kg	8	✓

M-Way Typhoon 3 Cycle Carrier

- Featuring Rapid-lock, an adjustable quick release handle which allows you to easily fit the carrier to the towball in seconds
- Easy-fit cradle and straps
- Fits all 50mm flange and swan-neck towballs
- Simple and fast assembly
- Full visual instructions included
- No assembly required
- Safety clip
- Spares available



Part no.	Bikes	Weight	Safety Approved Load	Lockable	Box Qty
BC2035	3	4.97Kg	45Kg	✓	4

Venom Roof Boxes



- Stylish and sleek black finish
- Constructed from tough ABS material
- Multiple fixing holes along the bottom of the roof box are designed to suit any length of vehicle
- Central locking system with multi-point latch provides maximum security and safety
- Aerodynamic for reduced wind noise
- No tools required when fitting
- Easy to fit and secure
- Fits onto all M-Way roof bars and other brands
- Crash bar at the front of the roof box to protect the contents if involved in a collision (1)*
- Twin dynamic spring struts, stabilises lid when open (2)
- U-bolts are supplied to fit the box to the roof bar. Optional T-bolt kit is also available
- Supplied with lashing straps to secure the load inside
- Supplied fully assembled
- City crash tested



Part no.	Litre	Dimensions	Maximum Carry Capacity	Pallet Qty	Lockable
MW5320	320	138 L x 79 W x 37 H	50Kg	6	✓
MW5400	400	165 L x 79 W x 37H	50Kg	6	✓
MW5460	460	198 L x 79 W x 37H	50Kg	3	✓

*Please note there is no crash bar on the MW5320

Index

A

Air Fittings 59

B

Battery Chargers 4-16

Battery Cut Off Switches 108

Bike Frame Adaptor 144

Booster Cables 19-23

Breakdown Essentials 26

C

Camper Van Covers 121-123

Car Covers 46-49

Car Key Signal Blocker 81

Caravan Accessory Storage Bags 136-137

Caravan & Awning Accessories 134-135

 Epsom Awning Carpet 134

 Awning Rail Protector 135

 Awning Skirt 135

Caravan & Camping Electrics 104-108

Caravan Covers 113-115

Caravan Hitch Covers 115

Caravan Leg Winding Brace 108

Caravan Steps 95-96

Caravan Top Covers 114

Cargo Straps 45

Car Mats 55

Car Boot Liner 51

Cleaning & Toilet Fluids 140

Compressors 32-38

Contact Tips 56

Cycle Carrier Accessories 144

Cycle Carrier Lighting Boards 144

D

Digital Pressure Gauge 31

Display Stands 24

Disposable Gas Cylinders 57

Drive-away Awning Kits 133

F

Foot Pumps 30

Froli 99-100

G

Gas Cups 56

Gas Cylinder 57

Grayston Spring Assisters 98

Grease Gun 58

Grip Mats 97

H

Hi-Visibility Vest 26

Head Mask 57

Horns 43

Horse Box Cover 124

I

Inspection Lamps 49-42

Interior & Awning Lamps 138-139

J

Jack Pads 97

L

Luggage Straps 45

M

Maypole Cycle Carriers 142-143

Mig Wire 56

Mirrors 101-103

Mobile Mains Power Units 104-105

Motorhome Blinds 117-118

Motorhome Covers 116

MPV/4X4 Covers 48

M-Way 145-157

 Fixing Kits 150-151

 Roof Boxes 157

 Roof Mounted Cycle Carriers 152

 Towball Mounted Cycle Carriers 153-156

 Universal Roof Bars 147-148

 Vehicle Specific Roof Bars 149

N

Nose Weight Gauge 98

P

Parking & Levelling 97-98

Parking Sensor 28

Power Banks 17-18

Power Inverters	109-110
Power Packs	17-18
R	
Ratchet Straps	44-45
Recovery Towing Straps	44
Retail Stands	24
Reversing Camera	29
S	
Safety Wear	26
Seat Covers	52-53
Security – Maypole	78-92
Caravan Leg Lock	88
Coupling Lock	84
Hitchlocks	82-83
Integral Lock & Key Set	91-92
Locking Wheel Nuts & Bolts	77
Security Posts	85-87
Wheel Clamps	98-90
Security – Stronghold	62-77
Hitchlocks	64-69
Locking Wheel Bolts	77
Plastic Security Ball	77
Wheel Clamps	71-76
Scooter Cover	50
Spare Wheel Covers	50
Spray Guns	58
Start Chargers	15-16
Steering Wheel Locks	79-80
Sun Canopy	132
T	
Tow Poles	28
Tow Ropes	27
Towing Straps	27
Trolley Chargers	15-16
Tyre Pressure Gauge	31
Tyre Inflation Gun	31
Tyre Inflator With Tyre Chuck	31
Triangles	26

V	
Van Door Lock	81
Van Seat Covers	52-53
Vehicle Horns	43
W	
Warning Triangles	26
Welding Accessories	56-57
Contact Tips	56
Gas Cups	56
Gas Cylinders	57
Gloves	57
Masks	57
Mig Wire	56
Wheel Covers	135
Wheel Chocks	97
Wheel Wrenches	26
Windscreen Covers	50
Wiper Blades	54
Workshop Chargers	13-14

Terms and Conditions

1. INTERPRETATION

1.1 In these Conditions the following words shall have the following meanings:

"Buyer" means the purchaser of the Goods;

"Conditions" means the standard terms and conditions of sale set out in this document and (unless the context otherwise requires) includes any special terms and conditions agreed in writing between the Seller and the Buyer;

"Contract" means any contract incorporating these Conditions between the Seller and the Buyer for the sale and purchase of the Goods;

"Goods" means the goods agreed in the Contract to be supplied by the Seller to the Buyer; and

"Seller" means Maypole Limited a company registered in England and Wales under number 1502304 whose registered office is at 162 Clappgate Lane, Woodgate Business Park, Birmingham B32 3DE.

1.2 In these Conditions references to any statute or statutory provision shall unless the context otherwise requires, be construed as a reference to that statute or statutory provision as from time to time amended, consolidated, modified, extended, re-enacted or replaced.

1.3 In these Conditions headings will not affect the construction or interpretation of these Conditions.

2. APPLICATION OF TERMS

2.1 Subject to any variation under condition 2.3, these Conditions comprise all the terms of the Contract between the Seller and the Buyer to the exclusion of all other terms and conditions (including any terms or conditions which the Buyer purports to apply under any purchase order, confirmation of order, specification or other document). No statement, written or oral, including statements in any price list, brochure or promotional literature of the Seller shall be incorporated into the Contract or have any legal effect.

2.2 The terms in these Conditions shall prevail over any terms put forward by the Buyer and no conduct of the Seller shall constitute acceptance of any terms put forward by the Buyer unless the Seller expressly agrees to them in writing signed by a director of the Seller.

2.3 No additions to or variations of these terms shall be binding on the Seller unless in writing signed by a director of the Seller.

2.4 No employee or agent of the Seller has any authority to make any representations on behalf of the Seller as to the effect of these terms.

2.4 Maypole do not operate a sale or return policy, all stock cleanse and returns must be authorized by a Director and a 20% re-stocking charge will be deducted

2.5 Returns will only be accepted when a Maypole return note has been completed stating reasons for the return

2.6 Maypole reserve the right to close the account if, the minimum annual spend of £1000 has not been achieved.

2.7 Account will be setup once initial order, for the value of £250.00 has been met.

3. PRICE

3.1 Unless expressly agreed in writing by a director of the Seller or the Seller's sales staff the price for the Goods shall be the price set out in the Seller's price list published on the date of delivery or deemed delivery.

3.2 The Seller reserves the right to vary its published price list by written notice to the Buyer.

3.3 Unless expressly stated otherwise all prices are exclusive of value added tax.

4. PAYMENT TERMS

4.1 Payment for the Goods is due no later than 30 days end of month invoiced.

4.2 Time for payment shall be of the essence.

4.3 The Buyer shall make all payments due under the Contract without any deduction whether by set-off, counterclaim, discount, abatement or otherwise.

4.4 If the Buyer fails to pay the Seller any sum due pursuant to the Contract the Buyer;

4.4.1 will be liable to pay interest to the Seller on such sum from the due date for payment at the annual rate of 6% above the base lending rate from time to time of Lloyds Bank, accruing on a daily basis until payment is made. The Seller reserves the right to claim interest under the Late Payment of Commercial Debts (Interest) Act 1998; and

4.4.2 the Seller shall be entitled (without prejudice to its other claims and rights under the Contract) to suspend or cancel further deliveries or services under this Contract and any other contract between the Seller and the Buyer and treat the Contract as wholly repudiated by the Buyer and forthwith to terminate the Contract.

5. DELIVERY

5.1 The Seller shall use reasonable endeavors to meet any delivery date but any date named by the Seller for delivery is given and intended as an estimate only and is not to be the essence of the Contract. The Buyer shall nevertheless be bound to accept the Goods when delivered.

5.2 The Seller shall not be liable to the Buyer for any losses caused to the Buyer by the late delivery of the Goods.

6. FORCE MAJEURE

6.1 The Seller reserves the right to without liability defer the date of delivery or to cancel the Contract or reduce the volume of the Goods ordered by the Buyer (without liability to the Buyer) if it is prevented from or delayed in the carrying on of its business due to circumstances beyond the reasonable control of the Seller including, without limitation, acts of God, governmental actions, war or national emergency, acts of terrorism, protests, riot, civil commotion, fire, explosion, flood, epidemic, lock-outs, strikes or other labour disputes (whether or not relating to either party's workforce), or restraints or delays affecting carriers or inability or delay in obtaining supplies of adequate or suitable materials.

7. QUALITY

7.1 The Seller warrants that (subject to the other provisions of these Conditions) upon delivery the Goods will:

7.1.1 conform with any description given to the Buyer by the Seller; and

7.1.2 be of satisfactory quality within the meaning of the Sale of Goods Act 1994.

7.2 It is the Buyer's responsibility to inspect and test the Goods and each and every part thereof to see that they are in order.

7.3 If any of the Goods do not conform with any of the warranties in condition 7.1 the Seller shall at its sole option either:

7.3.1 repair or replace the defective Goods (or the defective part); or

7.3.2 allow full credit for the defective Goods provided that if the Seller so requests the Buyer shall at the Seller's expense return the Goods or the part of such Goods which is defective to the Seller.

8. LIMITATIONS ON LIABILITY

8.1 Subject to condition 7 the following provisions set out the entire financial liability of the Seller (including any liability for the acts or omissions of its employees, agents and sub-contractors) to the Buyer in respect of:

8.1.1 any breach of these Conditions; and

8.1.2 any representation, statement or tortious act or omission including negligence arising under or in connection with the Contract.

8.2 All warranties, conditions and other terms implied by statute or common law (save for the conditions implied by section 12 of the Sale of Goods Act 1979) are, to the fullest extent permitted by law, excluded from the Contract.

8.3 Nothing in these Conditions excludes or limits the liability of the Seller for death or

personal injury caused by the Seller's negligence or fraudulent misrepresentation.

8.4 Subject to conditions 8.2 and 8.3:

8.4.1 the Seller's total liability in contract, tort (including negligence or breach of statutory duty), misrepresentation, restitution or otherwise arising in connection with the performance or contemplated performance of the Contract shall be limited to the price paid by the Buyer to the Seller for the Goods.

8.4.2 the Seller shall not be liable to the Buyer for any indirect or consequential loss or damage (whether for loss of profits, loss of business, depletion of goodwill or otherwise), costs, expenses or other claims or consequential compensation whatsoever (howsoever caused) which arise out of or in connection with the Contract.

9. TIME FOR NOTIFYING DELIVERY SHORTAGES

9.1 The Seller shall not be liable in any way whatsoever for short delivery unless the Buyer notifies the Seller of any shortage within 3 working days of date of delivery or deemed delivery.

10. RISK AND TITLE

10.1 The Goods are at the risk of the Buyer from the date of delivery.

10.2 Ownership of the Goods shall not pass to the Buyer until the Seller has received in full (in cash or cleared funds) all sums due to it in respect of:

10.2.1 the Goods; and

10.2.2 all other sums which are or which become due to the Seller from the Buyer on any account.

10.3 Until the ownership of the Goods has passed to the Buyer, the Buyer must:

10.3.1 hold the Goods on a fiduciary basis as the Seller's bailee;

10.3.2 store the Goods (at no cost to the Seller) separately from all other goods of the Buyer or any third party in such a way that they remain readily identifiable as the Seller's property;

10.3.3 not destroy, deface or obscure any identifying mark or packaging on or relating to the Goods;

10.3.4 maintain the Goods in satisfactory condition and keep them insured on the Seller's behalf for their full price against all risk to the reasonable satisfaction of the Seller. On request the Buyer shall produce the policy of insurance to the Seller; and

10.3.5 hold the proceeds of the insurance referred to in condition 10.3.4 on trust for the Seller and not mix them with any other money, nor pay the proceeds into an overdrawn bank account.

10.4 If the Buyer :

10.4.1 has a bankruptcy order made against him or makes an arrangement or composition with his creditors, or otherwise takes the benefit of any statutory provision for the time being in force for the relief of insolvent debtors, or (being a body corporate) convenes a meeting of creditors (whether formal or informal), or enters into liquidation (whether voluntary or compulsory) except a solvent voluntary liquidation for the purpose only of reconstruction or amalgamation, or has a receiver and/or manager, administrator or administrative receiver appointed to its undertaking or any part thereof, or a resolution is passed or a petition presented to any court for the winding up of the Buyer or for the granting of an administration order in respect of the Buyer, or any proceedings are commenced relating to the insolvency or possible insolvency of the Buyer; or

10.4.2 suffers or allows any execution, whether legal or equitable, to be levied on his/its property or obtained against him/it, or fails to observe/performs any of his/its obligations under the Contract or any other contract between the Company and the Buyer, or is unable to pay its debts within the meaning of section 123 of the Insolvency Act 1986 or the Buyer ceases to trade; or

10.4.3 the Buyer encumbers or in any way charges any of the Goods; then the Buyer's right to possession of the Goods shall terminate immediately, the Seller shall immediately be entitled to the price and the Seller shall be entitled (without prejudice to its other claims and rights under the Contract) to suspend or cancel further deliveries or services under this Contract and any other contract between the Seller and the Buyer and treat the Contract as wholly repudiated by the Buyer and forthwith to terminate the Contract.

10.5 The Seller shall be entitled to recover payment for the Goods notwithstanding that ownership of any of the Goods has not passed from the Seller.

10.6 The Buyer grants the Seller, its agents and employees an irrevocable licence at any time to enter any premises where the Goods are or may be stored in order to inspect them, or, where the Buyer's right to possession has terminated, to recover them.

11. INDEMNITY

11.1 The Buyer shall indemnify the Seller against all claims and demands whatsoever made by any person or persons against the Seller in respect of injury, loss or damage arising directly or indirectly from the delivery and use of the Goods supplied by the Seller, howsoever caused and whether or not amounting to negligence.

12. GENERAL

12.1 Each right or remedy of the Seller under the Contract is without prejudice to any other right or remedy of the Seller whether under the Contract or not.

12.2 If any provision of the Contract is found by any court, tribunal or administrative body of competent jurisdiction to be wholly or partly illegal, invalid, void, voidable, unenforceable or unreasonable it shall to the extent of such illegality, invalidity, voidness, voidability, unenforceability or unreasonableness be deemed severable and the remaining provisions of the Contract and the remainder of such provision shall continue in full force and effect.

12.3 Any concession made by the Seller or waiver by the Seller of any breach of, or any default under, any provision of the Contract by the Buyer will not be construed as a waiver of any of its rights under the Contract.

12.4 Failure or delay by the Seller in enforcing or partially enforcing any provision of the Contract will not be construed as a waiver of any of its rights under the Contract.

12.5 The Seller reserves the right to correct any clerical errors made by its employees at any time.

12.6 The parties to this Contract do not intend that any term of this Contract will be enforceable by virtue of the Contracts (Rights of Third Parties) Act 1999 by any person that is not a party to it.

12.7 The formation, construction and performance of this contract shall be governed in all respects by English Law and the parties submit to the exclusive jurisdiction of the English courts.



Maypole Ltd, 162 Clapgate Lane, Woodgate Business Park, Birmingham B32 3DE
Tel: +44 (0) 121 270 4301 Fax: +44 (0) 121 423 3020 Email: sales@maypoleltd.co.uk
Web: www.maypoleltd.com www.stronghold-security.com

THE UK & IRELAND'S LEADING TOWING AND TOURING COMPANY